

Kwikset

Tylo Passage Lockset - Builder box pack. For all interior doors where a simple latch is all that is required. Plain knob on both sides. Turning either knob will retract latch bolt at all times to open door. Full 10 year mechanical warranty. 5 year finish warranty.



Product No.	Mfg. No.	Description	Order Mult.	Weight	Unit Cost
229602-B	200T 3	2-3/8" backset, square face, plain latch, polished brass (3) finish	1/0/30	1.100	9.49 EA
218596-B	200T 3	6-way steel adjustable latch (AL), interchangeable for 2-3/8" or 2-3/4" backsets, drive-in (round), radius, or square face plain latch, polished brass (3)	1/0/30	1.100	9.49 EA

Kwikset

Tylo Privacy Lockset - Builder box pack. For bedroom and bathroom doors. Turn button on interior knob. Turning button locks both knobs. Lock may be opened by an emergency entry key in exterior knob. Full 10 year mechanical warranty. 5 year finish warranty.



Product No.	Mfg. No.	Description	Order Mult.	Weight	Unit Cost
229611-B	300T 3	2-3/8" backset, square face plain latch, polished brass (3) finish	1/0/30	.998	9.99 EA
218626-B	300T 5	2-3/8" steel backset, radius corner latch, polished brass (3) finish	1/0/30	.997	9.99 EA

Kwikset

Tylo Entry Lockset - Builder box pack. Polished brass (3) finish. Packaged with a 2-3/8" backset square face deadlatch, 2-3/8" backset 1/4" radius deadlatch (RCL/S), or 2-3/4" backset square face deadlatch. Entry backset for keyed exterior doors. Key from exterior and turn button from interior will lock or unlock exterior knob or interior knob. Full 10 year mechanical warranty. 5 year finish warranty. Keying information: K3 - keyed alike set of 3.



Product No.	Mfg. No.	Description	Order Mult.	Weight	Unit Cost
229639-A	400T 3 6AL RCS	6-way steel adjustable latch (AL), interchangeable for 2-3/8" or 2-3/4" backsets, drive-in (round), radius, or square face plain latch, polished brass (3)	1/0/30	1.242	11.99 EA
210113-A	400T 3 6AL RCS K2	6-way steel adjustable latch (AL), interchangeable for 2-3/8" or 2-3/4" backsets, drive-in (round), radius, or square face plain latch, polished brass (3), keyed alike set of 2 (K2)	2/0/30	1.250	11.99 EA
229648-A	400T 3 6AL RCS K3	6-way steel adjustable latch (AL), interchangeable for 2-3/8" or 2-3/4" backsets, drive-in (round), radius, or square face plain latch, polished brass (3), keyed alike set of 5 (K3)	3/0/30	1.263	11.99 EA

Kwikset

Polo Passage Lockset - Builder box pack. For all interior doors where a simple latch is all that is required. Plain knob on both sides. Turning either knob will retract latch bolt at all times to open door. Full 10 year mechanical warranty. 5 year finish warranty.



Product No.	Mfg. No.	Description	Order Mult.	Weight	Unit Cost
218766-B	200P 3 RCAL RCS	6-way steel adjustable latch (AL), interchangeable for 2-3/8" or 2-3/4" backsets, drive-in (round), radius, or square face plain latch, polished brass (3)	1/0/30	.867	10.99 EA
203459-B	200P 3	2-3/8" backset, plain latch, polished brass (3)	1/0/30	.867	10.99 EA

Kwikset

Passage and Privacy Round Sliding Door Lock - Round pocket door latch is easy-to-install. Nothing to mark, nothing to cut. Only requires a screwdriver. Keeps door from warping. Privacy function always engages when closed. Deep cups for easy access. Backset 2-3/8", adjustable door thickness 1-3/8" to 1-3/4", strike is 1-1/8" x 2-1/4", square corner. Lifetime mechanical warranty and 10 year finish warranty.



Product No.	Mfg. No.	Description	Order Mult.	Weight	Unit Cost
201016-B	334	Passage polished brass (3), used where no locking is required	1/0/12	.667	15.59 EA
201007-B	334	Passage satin nickel (15), used where no locking is required	1/0/12	.667	16.69 EA
201034-A	335	Privacy polished brass (3), used on bathroom and bedroom doors	1/0/12	.667	16.69 EA
201025-B	335	Privacy satin nickel (15), used on bathroom and bedroom doors	1/0/12	.667	17.79 EA

Kwikset

Polo Entry Lockset - Builder box pack. Packaged with a 2-3/8" backset square face deadlatch, 2-3/8" backset 1/4" radius deadlatch (RCL/S), or 2-3/4" backset square face deadlatch. Entry lockset for keyed exterior doors. Key from exterior and turn button from interior will lock or unlock exterior knob or interior knob. Full 10 year mechanical warranty. 5 year finish warranty.



Product No.	Mfg. No.	Description	Order Mult.	Weight	Unit Cost
203718-A	400P 3 6AL RCS	6-way steel adjustable latch (AL), interchangeable for 2-3/8" or 2-3/4" backsets, drive-in (round), radius, or square face plain latch, polished brass (3)	1/0/30	1.267	13.49 EA
203475-A	400P 3 6AL RCS K6	6-way steel adjustable latch (AL), interchangeable for 2-3/8" or 2-3/4" backsets, drive-in (round), radius, or square face plain latch, polished brass (3), keyed alike set of 6 (K6)	6/0/30	1.267	13.49 EA

HARDWARE

Kwikset

Tylo Entry Lockset - Consumer clear pack. Entry lockset for keyed exterior doors. Key from exterior and turn button from interior will lock or unlock exterior knob or interior knob. Full 10 year mechanical warranty. 5 year finish warranty.



Product No.	Mfg. No.	Description	Order Mult.	Weight	Unit Cost
203289-A	400T 3	6-way adjustable latch (AL), interchangeable for 2-3/8" or 2-3/4" backsets, drive-in (round), radius, or square face plain latch, polished brass (3)	1/0/6	1.333	11.99 EA
203297-A	400T 3 K2	6-way steel adjustable latch (AL), interchangeable for 2-3/8" or 2-3/4" backsets, drive-in (round), radius, or square face plain latch, polished brass (3), keyed alike set of 2 (K2)	2/0/6	1.333	11.99 EA
203270-B	400T 5	6-way steel adjustable latch (AL), interchangeable for 2-3/8" or 2-3/4" backsets, drive-in (round), radius, or square face plain latch, antique brass (5)	1/0/6	1.333	13.99 EA
203262-B	400T 5 K2	6-way steel adjustable latch (AL), interchangeable for 2-3/8" or 2-3/4" backsets, drive-in (round), radius, or square face plain latch, antique brass (5), keyed alike set of 2 (K2)	2/0/6	1.333	13.99 EA
219576-B	400T 26D	6-way steel adjustable latch (AL), interchangeable for 2-3/8" or 2-3/4" backsets, drive-in (round), radius, or square face plain latch, satin chrome (26D)	1/0/6	1.333	13.99 EA
219584-B	400T 26D K2	6-way steel adjustable latch (AL), interchangeable for 2-3/8" or 2-3/4" backsets, drive-in (round), radius, or square face plain latch, satin chrome (26D), keyed alike set of 2 (K2)	2/0/6	1.333	13.99 EA

Kwikset

Polo Dummy Lockset - Builders box pack. Polished brass (3) finish. For use on doors where only a pull is required. Full 10 year mechanical warranty. 5 year finish warranty.



Product No.	Mfg. No.	Description	Order Mult.	Weight	Unit Cost
218693-E	488P 3	Polo Dummy Lockset	1/0/20	.150	6.99 EA

Kwikset

Belair Storeroom Or Vestibule Kwikset Plus Lockset -

Box pack. Polished brass (3) finish. 2-way steel adjustable latch 2-3/4" and 2-3/8" square face backset with square corner latch and strike. For service doors or common entry exterior doors. Inside knob is always free turning for immediate exit. Complies with ANSI F86. Lifetime mechanical warranty. 5 year finish warranty.

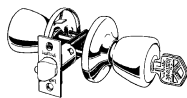

Product No.	Mfg. No.	Description	Order Mult.	Weight	Unit Cost
212776-B	450B 3 2-3/8	Vestibule Lockset	1/0/30	1.233	22.99 EA

Do It Best Imports/ Steel Pro

Single Cylinder Deadbolt - Consumer clear pack. Packaged with an adjustable latch, interchangeable for 2-3/8" or 2-3/4" backsets. Square face deadbolt latch. 1" hardened throw deadbolt. Key retracts bolt from exterior turnpiece operates bolt from interior. Uses Kwikset keyway. Order a case of 12 and receive 4 sets of 3 keyed alike. Uses Kwikset keyway.



Product No.	Mfg. No.	Description	Order Mult.	Weight	Unit Cost
239089-C	D101PB CP	Polished brass (PB)	1/6/24	1.192	8.99 EA
246883-D	D101 SS	Satin chrome (SC)	1/6/24	1.192	9.29 EA
256366-D	D101AB CP	Antique brass (AB)	1/6/24	1.167	9.49 EA
208867-D	D101SN CP	Satin nickel (SN)	1/6/24	1.167	9.49 EA
223085-D	D101AN CP	Antique nickel	1/6/24	1.333	10.99 EA
223107-D	D101ORB CP	Oil rubbed bronze	1/6/24	1.333	10.99 EA

Do It Best Imports/ Steel Pro

Double Cylinder Deadbolt - Consumer clear pack. Packaged with an adjustable latch, interchangeable for 2-3/8" or 2-3/4" backsets. Square face deadbolt latch. 1" hardened throw deadbolt. Key retracts bolt from exterior and interior. Uses Kwikset keyway. Order a case of 12 and receive 4 sets of 3 keyed alike. Uses Kwikset keyway.



Product No.	Mfg. No.	Description	Order Mult.	Weight	Unit Cost
239097-D	D102PB CP	Polished brass (PB)	1/6/24	1.375	10.49 EA
222770-D	D102ORB CP	Oil rubbed bronze	1/6/24	1.417	12.49 EA
223077-D	D102AN CP	Antique nickel	1/6/24	1.417	12.49 EA
223671-D	D102SN CP	Satin nickel	1/6/24	1.417	11.99 EA

Kwikset

Single Cylinder Deadbolt - Builder box pack. Key retracts bolt from exterior, turnpiece operates bolt from interior. Full 10 year mechanical warranty. 5 year finish warranty.

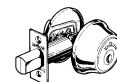

Product No.	Mfg. No.	Description	Order Mult.	Weight	Unit Cost
201757-A	660 3	2-3/8" and 2-3/4" radius corner adjustable latch (RCAL) radius corner strike, polished brass (3)	2/0/12	1.000	13.39 EA
238651-A	660 5	2-3/8" backset, 1/4" radius deadbolt latch (RCL/S), keyed alike set of 2, antique brass (5) finish	2/0/12	1.000	14.49 EA

Kwikset

Double Cylinder Deadbolt - Builder box pack. Polished brass (3) finish. Packaged with a 2-3/8" backset square face deadbolt latch, 2-3/8" backset 1/4" radius deadbolt latch (RCL/S), or with a 2-3/4" backset square face deadbolt latch. Key retracts bolt from exterior and interior. Full 10 year mechanical warranty. 5 year finish warranty. Keying information: K2 - keyed alike set of 2.



Product No.	Mfg. No.	Description	Order Mult.	Weight	Unit Cost
206997-A	665 3 K2 AL	Double Cylinder Deadbolt	2/0/12	1.583	17.49 EA
238627-A	665 3 KD	Double Cylinder Deadbolt	1/0/12	1.333	17.49 EA

Some prices shown may vary due to market fluctuations, and are to be used as estimates.

Kwikset

Hancock Passage Lockset - Builder box pack. Polished brass (3) finish. Packaged with a 6-way steel adjustable latch 2-3/8" backset square face plain latch, or with a 2-3/8" backset 1/4" radius plain latch (RCL/S). For all interior doors where a simple latch is all that is required. Plain knob on both sides. Turning either knob will retract latch bolt at all times to open door. Grade 2 construction for superior durability and quality performance. Full 50 year mechanical warranty. 10 year finish warranty.



Product No.	Mfg. No.	Description	Order Mult.	Weight	Unit Cost
232904-C	720H 3	Hancock Passage Lockset	1/0/12	2.250	15.99 EA

Kwikset

Hancock Privacy Lockset - Builder box pack. Polished brass (3) finish. Packaged with a 6-way adjustable latch 2-3/8" backset square face plain latch, or with a 2-3/8" backset 1/4" radius plain latch (RCL/S). For bedroom and bathroom doors. Turn button on interior knob. Turning button locks both knobs. Lock may be opened by an emergency entry key in exterior knob. Grade 2 construction for superior durability and quality performance. Full 50 year mechanical warranty. 10 year finish warranty.



Product No.	Mfg. No.	Description	Order Mult.	Weight	Unit Cost
232920-C	730H 3	Hancock Privacy Lockset	1/0/12	2.250	17.99 EA

Kwikset

Single Cylinder Deadbolt - Builder box pack. Available in lifetime polished brass (L03) finish. Key retracts bolt from exterior, turnpiece operates bolt from interior. Grade 2 construction for superior durability and quality performance. 6-pin cylinder for greater security. Lifetime mechanical and finish warranty. For 2-3/8" or 2-3/4" backset, (RCAL) (RCS), keyed alike set of 3.

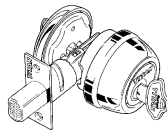

Product No.	Mfg. No.	Description	Order Mult.	Weight	Unit Cost
224790-B	780 L03 K3	Single Cylinder Deadbolt	3/0/12	2.250	27.99 EA

Kwikset

Double Cylinder Deadbolt - Builder box pack. Available in lifetime polished brass (L03) finish. Packaged with adjustable 2-3/8" or 2-3/4" backset, 1/4" radius deadbolt latch. Key retracts bolt from exterior and interior. Grade 2 construction for superior durability and quality performance. 6-pin cylinder for greater security. Lifetime mechanical and finish warranty.

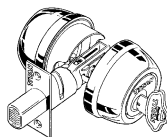

Product No.	Mfg. No.	Description	Order Mult.	Weight	Unit Cost
224677-D	785 3 K3	Double Cylinder Deadbolt	1/0/12	2.750	46.99 EA

Kwikset

Deadbolt - Consumer clear pack. Packaged with adjustable latch (AL), interchangeable for 2-3/8" or 2-3/4" backset with radius corner face latch. 1" throwbolt protects against kick-ins with twice the strength. Free spinning guard. Grade 2 construction for superior durability and quality performance. 5-pin cylinder for greater security. Lifetime mechanical warranty.



Product No.	Mfg. No.	Description	Order Mult.	Weight	Unit Cost
234168-B	970 5 CP K2	Single cylinder, antique brass (5), keyed alike in set of 2	2/0/6	1.917	22.99 EA
201043-C	970 15 CP K6	Single cylinder, satin nickel (15) finish, code K6: Order case of 6 and receive 2 sets of 3 keyed alike, 10 year finish warranty	1/0/6	2.770	26.49 EA
251690-C	970CP	Single cylinder, antique nickel (15A), code K3: Order case of 6, receive 2 sets of 3 each keyed alike	1/0/6	2.770	26.49 EA
251682-C	780CP-26D	Single cylinder, satin chrome (26D) code K3: Order case of 6, receive 2 sets of 3 each keyed alike	1/0/6	2.770	26.49 EA
224669-A	970 3 CP K2	Single cylinder, polished brass (3) finish, adjustable latch, keyed alike in set of 2	2/0/6	2.770	19.99 EA
234184-B	975 5 CP K2	Double cylinder, antique brass (5), keyed alike in set of 2, lifetime finish warranty	2/0/6	2.770	26.99 EA
224642-B	975CP 3 K2	Double cylinder, polished brass (3), keyed alike in set of 2, lifetime finish warranty	2/0/6	2.770	25.99 EA

**YOUR
Single
Source
Supplier!**

Kwikset

Signature Series Deadbolt - Consumer clear pack. Deadbolt operated by key outside and thumbturn inside. ANSI Grade 1. Ultra Max Security™ features 5-pin cylinder with pick-resistant pins, an ultra strike door Jamb Brace™ and a 1" brass throw deadbolt with a titanium alloy core. Consumer preferred *ballistic* design and concealed screws (on single cylinder). Lifetime anti-tarnish polished brass finish. Lifetime mechanical warranty.



Product No.	Mfg. No.	Description	Order Mult.	Weight	Unit Cost
200080-A	980S L03 CP K2	Single cylinder, lifetime polished brass (L03), keyed alike in set of 2	2/0/6	2.620	31.59 EA
203176-B	980S 15 CP K6	Single cylinder, satin nickel (15) finish, code K6, order case of 6 and receive 2 sets of 3 keyed alike, 10 year finish warranty	1/0/6	2.620	34.79 EA
220898-B	980S 15A CP K6	Single cylinder, antique nickel (15) finish, code K6, order case of 6 and receive 2 sets of 3 keyed alike, 10 year finish warranty	1/0/6	2.620	34.79 EA
220861-B	980S 11P CP K6	Single cylinder, venetian bronze (11P) finish, code K6, order case of 6 and receive 2 sets of 3 keyed alike, 10 year finish warranty	1/0/6	2.620	36.99 EA
213726-B	980S 26D CP K6	Single cylinder, satin chrome (26D), code K6, order case of 6 and receive 2 sets of 3 keyed alike, 10 year finish warranty	1/0/6	1.310	34.79 EA
200099-A	985S L03 CP K6	Double cylinder, lifetime polished brass (L03) finish, code K6, order case of 6 and receive 2 sets of 3 keyed alike, 10 year finish warranty	2/0/6	2.620	43.99 EA
207421-A	985S 15 CP K6	Double cylinder, satin nickel (15) finish, code K6, order case of 6 and receive 2 sets of 3 keyed alike, 10 year finish warranty	1/0/6	2.620	43.99 EA
220870-A	985S 11P CP K6	Double cylinder, venetian bronze (11P) finish, code K6, order case of 6 and receive 2 sets of 3 keyed alike, 10 year finish warranty	1/0/6	2.620	43.99 EA

Kwikset

Lido Dummy Leverset - Consumer clear pack. Lido dummy leversets are handed, select left hand (LH) or right hand (RH) depending on door swing (see note). For use on doors where only a pull is required. Lifetime mechanical warranty. 5 year finish warranty. How to determine the hand of a door: The hand of a door is always determined by facing the outside of a door. If the hinge is on the left side of the door, the door is left handed (LH). If the hinge is on the right side of the door, the door is right handed (RH). To order a handed product, specify LH or RH. Not all products are handed; only specify handing when required.



Product No.	Mfg. No.	Description	Order Mult.	Weight	Unit Cost
219312-B	488LL	CP-3 RH, polished brass (3)	1/0/4	.350	9.49 EA

Kwikset

Dakota Entry Handleset - Sectional handleset with single cylinder deadbolt. Interior knob is Polo style. Full 1" solid core throwbolt. All-metal mechanisms. Anti-pry shield. Deadbolt: Backset adjustable 2-3/8" or 2-3/4", strike 1" x 2-1/4" round corner bolts - 1" throw. Handle: Backset dual 2-3/8" - 2-3/4" plain latch standard, strike 2-1/4" full lip round corner, 1/2" handle throw. 5-pin cylinder. Limited lifetime warranty.



Product No.	Mfg. No.	Description	Order Mult.	Weight	Unit Cost
200062-B	687DAXP CP 3	Solid forged brass (3)	1/0/2	3.000	69.00 EA
213600-B	687DAXP CP 15	Satin nickel (15)	1/0/2	3.000	79.00 EA

Kwikset

Installation Kit - All-in-one boring jig. Unique design for drilling wood, fiberglass, and metal doors. Drills 2-1/8" and 1-1/2" standard door prep. In-line arm for wood and metal doors. 2-1/8" multi-spur bit and 2-1/8" metal hole saw. 1" heavy-duty Dewalt® spade bit. 1-1/2" multi-spur bit. Depth stop guide. 1-1/2" adapter ring. Quick drill bit adapter. Strike mortise tool with square and round corner replaceable blades. Strike locator. Titan® strike mortise tool with square and round corner replaceable blades. Latch mortise tool with square and round corner replaceable blades. C-clip. Aluminum template measuring guide. Heavy-duty kit box. Trouble-free setup. Molded kit box holds assembled jig. No assembly or tear-down required. Ergonomic handle design ensures firm clamping.

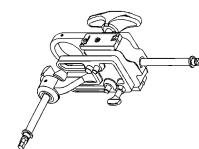

Product No.	Mfg. No.	Description	Order Mult.	Weight	Unit Cost
254649-B	138	Installation Kit	0/0/1	15.230	284.99 EA

WEISER LOCK

Powerbolt 1000 Electronic Deadbolt - Visual pack. Electronic keyless system. Touch keypad offers easy locking using programmable codes. Key also retracts bolt from exterior; turn piece operates bolt from interior. Heavy-duty security deadbolt and strike plate resist break-ins. Easy-to-install and program. Fits in standard door hardware preparation. No wiring necessary. Square corner. Universal latch packaged with a 1" square corner, 1/4" round corner, and 1" circular drive-in deadbolt, adjustable for 2-3/8" or 2-3/4" backsets. 1-1/8" x 2-3/4" x 1-1/16" radius strike. Brilliance lifetime finish eliminates tarnishing, flaking, pitting, and discoloring. Keyed different. Polished brass (3) finish.



Product No.	Mfg. No.	Description	Order Mult.	Weight	Unit Cost
202587-B	ED1460X3VKD	Powerbolt Elec Deadbolt	1/0/6	2.967	129.00 EA

Schlage Lock

Bell Passage Lockset - Box pack. For all interior doors where a simple latch is all that is required. Plain knob on both sides. Turning either knob will retract latch bolt at all times to open door. Bright brass finish. Packaged with 1" square corner, 1/4" radius corner, and 1" circular drive-in latch, adjustable for 2-3/8" or 2-3/4" backsets. Square corner and radius corner strikes included. Grade 2 construction for superior durability and quality performance. Lifetime mechanical warranty. 10 year finish warranty.



Product No.	Mfg. No.	Description	Order Mult.	Weight	Unit Cost
231266-B	F10BEL605	Bell Passage Lockset	1/0/20	1.233	11.99 EA

Schlage Lock

Bell Privacy Lockset - Box pack. For bathroom and bedroom doors. Outside knob locked by inside button. Push-button locking. Unlocked by turning knob or from outside with narrow tool. Bright brass finish. Packaged with 1" square corner, 1/4" radius corner, and 1" circular drive-in latch. 2-3/8" or 2-3/4" backsets. Square corner and radius corner strikes included. Grade 2 construction for superior durability and quality performance. Lifetime mechanical warranty. 10 year finish warranty.



Product No.	Mfg. No.	Description	Order Mult.	Weight	Unit Cost
231290-B	F40BEL605	Bell Privacy Lockset	1/0/20	1.233	13.99 EA

Schlage Lock

Bell Entry Lockset - Box pack. For keyed exterior doors. Unlocked by key from outside when outer knob is locked by turn-button in inner knob. Bright brass finish. Packaged with 1" square corner, 1/4" radius corner, and 1" circular drive-in latch, adjustable for 2-3/8" or 2-3/4" backsets. Square corner and radius corner strikes included. Keyed alike in sets of 4. Grade 2 construction for superior durability and quality performance. Lifetime mechanical warranty. 10 year finish warranty.



Product No.	Mfg. No.	Description	Order Mult.	Weight	Unit Cost
231339-B	F51BEL605K4	Bell Entry Lockset	4/0/20	1.575	22.99 EA

Schlage Lock

Bell Dummy Knob - Box pack. Single. For door pull or matching trim. Bright brass finish. Grade 2 construction for superior durability and quality performance. 10 year finish warranty.



Product No.	Mfg. No.	Description	Order Mult.	Weight	Unit Cost
231363-E	F170BEL605	Bell Dummy Knob	1/0/30	.367	8.79 EA

Schlage Lock

Plymouth Passage Lockset - Box pack. For all interior doors where a simple latch is all that is required. Plain knob on both sides. Turning either knob will retract latch bolt at all times to open door. Bright brass finish. Packaged with 1" square corner, 1/4" radius corner, and 1" circular drive-in latch, adjustable for 2-3/8" or 2-3/4" backsets. 1" square corner spring latch. Square corner and radius corner strikes included. Grade 2 construction for superior durability and quality performance. Lifetime mechanical warranty. 10 year finish warranty.



Product No.	Mfg. No.	Description	Order Mult.	Weight	Unit Cost
231134-B	F10PLY605	Plymouth Passage Lockset	1/0/20	1.233	12.99 EA

Schlage Lock

Plymouth Privacy Lockset - Box pack. For bathroom and bedroom doors. Outside knob locked by inside button. Push-button locking. Unlocked by turning knob or from outside with narrow tool. Packaged with 1" square corner, 1/4" radius corner, and 1" circular drive-in latch, adjustable for 2-3/8" or 2-3/4" backsets. Square corner and radius corner strikes included. Grade 2 construction for superior durability and quality performance. Lifetime mechanical warranty. 10 year finish warranty.



Product No.	Mfg. No.	Description	Order Mult.	Weight	Unit Cost
231169-B	F40PLY605	Bright brass (605) finish	1/0/20	1.233	14.99 EA
254150-C	F40PLY605X625	Bright brass (605) xbright chromium (625) finish	1/0/20	2.075	18.49 EA

Schlage Lock

Plymouth Entry Lockset - Box pack. For keyed exterior doors. Unlocked by key from outside when outer knob is locked by turn-button in inner knob. Inside knob is always unlocked. Bright brass finish. Packaged with 1" square corner, 1/4" radius corner, and 1" circular drive-in latch, adjustable for 2-3/8" or 2-3/4" backsets. Square corner and radius corner strikes included. Keyed alike in sets of 4. Grade 2 construction for superior durability and quality performance. Lifetime mechanical warranty. 10 year finish warranty. Order a case of 20 and you will get 5 sleeves of 4. Each sleeve of 4 will be keyed alike.



Product No.	Mfg. No.	Description	Order Mult.	Weight	Unit Cost
231215-B	F51PLY605	Plymouth Entry Lockset	1/0/20	1.575	24.99 EA

Schlage Lock

Plymouth Dummy Knob - Box pack. Single. For door pull or matching trim. Bright brass finish. Grade 2 construction for superior durability and quality performance. 10 year finish warranty.



Product No.	Mfg. No.	Description	Order Mult.	Weight	Unit Cost
231258-D	F170PLY605	Plymouth Dummy Knob	1/0/30	.367	7.99 EA

Schlage Lock

Georgian Passage Lockset - Box pack. For all interior doors where a simple latch is all that is required. Plain knob on both sides. Turning either knob will retract latch bolt at all times to open door. Packaged with 1" square corner, 1/4" radius corner, and 1" circular drive-in latch, adjustable for 2-3/8" or 2-3/4" backsets. Square corner and radius corner strikes included. Grade 2 construction for superior durability and quality performance. Lifetime mechanical warranty.



Product No.	Mfg. No.	Description	Order Mult.	Weight	Unit Cost
230987-B	F10GEO605	Bright brass (605) finish, 10 year finish warranty	1/0/20	1.233	12.99 EA
231371-B	F10GEO609	Antique brass (609) finish, 10 year finish warranty	1/0/20	1.233	15.99 EA

Schlage Lock

Georgian Privacy Lockset - Box pack. For bathroom and bedroom doors. Outside knob locked by inside button. Push-button locking. Unlocked by turning knob or from outside with narrow tool. Packaged with 1" square corner, 1/4" radius corner, and 1" circular drive-in latch, adjustable for 2-3/8" or 2-3/4" backsets. Square corner and radius corner strikes included. Grade 2 construction for superior durability and quality performance. Lifetime mechanical warranty.



Product No.	Mfg. No.	Description	Order Mult.	Weight	Unit Cost
231037-B	F40GEO605	Bright brass (605) finish, 10 year finish warranty	1/0/20	1.233	14.99 EA
231428-B	F40GEO609	Antique brass (609) finish, 10 year finish warranty	1/0/20	1.233	17.99 EA

Schlage Lock

Georgian Entry Lockset - Box pack. For keyed exterior doors. Unlocked by key from outside when outer knob is locked by turn-button in inner knob. Packaged with 1" square corner, 1/4" radius corner, and 1" circular drive-in latch, adjustable for 2-3/8" or 2-3/4" backsets. Square corner and radius corner strikes included. Keyed alike in sets of 4. Grade 2 construction for superior durability and quality performance. Lifetime mechanical warranty. Order a case of 20 and you will get 5 sleeves of 4. Each sleeve of 4 will be keyed alike.



Product No.	Mfg. No.	Description	Order Mult.	Weight	Unit Cost
231088-B	F51GEO605	Bright brass (605) finish, 10 year finish warranty	1/0/20	1.575	23.99 EA
231460-A	F51GEO609	Antique brass (609) finish, 10 year finish warranty	1/0/20	1.575	22.99 EA

Schlage Lock

Georgian Dummy Knob - Box pack. Single. For door pull or matching trim. Grade 2 construction for superior durability and quality performance.



Product No.	Mfg. No.	Description	Order Mult.	Weight	Unit Cost
231126-C	F170GEO605	Bright brass (605) finish, 10 year finish warranty	1/0/30	.367	6.99 EA
231495-D	F170GEO609	Antique brass (609) finish, 10 year finish warranty	1/0/30	.367	8.99 EA

Schlage Lock

Flair Passage Leverset - Box pack. For all interior doors where simple latch is all that is required. Plain lever on both sides. Turning lever will retract latch bolt at all times to open door. Packaged with a 1" square corner, 1/4" round corner, and 1" circular drive-in plain latch, adjustable for 2-3/8" or 2-3/4" backsets. 2-1/4" x 1-3/4" full-lip square corner strike. Grade 2 construction for superior durability and quality performance. Lifetime mechanical warranty. 10 year finish warranty. Reversible levers eliminate the need to determine *right hand* or *left hand* installation. Easy-to-install, 3-piece assembly. ADA compliant.



Product No.	Mfg. No.	Description	Order Mult.	Weight	Unit Cost
217410-B	F10FLA605	Bright brass (605)	1/0/20	2.113	21.99 EA

Schlage Lock

Flair Privacy Leverset - Box pack. For bathroom and bedroom doors. Outside lever locked by inside button. Push-button locking. Unlock by turning lever or from outside with narrow tool. Packaged with a 1" square corner, 1/4" round corner, and 1" circular drive-in spring latch, adjustable for 2-3/8" or 2-3/4" backsets. 2-1/4" x 1-3/4" full-lip square corner strike. Grade 2 construction for superior durability and quality performance. Lifetime mechanical warranty. 10 year finish warranty. Reversible levers eliminate the need to determine *right hand* or *left hand* installation. Easy-to-install, 3-piece assembly. ADA compliant.



Product No.	Mfg. No.	Description	Order Mult.	Weight	Unit Cost
217465-A	F40FLA605	Bright brass (605)	1/0/20	2.113	22.99 EA

Schlage Lock

Plymouth Flair Entry Lockset - Box pack. For keyed exterior doors. Unlocked by key from outside when outer knob is locked by turn-button in inner lever. Bright brass finish. Packaged with a 1" square corner, 1/4" radius corner, and 1" circular drive-in deadlatch, adjustable for 2-3/8" or 2-3/4" backsets. Square corner and radius corner strikes included. Grade 2 construction for superior durability and quality performance. Lifetime mechanical warranty. 10 year finish warranty. Order a case of 20 and you will get 5 sleeves of 4. Each sleeve of 4 will be keyed alike.



Product No.	Mfg. No.	Description	Order Mult.	Weight	Unit Cost
242969-C	F51PLYXFLA605	Plymthxflair Rh Lockset	1/0/20	1.750	31.99 EA
242977-C	F51PLYXFLA605	Plymthxflair Lh Lockset	1/0/20	1.750	31.99 EA

Schlage Lock

Flair Entry Leverset - Box pack. Entry leverset for keyed exterior doors. Unlocked by key from outside when out lever is locked by turn button in inside lever. Packaged with a 1" square corner, 1/4" round corner, and 1" circular drive-in dead latch, adjustable for 2-3/8" or 2-3/4" backsets. 2-1/4" x 1-3/4" full-lip square corner strike. Grade 2 construction for superior durability and quality performance. Lifetime mechanical warranty. Meets ADA specifications for handicapped levers. Order a case of 20 and you will get 5 sleeves of 4. Each sleeve of 4 will be keyed alike. Reversible levers eliminate the need to determine *right hand* or *left hand* installation. Easy-to-install, 3-piece assembly. ADA compliant.



Product No.	Mfg. No.	Description	Order Mult.	Weight	Unit Cost
217483-B	F51FLA605	Bright brass (605)	1/4/20	2.113	44.99 EA

Schlage Lock

Flair Dummy Leverset - Box pack. For door pull or matching trim. 10 year finish warranty.



Product No.	Mfg. No.	Description	Order Mult.	Weight	Unit Cost
246514-C	F170FLA605RH	Bright brass (605)	1/0/30	.700	11.99 EA
246506-C	F170FLA605LH	Antique brass (609)	1/0/30	.700	11.99 EA

Schlage Lock

Plymouth Grip Handle Set - Visual pack. Interior knob is Bell.

Deadbolt thrown or retracted by key outside or by turn unit inside. Latch by thumbpiece from outside or by knob from inside. Bright brass finish. Packaged with a 1" square corner, 1/4" round corner, and 1" circular drive-in deadbolt, adjustable for 2-3/8" or 2-3/4" backsets. 2-1/4" x 1-3/4" full-lip square corner strike. Grade 1 security features. Lifetime mechanical and 10 year finish warranty.



Product No.	Mfg. No.	Description	Order Mult.	Weight	Unit Cost
248347-C	F360VPLY505BE L605	Plymouth Grip Handleset	0/0/1	6.880	139.00 EA

Schlage Lock

Plymouth Grip Handle Set - Visual pack. Interior knob is

Plymouth. Deadbolt thrown or retracted by key outside or by turn unit inside. Latch by thumbpiece from outside or by knob from inside. Bright brass finish. Packaged with a 1" square corner, 1/4" round corner, and 1" circular drive-in deadbolt, adjustable for 2-3/8" or 2-3/4" backsets. 2-1/4" x 1-3/4" full-lip square corner strike. Grade 1 security features. Lifetime mechanical and 10 year finish warranty.



Product No.	Mfg. No.	Description	Order Mult.	Weight	Unit Cost
248339-A	F360VPLY505XP LY605	Plymouth Grip Handleset	0/0/1	6.880	109.00 EA

Schlage Lock

Plymouth Grip Handle Set - Visual pack. Interior lever is Flair.

Deadbolt thrown or retracted by key outside or by turn unit inside. Latch by thumbpiece from outside or by lever from inside. Ultima bright brass (505) x bright brass (605) finish. Packaged with a 1" square corner, 1/4" round corner, and 1" circular drive-in deadbolt, adjustable for 2-3/8" or 2-3/4" backsets. 2-1/4" x 1-3/4" full-lip square corner strike. Grade 1 security features. Lifetime mechanical warranty and finish. Reversible levers eliminate the need to determine *right hand* or *left hand* installation. Easy-to-install, 3-piece assembly. ADA compliant.



Product No.	Mfg. No.	Description	Order Mult.	Weight	Unit Cost
217580-B	F360VPLY505XFL A605	Plymouth Grip Handleset	0/0/1	6.900	119.00 EA

Schlage Lock

Bowman Grip Handle Set - Visual pack. Interior knob is Plymouth.

Deadbolt thrown or retracted by key outside or by turn unit inside. Latch by thumbpiece from outside or by knob from inside. Bright brass finish. Packaged with a 1" square corner, 1/4" round corner, and 1" circular drive-in deadbolt, adjustable for 2-3/8" or 2-3/4" backsets. 2-1/4" x 1-3/4" full-lip square corner strike. Grade 1 security features. Lifetime mechanical and finish warranty.



Product No.	Mfg. No.	Description	Order Mult.	Weight	Unit Cost
248363-B	F360VBOW505X PLY605	Bowman Grip Handleset	0/0/1	6.880	129.00 EA

Schlage Lock

Parthenon Grip Handle Set - Visual pack. Interior knob is

Georgian. Deadbolt thrown or retracted by key outside or by turn unit inside. Latch by thumbpiece from outside or by knob from inside. Antique brass finish. Packaged with a 1" square corner, 1/4" round corner, 1" circular drive-in deadbolt, adjustable for 2-3/8" or 2-3/4" backsets. 2-1/4" x 1-3/4" full-lip square corner strike. Grade 1 security features. Lifetime mechanical and finish warranty.



Product No.	Mfg. No.	Description	Order Mult.	Weight	Unit Cost
248355-C	F360VPAR609XG E0609	Parthenon Grip Handleset	0/0/1	6.880	129.00 EA

Schlage Lock

Strike - Carded. 2-1/4" x 1-3/4" full-lip. Bright brass finish.



Product No.	Mfg. No.	Description	Order Mult.	Weight	Unit Cost
231738-D	40-200605-F	Square Strike	1/0/12	.088	5.29 EA

Schlage Lock

Strike - Carded. 1/4" RC, 2-1/4" x 1-3/4" full-lip. Bright brass finish.



Product No.	Mfg. No.	Description	Order Mult.	Weight	Unit Cost
231746-D	40-201605-F	Round Strike	1/0/12	1.050	5.29 EA

Schlage Lock

Triple Option Universal Spring Latch - Carded. Replaces 1" square corner, 1/4" round corner, or 1" circular drive-in. For Schlage F series privacy and passage locksets. Adjustable for 2-3/8" or 2-3/4" backsets. Square corner and round corner are bright brass finish. Circular drive-in is satin chromium finish.



Product No.	Mfg. No.	Description	Order Mult.	Weight	Unit Cost
231754-D	40-250605-F	Universal Latch Spring	1/0/12	.333	10.49 EA

Schlage Lock

Triple Option Universal Dead Latch - Carded. Replaces 1" square corner, 1/4" round corner, or 1" circular drive-in. For Schlage F series entry locksets. Adjustable for 2-3/8" or 2-3/4" backsets. Square corner and round corner are bright brass finish. Circular drive-in is satin chromium finish.



Product No.	Mfg. No.	Description	Order Mult.	Weight	Unit Cost
231789-D	40-251605-F	Universal Dead Latch	1/0/12	.333	11.79 EA

Tell Mfg. Inc.

SV Series Passage Lockset - Visual pack. For commercial and industrial interior doors where a simple latch is all that is required. Plain knob on both sides. Turning either knob will retract latchbolt at all times to open door. Satin stainless steel finish. SV Series standard duty cylindrical knob and SK Series lever locksets for light commercial applications. UL listed for A label (3-hour) single swing door. Complies with ANSI A 156.2, Series 4000, Grade 2. Stock items are packed with 2-3/4" backset, Schlage C (SCC) keyway, and T strike square corner for wood frame construction. Knob and lever locksets are completely reversible for left or right hand doors.



Product No.	Mfg. No.	Description	Order Mult.	Weight	Unit Cost
243795-D	CL100002	Sv Passage Lockset	1/0/6	2.000	46.49 EA

Tell Mfg. Inc.

SV Series Privacy Lockset - Visual pack. For commercial and industrial interior privacy and bathroom doors. Push-button locking inside; knob with emergency opening outside. Inside knob or closing of door releases push-button. Satin stainless steel finish SV Series standard duty cylindrical knob and SK Series lever locksets for light commercial applications. UL listed for A label (3-hour) single swing door. Complies with ANSI A 156.2, Series 4000, Grade 2. Stock items are packed with 2-3/4" backset, Schlage C (SCC) keyway, and T strike square corner for wood frame construction. Knob and lever locksets are completely reversible for left or right hand doors.



Product No.	Mfg. No.	Description	Order Mult.	Weight	Unit Cost
243809-D	CL100004	Sv Privacy Lockset	1/0/6	2.150	52.99 EA

Tell Mfg. Inc.

SV Series Entry Lockset - Visual pack. For commercial and industrial exterior entry doors. Turn/push-button locking inside; keyed knob outside. Pushing button and turning knob locks outside knob requiring use of key until button is manually unlocked. Pushing button only locks outside knob until unlocked with key or inside knob is turned. Satin stainless steel finish. SV Series standard duty cylindrical knob and SK Series lever locksets for light commercial applications. UL listed for A label (3-hour) single swing door. Complies with ANSI A 156.2, Series 4000, Grade 2. Stock items are packed with 2-3/4" backset, Schlage C (SCC) keyway, and T strike square corner for wood frame construction. Knob and lever locksets are completely reversible for left or right hand doors.



Product No.	Mfg. No.	Description	Order Mult.	Weight	Unit Cost
243817-D	CL100008	Sv Entry Lockset	1/0/6	2.000	59.99 EA

Tell Mfg. Inc.

SK Series Passage Lever Lockset - Visual pack. Handicap accessibility for commercial and industrial interior doors where a simple latch is all that is required. Plain lever on both sides. Turning either lever will retract latchbolt at all times to open doors. Satin chromium-plated finish. Satin stainless steel finish. SV Series standard duty cylindrical knob and SK Series lever locksets for light commercial applications. UL listed for A label (3-hour) single swing door. Complies with ANSI A 156.2, Series 4000, Grade 2. Stock items are packed with 2-3/4" backset, Schlage C (SCC) keyway, and T strike square corner for wood frame construction. Knob and lever locksets are completely reversible for left or right hand doors. SK Series lever locksets for light commercial applications. UL listed for A label (3-hour) single swing door. Complies with ANSI A 156.2, Series 4000, Grade 2. Stock items are packed with 2-3/4" backset, Schlage C (SCC) keyway, and T strike square corner for wood frame construction. Lever locksets are completely reversible for left or right hand doors.



Product No.	Mfg. No.	Description	Order Mult.	Weight	Unit Cost
243825-D	CL00013	Sk Passage Leverset	1/0/6	5.000	79.99 EA

Tell Mfg. Inc.

SK Series Privacy Lever Lockset - Visual pack. Handicap accessibility for commercial and industrial interior privacy and bathroom doors. Push-button locking inside; lever with emergency opening outside. Inside lever or closing of door releases push-button. Satin chromium-plated finish. Satin stainless steel finish.



Product No.	Mfg. No.	Description	Order Mult.	Weight	Unit Cost
243833-D	CL00016	Sk Privacy Leverset	1/0/6	5.100	89.99 EA

LOCK SETS

HARDWARE

Tell Mfg. Inc.

SK Series Entry Lever Lockset - Visual pack. Handicap accessibility for commercial and industrial exterior entry doors. Turn/push-button locking inside; keyed lever outside. Pushing button and turning lever locks outside lever requiring use of key until button is manually unlocked. Pushing button only locks outside lever until unlocked with key or inside lever is turned. Satin chromium-plated finish. Satin stainless steel finish. UL listed for A label (3-hour) single swing door. Complies with ANSI A 156.2, Series 4000, Grade 2. Stock items are packed with 2-3/4" backset, Schlage C (SCC) keyway, and T strike square corner for wood frame construction. Knob and lever locksets are completely reversible for left or right hand doors.



Product No.	Mfg. No.	Description	Order Mult.	Weight	Unit Cost
243841-D	CL00011	Sk Entry Leverset	1/0/6	5.200	99.99 EA

Tell Mfg. Inc.

SV Series Entry Lockset - Box pack. For commercial and industrial exterior entry doors. Turn/push-button locking inside; keyed knob outside. Pushing button and turning knob locks outside knob requiring use of key until button is manually unlocked. Pushing button only locks outside knob until unlocked with key or inside knob is turned. Satin stainless steel finish. SV Series standard duty cylindrical knob and SK Series lever locksets for light commercial applications. UL listed for A label (3-hour) single swing door. Complies with ANSI A 156.2, Series 4000, Grade 2. Stock items are packed with 2-3/4" backset, Schlage C (SCC) keyway, and T strike square corner for wood frame construction. Knob and lever locksets are completely reversible for left or right hand doors.



Product No.	Mfg. No.	Description	Order Mult.	Weight	Unit Cost
212970-D	CL100034	Sv Entry Lockset	1/0/10	1.950	57.99 EA

Tell Mfg. Inc.

KV Series Deadbolt - Visual pack. Features mortise cylinders in a heavy-duty cylinder housing. 1" throw bolt with 2 hardened steel pins to prevent backsawing. The double cylinder deadbolt has no exposed screws with the 2 mortise cylinders held in place by cylinder set screws under the armored front. For door thicknesses 1-3/8" to 1-3/4". 2-3/4" backset. Solid stainless steel rose. Brass mortise 15/16" cylinder - 5 pin tumbler. Keyed different. Stainless steel finish. Schlage C keyway.



Product No.	Mfg. No.	Description	Order Mult.	Weight	Unit Cost
243868-D	CL00055	Single cylinder - lock or unlock by key from outside or thumb turn on inside	1/0/6	1.100	44.49 EA
243876-D	CL00056	Double cylinder - lock or unlock by key from both sides	1/0/6	1.300	48.49 EA

Tell Mfg. Inc.

Storeroom Knobset - Box pack. Satin stainless steel (32D) finish. Handicap accessibility. Inside is always free turning for immediate exit. Outside knob is always fixed and is unlocked by key. Complies with ANSI A 156.2, series 4000, and Grade 2. Stock items are packed with 2-3/4" backset.



Product No.	Mfg. No.	Description	Order Mult.	Weight	Unit Cost
214795-D	CL100006	32d Storeroom Knobset	1/0/6	2.167	59.99 EA

Tell Mfg. Inc.

SV Series Passage Lockset - Box pack. For commercial and industrial interior doors where a simple latch is all that is required. Plain knob on both sides. Turning either knob will retract latchbolt at all times to open door. Satin stainless steel finish. SV Series standard duty cylindrical knob and SK Series lever locksets for light commercial applications. UL listed for A label (3-hour) single swing door. Complies with ANSI A 156.2, Series 4000, Grade 2. Stock items are packed with 2-3/4" backset, Schlage C (SCC) keyway, and T strike square corner for wood frame construction. Knob and lever locksets are completely reversible for left or right hand doors.



Product No.	Mfg. No.	Description	Order Mult.	Weight	Unit Cost
212954-D	CL00020	Sv Passage Lockset	1/0/10	1.800	44.99 EA

Tell Mfg. Inc.

Storeroom Leverset - Box pack. Nonhanded satin chromium-plated (26D) finish. Handicap accessibility. Inside is always free turning for immediate exit. Outside lever is always fixed and is unlocked by key. Complies with ANSI A 156.2, series 4000, and Grade 2. Stock items are packed with 2-3/4" backset.



Product No.	Mfg. No.	Description	Order Mult.	Weight	Unit Cost
214805-D	CL1000010	26d Storeroom Leverset	1/0/6	4.833	104.99 EA

Tell Mfg. Inc.

Storeroom Or Vestibule Lockset - Box pack. For service doors or common entry exterior doors. Inside knob is always free turning for immediate exit. Outside knob is rigid, and is unlocked by key.



Tell Mfg. Inc.

SV Series Privacy Lockset - Box pack. For commercial and industrial interior privacy and bathroom doors. Push-button locking inside; knob with emergency opening outside. Inside knob or closing of door releases push-button. Satin stainless steel finish.

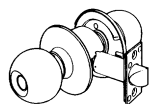

Product No.	Mfg. No.	Description	Order Mult.	Weight	Unit Cost
212946-D	CL00024	Sv Privacy Lockset	1/0/10	1.800	48.49 EA

Product No.	Mfg. No.	Description	Order Mult.	Weight	Unit Cost
212962-D	CL00045	Storeroom Lockset	1/0/10	1.950	62.99 EA

For your convenience, if an item is no longer available, we will gladly substitute a similar product!

HARDWARE

Tell Mfg. Inc.

SV Series Unguarded Springlatch - For SV Series passage or privacy knobsets and leversets. Square face latchbolt is 2-3/8" backset with satin stainless steel finish. SV Series standard duty cylindrical knob and SK Series lever locksets for light commercial applications. UL listed for A label (3-hour) single swing door. Complies with ANSI A 156.2, Series 4000, Grade 2. Stock items are packed with 2-3/4" backset, Schlage C (SCC) keyway, and T strike square corner for wood frame construction. Knob and lever locksets are completely reversible for left or right hand doors.



Product No.	Mfg. No.	Description	Order Mult.	Weight	Unit Cost
212865-D	CL100185	Sv Unguard Spring Latch	1/0/10	.250	12.79 EA

Tell Mfg. Inc.

SV Series Guarded Deadlatch - For SV Series entry or vestibule knobsets. Square face latchbolt with satin stainless steel finish. SV Series standard duty cylindrical knob and SK Series lever locksets for light commercial applications. UL listed for A label (3-hour) single swing door. Complies with ANSI A 156.2, Series 4000, Grade 2. Stock items are packed with 2-3/4" backset, Schlage C (SCC) keyway, and T strike square corner for wood frame construction. Knob and lever locksets are completely reversible for left or right hand doors. 2-3/4".



Product No.	Mfg. No.	Description	Order Mult.	Weight	Unit Cost
243884-D	CL100213	Sv Guarded Deadlatch	1/0/10	.400	13.49 EA

Tell Mfg. Inc.

SK Series Passage Lever Lockset - Box pack. Handicap accessibility for commercial and industrial interior doors where a simple latch is all that is required. Plain lever on both sides. Turning either lever will retract latchbolt at all times to open doors. Satin chromium- plated finish.

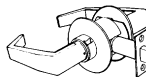

Product No.	Mfg. No.	Description	Order Mult.	Weight	Unit Cost
222232-D	CL00132	Sk Passage Leverset	1/0/6	2.400	79.99 EA

Tell Mfg. Inc.

SK Series Privacy Lever Lockset - Box pack. Handicap accessibility for commercial and industrial interior privacy and bathroom doors. Push-button locking inside; lever with emergency opening outside. Inside lever or closing of door releases push-button. Satin chromium- plated finish.

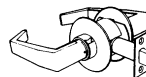

Product No.	Mfg. No.	Description	Order Mult.	Weight	Unit Cost
222224-D	CL00141	Sk Privacy Leverset	1/0/6	2.500	89.99 EA

Tell Mfg. Inc.

SK Series Entry Lever Lockset - Box pack. Handicap accessibility for commercial and industrial exterior entry doors. Turn/push-button locking inside; keyed lever outside. Pushing button and turning lever locks outside lever requiring use of key until button is manually unlocked. Pushing button only locks outside lever until unlocked with key or inside lever is turned. Satin chromium-plated finish. UL listed for A label (3-hour) single swing door. Complies with ANSI A 156.2, Series 4000, Grade 2. Stock items are packed with 2-3/4" backset, Schlage C (SCC) keyway, and T strike square corner for wood frame construction. Knob and lever locksets are completely reversible for left or right hand doors.



Product No.	Mfg. No.	Description	Order Mult.	Weight	Unit Cost
222216-D	CL00150	Sk Entry Leverset	1/0/6	2.500	97.99 EA

Tell Mfg. Inc.

SK Series Guarded Deadlatch - For SK series entry lever locksets. Square face deadlatch is 2-3/8" backset with satin stainless steel finish.

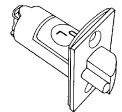

Product No.	Mfg. No.	Description	Order Mult.	Weight	Unit Cost
214108-D	CL100184	Sk Guarded Deadlatch	1/0/10	.200	12.49 EA

Tell Mfg. Inc.

KV Series Deadbolt - Box pack. Feature mortise cylinders in a heavy-duty cylinder housing. 1" throw bolt with 2 hardened steel pins to prevent backsawing. The double cylinder deadbolt has no exposed screws with the 2 mortise cylinders held in place by cylinder set screws under the armored front. For door thicknesses 1-3/8" to 1-3/4". 2-3/4" backset. Solid stainless steel rose. Brass mortise 15/16" cylinder - 5 pin tumbler. Keyed different. Stainless steel finish. Schlage C keyway. SV Series standard duty cylindrical knob and SK Series lever locksets for light commercial applications. UL listed for A label (3-hour) single swing door. Complies with ANSI A 156.2, Series 4000, Grade 2. Stock items are packed with 2-3/4" backset, Schlage C (SCC) keyway, and T strike square corner for wood frame construction. Knob and lever locksets are completely reversible for left or right hand doors.



Product No.	Mfg. No.	Description	Order Mult.	Weight	Unit Cost
212938-D	CL100180	Single cylinder - lock or unlock by key from outside or thumb turn on inside	1/0/10	1.625	41.49 EA
212911-D	CL100178	Double cylinder - lock or unlock by key from both sides	1/0/10	1.625	52.99 EA

Tell Mfg. Inc.

ASA Strike - For metal door frame. 1-1/4" x 4-7/8" x 3/32". Satin stainless finish.

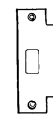

Product No.	Mfg. No.	Description	Order Mult.	Weight	Unit Cost
212849-D	CL100218	Asa Strike	1/0/10	.250	4.79 EA

DOOR REINFORCERS

HARDWARE

Tell Mfg. Inc.

Rim Cylinder - Brass cylinder 5 pin tumbler. For doors 1-1/4" to 2-1/4" thick. Available in US26D-satin chrome finishes. Furnished with screws and back plate. Schlage C keyway. Complies with ANSI A 156.2, Series 4000, Grade 2.

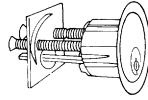

Product No.	Mfg. No.	Description	Order Mult.	Weight	Unit Cost
212881-D	CL100207 SCCKD RIM CYLIN	Rim Cylinder	1/0/10	.500	42.99 EA

Tell Mfg. Inc.

Mortise Cylinder - 1-1/4". 6 pin tumbler. Available in US26D-satin chrome finish. Keyed differently. Schlage C keyway. UL listed for A label (3-hour) single swing door. Complies with ANSI A 156.2, Series 4000, Grade 2.

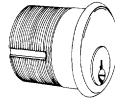

Product No.	Mfg. No.	Description	Order Mult.	Weight	Unit Cost
232564-D	CL100203 26D YALE CAM	1-1/4" Mortise Cylinder	1/0/10	.450	34.99 EA

Tell Mfg. Inc.

Rim Device - Commercial exit device. Nonhanded. Grade 1 UL listed. For 28" to 36" width doors. Aluminum finish. Exterior trim not furnished. Use exterior knob model No. EMP808 or lever model No. EX100005. This comes as an exit only device. The purchase of a trim package is required for exterior operation.



Product No.	Mfg. No.	Description	Order Mult.	Weight	Unit Cost
254460-D	8300B8PDTBE	Panic Rim Device	1/0/2	9.717	204.99 EA

Tell Mfg. Inc.

Knob Trim - Exterior knob to be used with rim device model No. 8300B8PDTBE. Key unlocks knob. Satin stainless steel finish. Keys included.



Product No.	Mfg. No.	Description	Order Mult.	Weight	Unit Cost
254479-D	EMP808	Ss Knob Trim	1/0/10	1.406	69.99 EA

IRWIN

Lock Installation Kit - Carbon steel hole saws for wood doors.

Includes: Self-centering jig for perfect hole alignment with mounting holes to secure jig and match the latch plate holes. 2-sided jig template includes 2-3/8" and 2-3/4" backsets. 1-3/8" depth of cut. Kit contains (1) 1" and 2-1/8" hole saw, on pilot drill, plastic self-centering jig, steel trim plate template, and brass router bit.



Product No.	Mfg. No.	Description	Order Mult.	Weight	Unit Cost
325375-B	3111001	Crbn Dr Lock Install Kit	1/0/6	.983	12.99 EA

IRWIN

Bi-metal Lock Installation Kit - Bi-metal hole saws for wood and steel doors. Includes: Self-centering jig for perfect hole alignment with mounting holes to secure jig and match the latch plate holes. 2-sided jig template includes 2-3/8" and 2-3/4" backsets. 1-3/8" depth of cut. Kit contains (1) 1" and 2-1/8" hole saw, on pilot drill, plastic self-centering jig, steel trim plate template, and brass router bit.



Product No.	Mfg. No.	Description	Order Mult.	Weight	Unit Cost
325348-B	3111002	Bi Metal Door Lock Kit	1/0/6	2.417	22.99 EA

MAG Security

Install-A-Lock® Door Reinforcer - High-security reinforcer surrounds door edge, face bore and accepts entry lockset. Door reinforcer adds security at all entry doors of home. Prevent kick-ins, repair damaged or misdrilled doors, saves costly door replacements. For 2-1/8" face bore with either drive-in or mortise face latch bolt.



Product No.	Mfg. No.	Description	Order Mult.	Weight	Unit Cost
206466-D	2001PBV	1-3/8 2-3/8 Reinforcer	1/4/32	.863	22.99 EA
206474-D	2002PBV	1-3/4 2-3/8 Reinforcer	1/4/32	.863	22.99 EA
203378-D	2003PBV	1-3/8 2-3/4 Reinforcer	1/0/4	.975	22.99 EA
205001-D	2004PBV	1-3/4 2-3/4 Reinforcer	1/0/4	.975	22.99 EA

MAG Security

Install-A-Lock® Door Reinforcer - Contemporary high-security reinforcer surrounds door edge, face bore, and accepts single-cylinder or double-cylinder deadbolt. Door reinforcer adds security at all entry doors of home. Prevent kick-ins, repair damaged or misdrilled doors, saves costly door replacement. For 2-1/8" face bore with either drive-in or mortise face latch bolt.



Product No.	Mfg. No.	Description	Order Mult.	Weight	Unit Cost
247057-D	2035PBV	1-3/8 2-3/8 Reinforcer	1/0/4	.288	11.49 EA
247065-D	2036PBV	1-3/4 2-3/8 Reinforcer	1/0/4	.300	11.49 EA
247073-D	2038PBV	1-3/4 2-3/4 Reinforcer	1/0/4	.338	11.49 EA

HARDWARE

HARDWARE

DOOR REINFORCERS



Install-A-Lock® Door Reinforcer - High-security reinforcer surrounds door edge, face bore and accepts single-cylinder or double-cylinder deadbolt. Door reinforcer adds security at all entry doors of home. Prevent kick-ins, repair damaged or misdrilled doors, saves costly door replacement. For 2-1/8" face bore with either drive-in or mortise face latch bolt.



Product No.	Mfg. No.	Description	Order Mult.	Weight	Unit Cost
206512-D	2061PBV	1-3/4 2-3/8 Reinforcer	1/0/4	.486	14.79 EA
206504-D	2051PBV	1-3/8 2-3/8 Reinforcer	1/0/4	.450	13.99 EA
203408-D	2081PBV	1-3/4 2-3/4 Reinforcer	1/0/4	.488	13.99 EA



Install-A-Lock® Door Reinforcer - High-security reinforcer surrounds door edge, face bore, and accepts entry lockset plus single-cylinder or double-cylinder deadbolt. Door reinforcer adds security at all entry doors of home. Prevent kick-ins, repair damaged or misdrilled doors, saves costly door replacement. For 2-1/8" face bores 3-5/8" on center with either drive-in or mortise face latch bolts.



Product No.	Mfg. No.	Description	Order Mult.	Weight	Unit Cost
214922-D	2261PBV	1-3/4 2-3/8 Reinforcer	1/0/4	.975	25.49 EA



Uni-Force Door Reinforcement - Reinforces deadbolt and key-in-knob locks by more than doubling strength of door at critical stress points. Heavy-gauge metal, solid 1-piece construction guards against kick-in attacks. Deadbolt not included. Polished brass.



Product No.	Mfg. No.	Description	Order Mult.	Weight	Unit Cost
206520-D	10PB	For doors 1-3/8" thick	1/0/4	.250	8.29 EA
206539-D	20PB	For doors 1-3/4" thick	1/0/4	.263	8.29 EA



Guard-It™ Reinforcing Kit - Security reinforcer surrounds door edge protecting deadbolt and door. High-security strike accepts deadbolt latch and reinforces door frame. Guard-it™ reinforcing kit adds security at all entry doors of home. Prevent kick-ins, saves costly door replacement. For drive-in or mortise face latch bolt. For 1-3/8" or 1-3/4" thick doors in polished brass (PB).

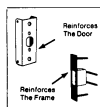

Product No.	Mfg. No.	Description	Order Mult.	Weight	Unit Cost
214809-D	220PB	1-3/4" Reinforcer Kit	1/0/4	.588	16.49 EA



Strike-3 Deadbolt And Door Frame Reinforcer - Secured by four 2" long hardened screws. Strike box prevents lock bolts from being pushed in with a punch on out-opening doors. 2 mounting screws position at bottom of box are offset and angled to center of jamb making solid connection between strike and door frame stud. Constructed of heavy 16-gauge steel. Box dimensions: 1-5/8 H. x 3/4" W. x 1-1/4" D. Face plate dimensions: 4-7/8" H. x 1-1/4" W. Fits ASA cutout. Brass finish.



Product No.	Mfg. No.	Description	Order Mult.	Weight	Unit Cost
206563-D	747B	Brs Security Strike	1/0/5	.380	13.49 EA



Adjust-A-Strike - For interior and exterior door frames. Unique 1/4" of adjustment allows for snug fit of door to frame and weatherstrip. Stops energy loss, door rattles and lock binding. Brass finish.



Product No.	Mfg. No.	Description	Order Mult.	Weight	Unit Cost
206555-D	450B	2-3/4" x 1-1/4"	1/0/5	.006	7.29 EA
214957-D	452B	4-7/8" x 1-1/4"	1/0/5	.180	8.29 EA



Lip Strike - Overall dimensions 1-3/4" x 2-1/4". Packaged 2 per card.



Product No.	Mfg. No.	Description	Order Mult.	Weight	Unit Cost
247081-E	718-B	Brass	1/0/5	.170	2.79 EA
247103-E	718-C	Chrome	1/0/5	.170	2.79 EA



Lip Strike - Polished brass. Overall dimensions: 1-1/4" x 4-7/8".



Product No.	Mfg. No.	Description	Order Mult.	Weight	Unit Cost
214965-D	721B	1-1/4" Pb Lip Strike	1/5/50	.190	5.49 EA

SECURITY STRIKES

HARDWARE



Security Strike - Security strike for deadbolts. Overall dimensions 1-1/4" x 3-5/8" with 2 each No. 10 1-1/4" and 3" screws. Brass. 1 per card.



Product No.	Mfg. No.	Description	Order Mult.	Weight	Unit Cost
247111-E	750-B	Brs Security Strike	1/0/5	.170	2.29 EA



Security Strike - Security strike for deadbolts. Overall dimensions: 1-1/4" x 4-7/8" with 2 each No. 10 1-1/4" and 3" screws. Brass. 1 per card.



Product No.	Mfg. No.	Description	Order Mult.	Weight	Unit Cost
247138-D	755-B	Brs Security Strike	1/0/5	.170	5.79 EA



Security Strike - Heavy-gauge deadbolt strike with six 1-1/2" long hardened screws. Secures door frame against kick-in attacks. Overall dimensions: 1-1/8" to 6". Fits any door thickness. Polished brass.



Product No.	Mfg. No.	Description	Order Mult.	Weight	Unit Cost
201464-D	760B	Pb Security Strike	1/0/5	.230	7.99 EA



Deadbolt Security Strike - Heavy-gauge strike is attached with six 3" long hardened screws. Secures door frame against kick-in attacks. Overall dimensions: 1-5/8" x 7-3/4". For 1-3/4" thick doors. Polished brass.



Product No.	Mfg. No.	Description	Order Mult.	Weight	Unit Cost
239666-D	765B	Pb Security Strike	1/0/5	.360	5.29 EA



Lip Security Strike - Heavy-gauge strike is attached with six 3" long hardened screws. Secures door frame against kick-in attacks. Overall dimensions: 1-1/4" x 8". For 1-3/8" or 1-3/4" doors. Polished brass.



Product No.	Mfg. No.	Description	Order Mult.	Weight	Unit Cost
239674-D	770B	Pb Lip Security Strike	1/0/5	.350	5.99 EA



Security Strike - Heavy-gauge double strike is attached with nine 3" long hardened screws (3-5/8" or 4" centers). Secures door frame against kick-in attacks. Overall dimensions: 1-5/8" x 11". For 1-3/4" door thickness. Polished brass.



Product No.	Mfg. No.	Description	Order Mult.	Weight	Unit Cost
201456-D	775B	Pb Dbl Security Strike	1/0/5	.600	14.49 EA



Chain Door Guard - Help prevent break-ins doubling the strength of any door and lockset. Easy-to-install. For wood or metal doors. All mounting hardware included. White. 1 per card.



Product No.	Mfg. No.	Description	Order Mult.	Weight	Unit Cost
247146-E	8707-W	Wht Chain Door Lock	1/0/5	.284	2.79 EA



Tamperproof Chain Door Guard - Hook-up keeps chain tight to prevent break-ins. Easy-to-install. For wood and metal doors. All mounting hardware included. Brass. 1 per card.



Product No.	Mfg. No.	Description	Order Mult.	Weight	Unit Cost
247154-D	8709	Brs Chain Door Guard	1/0/5	.370	3.99 EA

HARDWARE

DOOR/WINDOW SECURITY



Door Guard - Latching door guard provides extra security from within. Throwing latch guard in place allows only partial door opening. For wood and metal doors. All mounting hardware included. White. 1 per card.



Product No.	Mfg. No.	Description	Order Mult.	Weight	Unit Cost
247162-D	8715-W	Wht Door Guard	1/0/5	.470	6.79 EA



Door Viewer, Wide Angle - Solid brass with optical glass lens. Fits 1-3/8" to 2" doors. 190° viewer. Hole size 1/2". 1 per card.



Product No.	Mfg. No.	Description	Order Mult.	Weight	Unit Cost
247219-D	8724	1/2" Wide Door Viewer	1/0/5	.110	4.99 EA



Door Viewer - Solid brass with optical glass lens. Fits 1-3/8" to 2" doors. Super viewer, 180°. Hole size 1". 1 per card.



Product No.	Mfg. No.	Description	Order Mult.	Weight	Unit Cost
247170-D	8728	1" Door Viewer	1/0/5	.180	13.99 EA



Heavy-Duty Sliding Window Lock - For door or window, fits upper or lower track vent feature for fresh air with security. Pointed screw for added security. 2 per card.



Product No.	Mfg. No.	Description	Order Mult.	Weight	Unit Cost
247197-D	8732	Aluminum	1/0/5	.120	2.29 EA
247189-E	8732-W	White	1/0/5	.120	2.79 EA



Sliding Window Lock - With rubber insert. Aluminum finish. 2 per card.



Product No.	Mfg. No.	Description	Order Mult.	Weight	Unit Cost
247251-D	8743	Alum Sliding Window Lock	1/0/5	1.080	1.79 EA



Sliding Door Bar Lock - Heavy-gauge steel, maximum security. Locks in vented or closed position. Adjusts to fit 28" to 48" doors. Mounts on inside or outside sliders. Lock prevents lifting bar from outside. Easy installation. Easily stored when not in use. Color: Aluminum.



Product No.	Mfg. No.	Description	Order Mult.	Weight	Unit Cost
247367-D	8820	Sliding Door Bar Lock	1/0/5	1.720	18.99 EA



Latch Guard 6" - For deadbolts or key in knob locks. For in or out-opening doors. Overall size: 1-3/4" x 6".



Product No.	Mfg. No.	Description	Order Mult.	Weight	Unit Cost
247375-D	8844-AL	Aluminum	1/0/5	.200	10.49 EA
247383-D	8844-B	Brass	1/0/5	.200	8.99 EA



7" Latch Guard - Reinforces door and frame. Prevents spreading of frame. Resists jimmy bars. Hardened concealed screws. For in-opening doors. Fits all backsets, deadbolts, and key-in knob locks. Polished brass.



Product No.	Mfg. No.	Description	Order Mult.	Weight	Unit Cost
239607-D	8840B	7" Pb Latch Guard	1/0/5	.570	12.79 EA

DOOR/WINDOW SECURITY

HARDWARE



6" Latch Guard - Protects latch or bolt. For out-opening doors. Fits all backsets, deadbolts, and key-in knob locks. Accepts up to 3-1/2" rose. Polished brass.



Product No.	Mfg. No.	Description	Order Mult.	Weight	Unit Cost
239615-D	8845B	6" Pb Latch Guard	1/0/5	.560	10.49 EA



Cover Plate - Covers damaged doors. Changes 2-3/8" to 2-3/4" or 2-3/4" to 2-3/8" backset. 3-1/2" outside diameter. For 2-1/8" bore locks. Polished brass.



Product No.	Mfg. No.	Description	Order Mult.	Weight	Unit Cost
239690-D	8865B	Pb Cover Plate	1/0/5	.210	4.49 EA



7" Latch Guard - Protects latch or bolt, conceals lip of existing strike. For out-opening doors, fits all backsets, deadbolts, and key-in knob locks. Accepts up to 3-1/2" rose. Polished brass.



Product No.	Mfg. No.	Description	Order Mult.	Weight	Unit Cost
201480-D	8848B	7" Pb Latch Guard	1/0/5	.750	11.49 EA



Hole Cover - Covers 1/2" to 2-1/8" holes. 2-5/8" outside diameter. Self-centering disc prevents movement of plate.



Product No.	Mfg. No.	Description	Order Mult.	Weight	Unit Cost
239704-D	8868B	Brass	1/0/5	.280	6.99 EA
247391-D	8868-PC	Prime coat	1/0/5	.280	5.49 EA



11-3/4" Latch Guard - Protects latch or bolt. For out-opening doors. Fits all single locks, double locks up to 6" on center, combination locks, mortise locks, and access control locks. Conceals lip of existing strike. Reinforced mounting area. Anti-spread security pin. Polished brass.



Product No.	Mfg. No.	Description	Order Mult.	Weight	Unit Cost
239631-D	8850B	11-3/4" Pb Latch Guard	1/0/5	1.210	15.49 EA



Lock Protector - Covers the latch bolt area of door and lock assembly. Ideal for use with mortise or cylindrical lock. Heavy-duty 12-gauge steel. Frame pin to help prevent the separation of the door and frame by the use of a pry bar. Nonhanded. Easy 3-hole installation. Steel cadmium-plate. US2C.

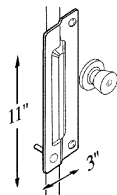

Product No.	Mfg. No.	Description	Order Mult.	Weight	Unit Cost
212695-D	8847-AL/LP2	Lock Protector	1/5/40	1.053	9.79 EA



Keyed Patio Door Lock - High security 2" deadbolt for maximum security. Locks sliding patio or hinged doors. For use on inside or outside sliding patio doors. 1 per card. 2 keys included. Aluminum.



Product No.	Mfg. No.	Description	Order Mult.	Weight	Unit Cost
248266-C	8825-AL	Keyed Patio Door Lock	1/5/40	.875	17.79 CD

National Mfg.

Sash Lock - Zinc die-cast. 2-7/16" x 1-11/16" x 7/8" base. Packed 1 per bag in a visual pack with screws.



Product No.	Mfg. No.	Description	Order Mult.	Weight	Unit Cost
217429-D	N148684	Bright brass	1/5/25	.150	1.99 PK
217447-C	N148767	Nickel	1/5/35	.138	1.99 PK
235864-C	N148809	Antique brass	1/5/35	.137	1.99 PK
256919-C	N248468	White	1/5/35	.150	2.49 PK

HARDWARE

HARDWARE

DOOR/WINDOW SECURITY

National Mfg.

Sash Lock - Contemporary style that fits narrow window sills in die-cast zinc. Bright brass and antique brass finishes available.



Product No.	Mfg. No.	Description	Order Mult.	Weight	Unit Cost
221405-C	N170779	Bright Brs Sash Lock	1/5/25	.172	2.29 PK
220004-C	N170761	Ab Sash Lock	1/5/35	.158	2.49 PK

National Mfg.

Door Viewer - 1-way viewing even under dim lights. 3 precision ground optical glass lenses. Solid brass housing. Packed in visual pack. Lens angle: 160°. Hole size: 1/2". Door thickness: 1-3/8" to 2".



Product No.	Mfg. No.	Description	Order Mult.	Weight	Unit Cost
234115-C	N158907	Solid Brass Door Viewer	1/5/25	.070	3.99 PK

National Mfg.

Door Viewer - Allows 1-way viewing. 4 precision ground optical glass lenses. Solid brass housing. Lens angle 200°. Hole size: 1/2". Door thickness: 1-3/8" to 2".



Product No.	Mfg. No.	Description	Order Mult.	Weight	Unit Cost
241261-C	N162362	Solid Brass Door Viewer	1/5/25	.094	5.79 EA

National Mfg.

Keyed Chain Door Lock - Triple-function protection with keylock, chain guard and door bolt. Can be locked or unlocked from outside as well as inside. Tamper-resistant screws. 5-disc tumbler lock. Bright brass finish.



Product No.	Mfg. No.	Description	Order Mult.	Weight	Unit Cost
213470-C	N183582	Keyed Chain Door Lock	1/5/20	.672	5.29 PK

National Mfg.

Steel Chain Door Fastener - Economical protection with welded steel self-storing chain and extra long tamper-resistant mounting screws. Easy-to-install. All mounting hardware included. Bright brass finish.



Product No.	Mfg. No.	Description	Order Mult.	Weight	Unit Cost
213462-D	N183590	Stl Chain Door Fastener	1/5/25	.294	1.79 PK

National Mfg.

Door Stop With Lock - For use on swinging or sliding doors. Operates with a touch of the foot. Solid aluminum housing with steel bolt and stop plate. Bright brass finish.



Product No.	Mfg. No.	Description	Order Mult.	Weight	Unit Cost
213411-C	N183632	Brs Door Stop/lock	1/5/25	.276	5.79 PK

National Mfg.

Patio Door Security Pin - For all sliding doors and windows. Hardened steel pin securely holds door in stationary position. A turn of the pin locks it in retainer ring to prevent falling out or removal from outside. Nickel finish.



Product No.	Mfg. No.	Description	Order Mult.	Weight	Unit Cost
213403-D	N183640	Patio Door Security Pin	1/10/50	.102	1.29 PK

National Mfg.

Patio Door And Window Lock - Locks on window or door track in closed or any ventilating position. No tool required. Aluminum finish.



Product No.	Mfg. No.	Description	Order Mult.	Weight	Unit Cost
213357-C	N183681	1-3/4" Patio Lock	1/5/25	.124	1.49 PK

National Mfg.

Sliding Door And Window Movable Stop - Locks patio doors and vertical or horizontal aluminum sliding windows. Simple thumb screw operation. No tools required. Aluminum. 2 per card.

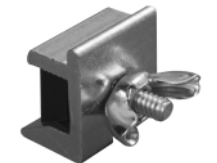

Product No.	Mfg. No.	Description	Order Mult.	Weight	Unit Cost
213349-D	N183699	Sliding Door/window Stop	1/5/50	.093	2.79 PK

National Mfg.

Chain Bolt - Steel case and strike die-cast zinc bolt. Malleable iron 5/8" square reversible bolt. Overall length: 6". 21" chain. Supplied with screws, bolt rim and mortise strikes. Visual packed. Zinc.



Product No.	Mfg. No.	Description	Order Mult.	Weight	Unit Cost
223485-C	N150771	6" Zn Chain Bolt	1/2/18	.850	11.79 PK

DOOR/WINDOW SECURITY

HARDWARE

National Mfg.

Keyed Window Sash Lock - For all wood double-hung windows. Prevents opening of window, even if glass is broken. Heavy die-cast body with keyed lock. Complete with 2 keys and mounting screws. Bright brass-plated.



Product No.	Mfg. No.	Description	Order Mult.	Weight	Unit Cost
213322-C	N183723	Brs Keyed Sash Lock	1/5/25	.336	3.49 PK

National Mfg.

Door And Drawer Utility Lock - Ideal for securing wood or metal doors or drawers. Includes 2 keys. Chrome-plated.



Product No.	Mfg. No.	Description	Order Mult.	Weight	Unit Cost
213284-C	N183756	1/4", for material thickness up to 3/8"	1/5/25	.211	2.99 PK
213276-C	N183764	1/2", for material thickness up to 5/8"	1/5/25	.219	2.99 PK

National Mfg.

Keyed Drawer Lock - Fits 3/4" thick drawers or cabinet doors. Secure 5-disc tumbler key mechanism. Includes 2 keys. Bright brass-plated.



Product No.	Mfg. No.	Description	Order Mult.	Weight	Unit Cost
213268-C	N183772	Brs Keyed Drawer Lock	1/5/50	.233	2.49 PK

National Mfg.

Keyed Locking Hasp - For indoor or outdoor use. Self-contained lock eliminates need for padlock. All screws covered when locked. Heavy steel construction. Includes 2 keys and mounting hardware. Chrome-plated. 4-1/2".



Product No.	Mfg. No.	Description	Order Mult.	Weight	Unit Cost
213241-C	N183780	V827 keyed different	1/5/25	.557	5.29 PK
206280-D	N206953	VKA827 keyed alike	1/5/25	.568	5.99 PK

National Mfg.

Keyed Showcase Lock - For display cases, showcase windows. Ideal for all sliding glass, wood, or metal doors up to 1/4" thick. Includes 2 keys. Chrome-plated.



Product No.	Mfg. No.	Description	Order Mult.	Weight	Unit Cost
213233-C	N183798	V828 keyed different	1/5/25	.249	3.29 PK
206299-D	N185306	VKA82 keyed alike 4-1/2"	1/5/20	.276	3.49 PK

National Mfg.

Foot Bolt - Size 5" x 2" steel case, 5/8" square die-cast bolt. Bolt length 6" overall. The lever to raise bolt has positive action. Bolt is held in place when raised by an oil-tempered steel friction spring. Complete with floor plate and screws. Packed in visual pack. Zinc.



Product No.	Mfg. No.	Description	Order Mult.	Weight	Unit Cost
223421-C	N151027	5" Zn Foot Bolt	1/2/18	.825	10.49 PK

National Mfg.

Barrel Bolt - Cold rolled steel. Packed in visual pack with oval head screws. Heavy-duty.



Product No.	Mfg. No.	Description	Order Mult.	Weight	Unit Cost
235819-C	N162370	4"	1/5/50	.444	4.99 PK
217081-C	N162388	6"	1/5/50	.581	5.99 PK

National Mfg.

Heavy Barrel Bolt - For use on rear store doors, stock rooms, farm buildings, and heavy-duty installations where additional security is desired. Recess in slot holds knob of sliding bolt in locked position when used vertically or horizontally. Furnished with both surface and universal strikes. Zinc finish. Visual pack with screws.

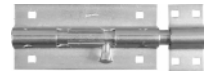

Product No.	Mfg. No.	Description	Order Mult.	Weight	Unit Cost
207127-C	N151167	8"	1/2/18	1.563	10.79 PK
222949-C	N151118	5"	1/2/18	1.217	9.79 PK

National Mfg.

Window Bolt - Cellar window bolt. Cold rolled steel. Packed in visual pack with pan head screws. 2".

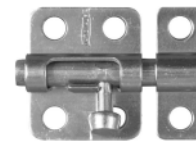

Product No.	Mfg. No.	Description	Order Mult.	Weight	Unit Cost
217027-C	N151266	Satin brass finish	1/10/100	.142	1.79 PK
229274-C	N151225	Zinc finish	1/10/100	.142	1.79 PK
206182-D	N248492	White finish	1/5/50	.153	2.49 PK

National Mfg.

Door Security Guard - Die-cast zinc. Allows door to be opened slightly for ventilation or viewing while resisting possible forced entry. Size: 2-1/2" x 4-1/8". Bright brass finish. Packed 1 each in a visual pack with screws.

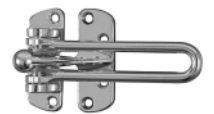

Product No.	Mfg. No.	Description	Order Mult.	Weight	Unit Cost
242462-C	N199679	Security Guard	1/5/20	.450	3.99 PK

Yale Security

Security Latchlock - Single-cylinder. Key outside, thumb turn inside. For 1-1/8" to 2-1/4" thick doors opening in. Latchbolt: 17/32" throw, high-density rust-resistant alloy, brass finish. Latchbolt held retracted and deadlocked by button. Case 3-5/8" x 2-1/2". US5 finish. Backset: 2-3/8".



Product No.	Mfg. No.	Description	Order Mult.	Weight	Unit Cost
205192-D	V80	Security Latchlock	1/0/5	1.531	37.99 EA

Master Lock

Universal Security Bar - For hinged doors or 5' and 6' glass doors. Rugged 20-gauge steel construction. Pivoting ball joint assures full contact with floor. Padded foot provides sure grip without scratching. Lifetime guarantee. Finish is white baked enamel.



Product No.	Mfg. No.	Description	Order Mult.	Weight	Unit Cost
221031-C	265DCCSEN	Security Bar	1/0/3	2.533	21.49 EA

Sterling Corp., John

Burglar Bars - Protect basement, garage, and house windows from break in's. Hinged burglar bars are constructed of 3/8" solid steel bars and heavy-duty welded channels. Finish is white enamel. Burglar bars are adjustable width of 24" to 42", and can be surface or recess mounted. Most models accept padlock (not included). Model No. 1132 does not accept padlock. Mounting hardware included. Child safety 3-1/2" spacing between bars.

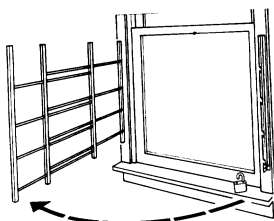

Product No.	Mfg. No.	Description	Order Mult.	Weight	Unit Cost
205806-D	1132	2 bar, 4-7/8" crossbar height, 6-9/16" overall height	0/0/2	5.000	17.99 EA
205726-D	1133	3 bar, 8-11/16" crossbar height, 10-3/8" overall height	0/0/2	8.000	23.99 EA
205717-D	1134	4 bar, 12-1/2" crossbar height, 14-3/16" overall height	0/0/2	11.000	31.99 EA
205879-D	1135	5 bar, 16-5/16" crossbar height, 18" overall height	0/0/2	13.500	37.99 EA
206002-D	1136	6 bar, 20-1/8" crossbar height, 21-13/16" overall height	0/0/2	17.000	44.99 EA



Mailbox Lock - Spring clip design. Replaces Bommer, Florence, Cutler, American Device, and Miami Carey. 5-pin tumbler. Key removes only in locked position. Packed with 2 keys, jam nut, and 3 cams. Keyway is Ilco model No. 1003M.



Product No.	Mfg. No.	Description	Order Mult.	Weight	Unit Cost
243310-D	8803	Mailbox Lock	1/0/5	.150	5.99 EA



Mailbox Lock - Threaded barrel design. Replaces Bommer, Florence, Cutler, American Device, and Miami Carey. 5-pin tumbler. Key removes only in locked position. Packed with 2 keys, jam nut, large nut, and 3 cams. Keyway is Ilco model No. 1003M.



Product No.	Mfg. No.	Description	Order Mult.	Weight	Unit Cost
243329-D	8800	Mailbox Lock	1/0/5	.150	5.79 EA

Supra Products Inc.

Keysafe - Portable keysafe key boxes are convenient locking storage devices that ensures your family knows where your keys are. Hangs on any doorknob, fence, railing, or pipe. Key box opens quickly with a simple combination you choose and set yourself with a screwdriver. Multiple keys can be stored inside. 1 can be attached to the box lid so it will not be dropped, carried off, or lost. Key boxes are rustproof, durable, and warranted against defects in materials, and workmanship for 1 year. Hanging shackle has protective cover so it will not scratch.



Product No.	Mfg. No.	Description	Order Mult.	Weight	Unit Cost
217530-C	01000	Portable Keysafe	1/0/12	1.550	35.49 EA

Supra Products Inc.

Keysafe - Permanent keysafe key boxes are convenient locking storage devices that ensures your family knows where your keys are. Key box attaches securely to any wall or flat surface with 4 screws (provided). Key box opens quickly with a simple combination you choose and set yourself with a screwdriver. Multiple keys can be stored inside. 1 key can be attached to the lid so it will not be dropped, carried off, or lost. Key boxes are rustproof, durable, and warranted against defects in materials and workmanship for 1 year.



Product No.	Mfg. No.	Description	Order Mult.	Weight	Unit Cost
217549-C	001004	Push-button Keysafe	1/0/6	1.450	35.49 EA

Supra Products Inc.

Keysafe - Keysafe combination-lock key boxes are convenient locking storage devices that make sure you know where your keys are. Hangs on any doorknob, fence, railing, or pipe. Key boxes open quickly with a simple combination you choose and set yourself. Multiple keys can be stored inside. 1 key can be attached to the box lid so it will not be dropped, carried off, or lost. Key boxes are rustproof, durable, and warranted against defects in materials, and workmanship for 1 year. Hanging shackle has protective cover so it will not scratch.



Product No.	Mfg. No.	Description	Order Mult.	Weight	Unit Cost
217557-C	001005	Combination Keysafe	1/0/12	1.583	35.49 EA

Master Lock

Padlock - 2-1/2" wide laminated steel case. Precision 5-pin tumbler mechanism. Dual steel levers independently lock each shackle leg, adding strength and guarding against shimmying or rapping. Resilient bumper keeps padlock from marring or scratching. Erasable key change numbers can be removed for added security. Case-hardened alloy steel shackle, chrome-plated. Diameter: 7/16". Clearances: Vertical 1", horizontal 1-3/16". Paracentric keyway, exclusive to No. 15 padlock only. Changes practically unlimited. Cadmium rustproofing. 2 brass keys. Keyed differently. 1 per card, 6 in a carton.



Product No.	Mfg. No.	Description	Order Mult.	Weight	Unit Cost
213478-D	15DPF	2-1/2" Padlock	1/6/24	1.552	24.49 EA

Master Lock

Padlock - 2" wide laminated steel case. 5-pin tumbler mechanism. Dual steel levers lock 7/16" shackle leg. Clearances: Vertical 1", horizontal 3/4". Case-hardened alloy steel shackle, 7/16" diameter. Cadmium rustproof. Keyed differently. 2 brass keys. Carded.



Product No.	Mfg. No.	Description	Order Mult.	Weight	Unit Cost
213067-D	17DPF	2" Padlock	1/6/24	.958	18.49 EA

Master Lock

Padlock - 1-1/8" wide. 4-pin tumbler security. Tough, laminated, cadmium rustproofed steel case, nickel-plated shackle, 3/16" diameter. Shackle clearance: Vertical 9/16" horizontal 1/2". Removable key-change number for added security. Patented guard plates to resist attempts at rapping and picking to open locking lever. 2 brass keys. Numbers following KA in pricing designates key number. All items ordered from that SKU number would be keyed alike to that number.



Product No.	Mfg. No.	Description	Order Mult.	Weight	Unit Cost
225321-D	7KA Series	Keyed alike, boxed	1/6/24	.222	8.79 EA
225349-D	7D	Keyed different, 1 per card	1/6/24	.222	7.99 EA
225330-D	7KA	1-1/8" P323 Padlock	1/6/12	.222	8.79 EA
214538-D	7D	1-1/8" Padlock	1/4/24	.241	6.99 EA

Master Lock

Commercial Padlock - 1-1/2" wide laminated case. 4-pin tumbler security. Dual steel levers lock both sides of case-hardened, 9/32" diameter steel shackle. Clearances: 3/4" vertical, 5/8" horizontal. 2 brass keys. Numbers following KA in pricing designates key number. All items ordered from that SKU number would be keyed alike to that number.



Product No.	Mfg. No.	Description	Order Mult.	Weight	Unit Cost
214574-D	3	Keyed different, boxed	1/6/24	.444	7.99 EA
220310-D	3KALF 3753	1-1/2" shackle, keyed alike, boxed	1/6/24	.472	12.49 EA

Master Lock

Padlock - 1-1/2" wide laminated case. 4-pin tumbler security. Dual steel levers lock both sides of case-hardened, 9/32" diameter steel shackle. Clearances: 3/4" vertical, 5/8" horizontal. 2 brass keys. Numbers following KA in pricing designates key number. All items ordered from that SKU number would be keyed alike to that number.



Product No.	Mfg. No.	Description	Order Mult.	Weight	Unit Cost
222048-D	3KA Series	Keyed alike, boxed	1/6/24	.444	8.79 EA
221771-D	3DLH	Extra-length shackle, vertical clearance 2"	1/6/24	.444	8.79 EA
221799-D	3DLF	Extra-length shackle, vertical clearance 1-1/2"	1/6/24	.444	8.79 EA
226173-D	3D	Keyed different	1/6/24	.444	8.79 EA
226181-D	3T	Twin pack - 2 keyed alike on card	1/6/24	.444	10.49 EA
221806-D	3008D	4 pack - 4 keyed alike	1/6/24	.444	8.79 EA
205680-D	3DLH	2" Padlock	1/6/36	.500	11.99 EA
213539-D	3DLF	1-1/2" Padlock	1/4/24	.472	10.79 EA
214529-D	3D	1-1/2" Padlock	1/4/24	.731	8.79 EA
213664-D	3T	2pk 1-1/2" Padlock	1/4/16	.889	16.49 EA
202622-D	3008D	4pk 1-1/2" Padlock	1/4/16	1.750	24.99 EA

Master Lock

Universal Pin Padlock - For use with Master Lock's universal pin keying system. 1/2" wide laminated case 4-pin tumbler security. Dual steel levers lock both sides of case-hardened 9/32" diameter steel shackle. 5/8" horizontal clearance.



Product No.	Mfg. No.	Description	Order Mult.	Weight	Unit Cost
243981-D	3UP	Vertical clearance 3/4"	1/6/24	.444	8.29 EA
243973-D	3UPLF	Extra length shackle, vertical clearance 1-1/2"	1/6/24	.472	10.99 EA

NOTE: Universal pin padlocks are for use with Master Lock's universal pin keying system. The system utilizes a mounted fixture to shear the serrated pins to fit a customer's existing padlock key. Padlocks do not include keys. The fixture must be purchased drop shipment from Master Lock.

Master Lock

Padlock With Weather Cover - 1-1/2" wide laminated steel body with outdoor protection cover. Case hardened 9/32" steel shackle protects against cutting and sawing. Hi-tech thermoplastic cover withstands temperature extremes and sunlight without becoming brittle or cracked. Cover protects the lock body and prevents scratching and marring of surrounding surfaces. Quick snap cap minimizes key cylinder jams caused by dust, dirt, and freezing.



Product No.	Mfg. No.	Description	Order Mult.	Weight	Unit Cost
236721-D	312D	Single pack, keyed different, blue cover	1/4/24	.518	11.49 EA
201324-D	312TRI	3 pack, keyed alike, blue cover	1/4/16	1.523	24.99 EA

Master Lock

Weather Proof Padlock - 1-1/2" (38mm) wide laminated steel body encased in a high-performance thermoplastic cover. 4-pin tumbler cylinder and dual locking steel levers for pick and pry resistance. Shackle is case hardened measuring 2" (51mm) long with a 9/32" (7mm) diameter (3/8" (10mm) diameter including cover). Insert molded shackle cover provides protection against the elements. Shackle clearances: Vertical 2" (51mm); horizontal 1/2" (13mm). Keys are nickel-plated brass and feature colored covers that match body colors. 2 keys provided per lock.



Product No.	Mfg. No.	Description	Order Mult.	Weight	Unit Cost
213584-D	312DLH	1-9/16" Weathprf Padlock	1/4/24	.767	13.99 EA

Master Lock

Camouflaged Padlock - 1-1/2" wide laminated steel body. 4-pin tumbler. Weatherproof outdoor security for outdoor applications. Maximum concealment. Materials, covers, and coatings are all formulated for weather, road grime, dust, and ice resistance. Camouflaged cover is equally at home in spring and fall environments. Shackle is of hardened steel for maximum cut resistance. Shackle coating will not scratch or mar surfaces while eliminating noise and light reflection. Covered keyway prevents freeze-up. Dimensions: 3/8" diameter steel shackle, 1" vertical, 1/2" horizontal clearance. Color: Lock body is camouflage green and shackle is black.



Product No.	Mfg. No.	Description	Order Mult.	Weight	Unit Cost
250082-D	317DSPT	1-1/2" Camoflged Padlock	1/4/24	.518	13.49 EA

Master Lock

Hitch Pin Padlock - Class III/IV receiver hitch lock; 5/8" pin and model No. 151 covered brass 2" lock. Hardened receiver pins for increased sheer strength. Precision pin tumbler mechanism resists picking. Does not require a key to lock. Model No. 373 fits 2" square receiver tube (class III/IV).



Product No.	Mfg. No.	Description	Order Mult.	Weight	Unit Cost
250740-D	373DAT	Hitch Pin Padlock	1/4/24	.992	12.49 EA

Master Lock

Padlock - 1-3/4" wide 4-pin tumbler. Tough, laminated cadmium rustproofed steel case with case-hardened steel shackle. Shackle diameter 5/16". Clearance: Horizontal 3/4", vertical 15/16". Dual steel locking levers independently lock each shackle leg for increased protection. Removable key-change number for added security. Comes with pair of brass keys. Numbers following KA in pricing designates key number. All items ordered from that SKU number would be keyed alike to that number.



Product No.	Mfg. No.	Description	Order Mult.	Weight	Unit Cost
214547-D	1	Keyed different, boxed	1/6/24	.566	9.99 EA
220329-D	1KALJ	2-1/2" shackle, keyed alike, boxed	1/6/24	.566	14.49 EA
221655-D	1KA Series	Keyed alike, boxed	1/6/24	.566	11.99 EA
221717-D	1D	Keyed different, carded	1/6/24	.566	11.99 EA

Continued Next Column

Continued From Previous Column

Product No.	Mfg. No.	Description	Order Mult.	Weight	Unit Cost
221744-D	1LJ	Extra length, 2-1/2 shackle clearance, 1 per box	1/6/24	.566	11.99 EA
226203-D	1DLJ	Extra length, 2-1/2 shackle clearance, carded	1/6/24	.542	10.99 EA
226211-D	1TRILJ	Extra length, 2-1/2 shackle clearance, 3 pack keyed alike	1/6/24	.566	10.99 EA
223332-D	1D	1-3/4" Padlock	1/4/24	.566	9.99 EA
234213-D	1LJ	2-1/2" Shackle Padlock	1/6/24	.644	12.99 EA
205672-D	1DLJ	2-1/2" Shackle Padlock	1/6/24	.566	12.79 EA
212318-D	1TRILJ	Lg Shackle Padlock	1/4/16	1.858	27.49 EA

Master Lock

Universal Pin Padlock - For use with Master Lock's universal pin keying system. 1-3/4" wide pin tumbler. Tough laminated cadmium rustproofed steel case with case-hardened steel shackle. Shackle diameter 5/16". Horizontal clearance: 3/4". Dual steel locking levers independently lock each shackle leg for increased protection.



Product No.	Mfg. No.	Description	Order Mult.	Weight	Unit Cost
244015-D	1UP	Vertical clearance 15/16"	1/6/24	1.035	10.49 EA
244007-D	1UPLJ	Extra length shackle, vertical clearance 2-1/2"	1/6/24	.913	13.49 EA

Master Lock

EX Series - 4-pin cylinder. Fully shrouded EX Series make prying and cutting more difficult. The reinforced shroud, laminated steel lock body, and hardened steel shackle provide maximum resistance to attack. 2 keys per padlock.



Product No.	Mfg. No.	Description	Order Mult.	Weight	Unit Cost
221996-D	1DEX	1-3/4" wide, 5/16" shackle diameter, clearance: 13/16" vertical, 25/32" horizontal	1/4/24	.673	11.99 EA
222003-D	3DEX	1-1/2" wide, 9/32" shackle diameter, clearance: 3/4" vertical, 5/8" horizontal	1/4/24	.560	11.49 EA

Master Lock

Padlock - 2" wide 4-pin tumbler. Tough, laminated, cadmium rustproofed steel case; special alloy steel shackle. Shackle diameter 3/8". Dual steel locking levers independently lock each shackle leg for increased protection. Removable key-change number for added security. Shackle clearance: Horizontal 15/16"; vertical 1". Comes with 2 brass keys. Numbers following KA in pricing designates key number. All items ordered from that SKU number would be keyed alike to that number.



Product No.	Mfg. No.	Description	Order Mult.	Weight	Unit Cost
223341-D	5D	Keyed different, carded	1/4/24	.857	12.79 EA
252204-D	5DLFPF	Padlock 1-1/2" shackle	1/4/24	.879	14.99 EA
222280-D	5KA Series	Keyed alike, boxed	1/6/24	.833	13.79 EA
225312-D	5T	Keyed alike twin pack, carded	1/6/36	.833	13.79 EA
244058-D	5T	2pk 2" Padlock	1/6/24	1.692	22.49 EA

MASTERLOCK

Master Lock

Universal Pin Padlock - For use with Master Lock's universal pin keying system. 2" wide laminated case. 4-pin tumbler security. Dual steel levers lock both sides of case-hardened, 3/8" diameter steel shackle. 15/16" horizontal clearance.



Product No.	Mfg. No.	Description	Order Mult.	Weight	Unit Cost
243965-D	5UP	Vertical clearance 1"	1/6/24	.801	12.79 EA
243957-D	5UPLF	Extra length shackle, vertical clearance 1-1/2"	1/6/24	.889	15.79 EA

Master Lock

Padlock - 1-1/2" wide laminated steel case. Cadmium rustproofing. Self-locking steel swivel shackle, nickel-plated, diameter 1/4". Clearances: Vertical 5/8", horizontal 9/16". 2 nickel-plated steel keys, 40 key changes. Numbers following KA in pricing designates key number. All items ordered from that SKU number would be keyed alike to that number.



Product No.	Mfg. No.	Description	Order Mult.	Weight	Unit Cost
214459-D	22D	Keyed different	1/4/24	.407	3.29 EA
251453-D	22KA	Keyed alike, boxed	1/12/72	.353	4.29 EA
213646-D	22T	Twin pack - 2 keyed alike, carded	1/4/16	.745	6.79 EA
213527-D	3009D	4 pack - 4 keyed alike, carded	1/4/16	.895	10.79 EA

Master Lock

Padlock - 2" wide chrome-plated solid steel body is strong, durable and resists rust and corrosion. Dual ball locking for added protection from prying and hammering. Hardened steel shackles for added protection from cutting and sawing. 5-pin cylinder for maximum pick resistance.



Product No.	Mfg. No.	Description	Order Mult.	Weight	Unit Cost
252174-D	532DPFSEN	2" Steel Padlock	1/4/24	.968	14.99 EA

Master Lock

Padlock - 1-3/4" wide chrome-plated solid steel body is strong, durable and resists rust and corrosion. Dual ball locking for added protection from prying and hammering. Hardened steel shackles for added protection from cutting and sawing. Shackle shroud for added resistance to cutting and sawing. 5-pin cylinder for maximum pick resistance.



Product No.	Mfg. No.	Description	Order Mult.	Weight	Unit Cost
252182-D	533DPF	1-3/4" Steel Padlock	1/4/24	.771	22.99 EA

HARDWARE

Master Lock

Padlock - 1-1/2" wide solid aluminum body is lightweight, durable, and resists corrosion. Dual ball locking for added protection from prying and hammering. Hardened steel shackles for added protection from cutting and sawing. 5-pin cylinder for maximum pick resistance. Keyed different, 2" shackle and vertical clearance.



Product No.	Mfg. No.	Description	Order Mult.	Weight	Unit Cost
252263-D	570DLHPF	1-1/2" Padlock	1/4/24	.613	12.49 EA

Master Lock

Padlock - 1-3/4" wide solid brass body is strong, durable, and resists corrosion. Dual ball locking for added protection from prying and hammering. Hardened steel shackles for added protection from cutting and sawing. 5-pin cylinder for maximum pick resistance. 2" shackle.



Product No.	Mfg. No.	Description	Order Mult.	Weight	Unit Cost
252190-D	576DLHPF	1-1/2" Sb Padlock	1/4/24	.675	14.99 EA

Master Lock

Shrouded Padlock - Front access keyway for ease of use. Shrouded hardened steel shackle protects against cutting. 1-3/4" wide chrome-plated zinc body for strength and durability. Matching covered key heads for easy identification. 2-position adjustable shackle. Shackle dimensions: A: 1/4", B: 5/8" to 1-1/2", C: 3/4". Keyed different. Grey body with black bumper.



Product No.	Mfg. No.	Description	Order Mult.	Weight	Unit Cost
212335-D	194D	1-3/4" Shrouded Padlock	1/4/24	.438	10.99 EA

Master Lock

Corrozex Padlock - Rustproof 1-1/2" laminated steel padlock with chrome-plated shackle, 4-pin cylinder in silver vein colors. High-security pin tumbler mechanism resists tampering against sawing and cutting. The Corrozex coating, locks out harsh weather conditions. A lifetime - no rust guarantee. 9/32" shackle diameter, clearance 1-1/8" vertical and 5/8" horizontal. 2 keys per padlock.



Product No.	Mfg. No.	Description	Order Mult.	Weight	Unit Cost
222135-D	380D	Keyed different	1/4/24	.517	9.79 EA
222151-D	380T	Twin pack, 2 keyed alike	1/4/16	.984	17.49 EA

Master Lock

Covered Brass Padlock - Solid brass. Vinyl covers protect the lock body as well as surrounding surfaces. Lock body is constructed of solid brass for improved corrosion-resistance. Hardened steel shackles protect against sawing and cutting.



Product No.	Mfg. No.	Description	Order Mult.	Weight	Unit Cost
212380-D	121T	3/4" wide; 3-pin tumbler, solid black covered body with standard steel shackle, 2 pack keyed alike A: 5/32", B: 7/16", C: 1/4"	1/4/24	.200	6.29 EA
221872-D	131D	1-3/16" wide, 3/16" shackle diameter, clearance: 5/8" vertical and 9/16" horizontal, black	1/4/24	.219	5.29 EA
224405-D	131Q	4 pack, black, 1-3/16" wide, 3/16" shackle diameter, clearance: 5/8" vertical, 9/16" horizontal	1/4/16	.739	15.49 EA
212326-D	131T	1-3/16" wide, A: 3/16", B: 5/8", C: 9/16", black, 2 pack keyed alike, black cover	1/4/16	.376	9.29 EA
221880-D	141D	1-9/16" wide, 1/4" shackle diameter, clearance: 13/16" vertical and 13/16" horizontal, black	1/4/24	.350	6.79 EA
224448-D	141T	2 pack, black, 1-9/16" wide, clearance: 13/16" vertical, 13/16" horizontal	1/4/16	.650	12.49 EA

Master Lock

Brass Padlock - Solid brass. Corrosion-resistant case with satin brass finish. Brass cylinder, pin tumbler locking mechanism. Case-hardened steel shackle. 2 nickel-plated brass keys included. Carded.



Product No.	Mfg. No.	Description	Order Mult.	Weight	Unit Cost
200632-D	120T	Twin pack, 3/4" wide, 3-pin tumbler, 5/32" shackle diameter, clearance: 7/16" vertical and 3/8" horizontal	1/4/24	.193	5.99 EA
201332-D	120QUAD	4 pack, 3/4" wide, 3-pin tumbler, 5/32" shackle diameter, clearance: 7/16" vertical and 3/8" horizontal	1/4/16	.369	9.79 EA
219187-D	130D	1-3/16" wide, 4-pin tumbler, 3/16" shackle diameter, clearance: 5/8" vertical and 9/16" horizontal	1/4/24	.202	4.79 EA
219383-D	140D	1-9/16" wide, 4-pin tumbler, 1/4" shackle diameter, clearance: 7/8" vertical and 13/16" horizontal	1/4/24	.324	6.29 EA
201340-D	140T	Twin pack, 1-9/16" wide, 4-pin tumbler, 1/4" shackle diameter, clearance: 7/8" vertical and 3/16" horizontal	1/6/24	.708	11.49 EA
219338-D	150D	2" wide, 5-pin tumbler, 9/32" shackle diameter, clearance: 1" vertical and 1" horizontal	1/4/24	.477	10.49 EA
219374-D	160D	2-3/8" wide, 5-pin tumbler, 11/32" shackle diameter, clearance: 1-1/8" vertical and 1-1/4" horizontal	1/4/24	.490	12.79 EA

Master Lock

Padlock - Tough hard-wrought laminated brass. Corrosive-resistant. Brass cylinder. 4-pin tumbler, dual brass levers to independently lock each shackle leg. Case-hardened steel shackle. 2 brass keys. Carded.



Product No.	Mfg. No.	Description	Order Mult.	Weight	Unit Cost
205613-D	2D	1-3/4" wide, 5/16" shackle diameter, clearance: 15/16" vertical and 3/4" horizontal	1/6/24	.583	14.99 EA
205621-D	4D	1-1/2" wide, 9/32" shackle diameter, clearance: 3/4" vertical and 5/8" horizontal	1/6/36	.708	12.79 EA
205648-D	6D	2" wide, 3/8" shackle diameter, clearance: 1" vertical and 15/16" horizontal	1/6/24	.875	18.49 EA
205656-D	8D	1-1/8" wide, 3/16" shackle diameter, clearance: 9/16" vertical and 1/2" horizontal	1/6/36	.222	10.49 EA

Master Lock

Resettable Combination Lock - Corrosion-resistant solid brass case. Nickel-plated, case-hardened steel shackle 5/16" thick. Independently double-locking shackle legs. Combination changer fully protected from tampering while lock is closed. Positive-action change key. Carded.



Product No.	Mfg. No.	Description	Order Mult.	Weight	Unit Cost
200589-D	175D	1" vertical shackle clearance	1/4/24	.500	22.49 EA
200687-D	175DLH	2-1/4" vertical shackle clearance	1/6/36	.583	24.49 EA

Master Lock

Round Padlock - Rekeyable. 5-pin tumbler. Replaceable case-hardened 7/16" shackle. Dual hardened steel balls lock each shackle leg independently. Rust-resistant. Triple-plated copper nickel chrome finish. Keyed differently. Carded.



Product No.	Mfg. No.	Description	Order Mult.	Weight	Unit Cost
200712-D	220DPF	2" wide, shackle clearance: 1" vertical, 3/4" horizontal	1/6/24	.833	22.99 EA
200801-D	230DPF	2-1/2" wide, shackle clearance: 1" vertical, 15/16" horizontal	1/6/24	1.292	26.99 EA

Master Lock

Disc Padlock - 2-3/4" wide stainless steel body with hardened steel shackle. Small shackle opening minimizes attacks by bolt cutters, saws, files, etc. Includes 2 keys. Shackle diameter 3/8", vertical and horizontal clearance 3/4". Carded.



Product No.	Mfg. No.	Description	Order Mult.	Weight	Unit Cost
244066-D	40DPF	2-3/4" Disc Padlock	1/4/24	.924	15.99 EA

Master Lock

Stainless Steel Combination Padlock - Keyless convenience. Smooth 3-number dialing. Strong double-wall construction. Stainless steel outer case encloses heavy wrought steel inner case. Permanently lubricated rust-resistant inner working parts. Dial cannot be turned when shackle is under tension, safe guarding combination. Self-locking, automatically disarranging tumblers. Case: 1-7/8" wide. Nickel-plated steel swivel shackle, diameter 9/32". Clearances: 3/4" vertical, 13/16" horizontal. Combinations different.



Product No.	Mfg. No.	Description	Order Mult.	Weight	Unit Cost
214850-C	1500D	Carded, black dial	1/6/24	.389	4.79 EA
219329-D	1500T	Twin pack, combinations alike, black dial	1/4/16	.779	10.99 EA
216593-D	1504D	Carded, red dial	1/4/24	.389	6.79 EA
216682-D	1506D	Carded, blue dial	1/4/24	.389	6.79 EA

Master Lock

Armorlock Padlock - 1-1/2" wide laminated steel case. 4-pin tumbler. Revolving case-hardened shackle-guard. Rust-resistant nickel-plated and armour. Shackle clearance, vertical 15/16", horizontal 7/16". Comes with 2 brass keys. Resists saws and bolt cutters. For use with cables, chains or hasps. For guarding trailer on or off vehicle. Carded.



Product No.	Mfg. No.	Description	Order Mult.	Weight	Unit Cost
221316-D	37D	1-1/2" Armorlock Padlock	1/4/24	.705	15.49 EA

Master Lock

Laminated Steel Padlock - Designed to meet the needs of contractors and small businesses. 2-1/8" wide reinforced laminated steel body. Hardened boron alloy shackle for maximum cut resistance. 5-pin cylinder helps prevent picking. Dual ball bearing locking for maximum pry-resistance. Flex Fit™ keyway cover minimizes jamming. 5/16" shackle diameter, 1-1/8" vertical and 7/8" horizontal.



Product No.	Mfg. No.	Description	Order Mult.	Weight	Unit Cost
224480-D	911DPF	2-1/8" Padlock	1/4/24	1.116	21.49 EA

Master Lock

High Security Padlock - Die-cast and solid steel body. Hardened boron alloy shackle for superior cut resistance. 5-pin tumbler cylinder for added security. Removable cylinder can be replaced or repinned. Industrial grade materials to withstand attacks. 2 keys included. Carded.

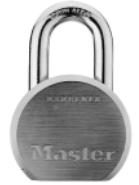

Product No.	Mfg. No.	Description	Order Mult.	Weight	Unit Cost
224464-D	930DPF	2-1/2" wide, 7/16" shackle diameter, clearance: 1-1/8" vertical, 7/8" horizontal	1/4/24	1.483	27.99 EA
224472-D	930DLHPF	2-1/2" wide, 7/16" shackle diameter, clearance: 2" vertical 7/8" horizontal	1/4/24	1.500	31.49 EA

Master Lock

Shrouded Padlocks - 2-1/8" wide body. Designed to meet the needs of contractors and small businesses. Solid metal shroud for maximum pry and cut-resistance. Reinforced laminated steel body for superior strength. Hardened boron alloy shackle for maximum cut-resistance. Removable 5-pin cylinder helps prevent picking. Dual ball bearing locking for maximum pry-resistance. 5/16" shackle diameter, clearance: 3/4" vertical and 7/8" horizontal.



Product No.	Mfg. No.	Description	Order Mult.	Weight	Unit Cost
224499-D	931DPF	2-1/8" Shrouded Padlock	1/4/24	1.483	29.49 EA

Master Lock

Combination Padlock - This twice as pry resistant as other combination padlocks is also scratch proof with an ABS plastic cover, around a titanium reinforced high-strength body. Dual ball bearing locking mechanism and hardened steel shackle makes this padlock bolt-cutter tough. The combination scrambles when closing shackle automatically safeguarding your possessions. Body: 1-7/8" wide. Shackle dimensions: A: 1/4, B: 15/16", C: 15/16". Color: Black. Carded.



Product No.	Mfg. No.	Description	Order Mult.	Weight	Unit Cost
213535-C	2050XD	Combination Padlock	1/4/24	.792	10.49 EA

Master Lock

Access Key Storage - You no longer have to hide the key under a mat or in the flower pot. Key storage compartment holds over 5 door or car keys. Resettable combination, select a 4-digit number that you will remember. Solid die-cast body is reinforced to withstand hammering and sawing. Zinc lock body and shutter are weather-resistant for years of dependable operation. Molded bumper and vinyl-coated shackle prevent scratches to your door. Attractive design blends with decor to minimize attention. Choose the moveable shackle mount or the permanent wall mount. The wall mount will fasten to any wall, screws are included.



Product No.	Mfg. No.	Description	Order Mult.	Weight	Unit Cost
203112-C	5400D	Moveable with shackle, 3-9/16"	1/0/4	.500	32.49 EA
203121-C	5401D	Wall mount, 3-3/8"	1/0/4	.500	31.49 EA

Master Lock

Python Adjustable Locking Cable - 6' x 3/8" cable. The Python adjustable locking cable adjusts to perfectly fit a wide range of security needs. Cut-resistant 100% steel braided cable. Tie-down convenience, hold feature prevents slack when cinching cable tight. Ultimate flexibility, cable length adjusts from 1' to 6'. Velcro strap holds excess cable. Nonscratch vinyl-coated cable. Rust-resistant lock body and cable. 3 key positions.



Product No.	Mfg. No.	Description	Order Mult.	Weight	Unit Cost
257540-B	8413XDPF	6 Locking Cable	1/0/6	1.633	22.49 EA

Master Lock

Self-Coiling Cable - Clear vinyl, 1/4" diameter cable. 6' long. 2500 lb. pull strength.



Product No.	Mfg. No.	Description	Order Mult.	Weight	Unit Cost
209526-D	65D	6 Self-coiling Cable	1/2/16	.696	6.79 EA

Master Lock

Bike Lock - 4-wheel barrel combination lock. Extra-long, extra-tough, self-coiling 4' steel cable. 3/16" diameter. Vinyl coating protects bike finish. Carded.



Product No.	Mfg. No.	Description	Order Mult.	Weight	Unit Cost
239828-D	8143DSG	4 Cable Bike Lock	1/6/48	.713	6.29 EA

Master Lock

6' Cable Lock - Integrated cable and lock mechanism with keyway cover to guard against jamming and freezing. Self-coiling vinyl coated cable prevents marring and scratching. 3/16" diameter cable. 2 brass keys. Carded.



Product No.	Mfg. No.	Description	Order Mult.	Weight	Unit Cost
201316-D	8124DSG	6 Cable Lock	1/6/24	.313	13.49 EA

Master Lock

Steel Cables - Cable with loops. 3/8" diameter, 6' long, braided steel cable with loops. Steel wires for strength and flexibility. Galvanized steel cable and protective sleeves for superior rust resistance. Vinyl coating to help prevent scratching. Recommend use with laminated locks, solid steel locks, and mini U-locks.



Product No.	Mfg. No.	Description	Order Mult.	Weight	Unit Cost
252220-D	78DPF	6 Steel Cable	1/4/16	1.148	9.49 EA

Master Lock

Braided Steel Cable - Heavy-duty cable 4" length 3/8" outside diameter of cable/chain. Galvanized steel cable resists rusting. Braided steel wires for strength steel wires for strength and flexibility. Black vinyl coating helps prevent scratching. Convenient loops with rust-resistant sleeves and scratch guards. Recommended use with laminated, solid steel and mini U-locks.



Product No.	Mfg. No.	Description	Order Mult.	Weight	Unit Cost
212371-D	85DPF	4 Braided Steel Cable	1/4/16	1.024	8.29 EA

Master Lock

Resettable Combination Cable Lock - 3/8" diameter, 5' long, braided steel cable with resettable combination is personalizable with your easy to remember code. Steel wires for strength and flexibility. Vinyl coating to help prevent scratching.



Product No.	Mfg. No.	Description	Order Mult.	Weight	Unit Cost
252212-D	8119DPF	5 Resettable Cable Lock	1/4/16	1.616	14.99 EA

Master Lock

Integrated Keyed Cable Lock - 3/8" diameter, 6' long, braided steel cable with integrated keyed locking mechanism for strong pick resistance. Vinyl coating to help prevent scratching.



Product No.	Mfg. No.	Description	Order Mult.	Weight	Unit Cost
252239-D	8154DPF	6 Keyed Cable Lock	1/4/16	1.317	13.99 EA

Master Lock

Combination Padlock Cable - Flexible intertwined steel aircraft cable, red vinyl coated. Permanently attached to Master model No. 1500 combination padlock, 1-7/8" wide stainless steel case. 3-number dialing, automatic locking inner parts rust-resistant. Handy to carry, easy to use. Carded.



Product No.	Mfg. No.	Description	Order Mult.	Weight	Unit Cost
239771-D	1519D	Combination Padlock Cable	1/6/48	.215	11.49 EA

Master Lock

U-lock - 3-11/16" wide steel lock body for strength. Double locking shackle for maximum pry resistance. Hardened steel shackle resists cutting and sawing. Vinyl-covered body and shackle prevents scratching. 7-pin tumbler for extreme pick resistance. Ideal for use with heavy-duty cable and chain. Black.



Product No.	Mfg. No.	Description	Order Mult.	Weight	Unit Cost
252247-D	8118DPF	Mini U-lock	1/4/24	.289	21.99 EA

Master Lock

Safety Hasp - Rugged security hasp that matches the Master padlocks. Patented design. Heavy hard wrought steel, ribbed for maximum strength. Tapered design, with rolled edges to conceal screws and prevent prying. Exclusive pinless hinge for added security. Cadmium rustproofing. Extra strong rounded staple of hardened steel. Complete with 7 screws.



Product No.	Mfg. No.	Description	Order Mult.	Weight	Unit Cost
200302-D	703D	3-1/2"	1/4/24	.279	4.29 EA
214976-D	704DPF	4-1/2"	1/4/24	.487	5.29 EA

Master Lock

Safety Hasp - 6" hardened steel super security hasp, with reinforced hinge. Made especially for big padlocks, such as the Master No. 15 series. Tapered design, with rolled edges to conceal screws and prevent prying. Ribbed for maximum strength. Cadmium rustproofing. Extra strong rounded staple of hardened alloy steel. Complete with 9 mounting screws plus 2 bolts for added strength when needed.



Product No.	Mfg. No.	Description	Order Mult.	Weight	Unit Cost
221156-D	706D	6" Safety Hasp	1/4/24	.948	10.49 EA

Master Lock

Hasplock - Rugged 1-3/4" wide laminated steel attached to heavy-duty slide bolt and 4-1/2" steel hasp. Pinless hinge. Tapered with rolled edges to conceal screws. Cadmium rustproofing. 7 screws and 2 keys. Maximum protection for homes, garages, sheds, and trucks. 6 per carton.



Product No.	Mfg. No.	Description	Order Mult.	Weight	Unit Cost
208901-D	475D	4-pin Hasp Lock	1/6/36	1.111	18.79 EA

Master Lock

Hasplock - Warded security in a laminated steel hasplock. Combines sturdy 4-1/2" steel hasp, heavy slide bolt and 1-3/4" wide laminated steel padlock. All in 1 handy unit. Works on doors, opening either right or left. Powerful pinless hinge. Extra-strong rounded staple of hardened steel. Tapered design, with rolled edges to conceal screws. Cadmium rustproofing. Complete with 7 cadmium plated screws. 2 nickel-plated steel keys, 60 changes. Keyed differently.



Product No.	Mfg. No.	Description	Order Mult.	Weight	Unit Cost
214967-D	450D	Hasplock	1/4/24	1.087	13.79 EA

Master Lock

High-Security Single Hinge Hasp - Hardened steel hasp with a hardened boron alloy staple for maximum strength. Protects against cutting and sawing. Rolled edges protect against prying and conceal mounting screws. Single hinge design for most corners and angles to secure hard to lock property. 6-1/4".



Product No.	Mfg. No.	Description	Order Mult.	Weight	Unit Cost
201375-D	720DPF	6-1/4" Sgl Hinge Hasp	1/4/24	.750	9.99 EA

Master Lock

High-Security Double Hinge Hasp - 7-3/4". Hardened steel hasp with a hardened boron alloy staple for maximum strength. Protects against cutting and sawing. Rolled edges protect against prying and conceal mounting screws. Double hinge design for the most corners and angles to secure hard-to-lock property.



Product No.	Mfg. No.	Description	Order Mult.	Weight	Unit Cost
201405-D	722D	7-3/4" Dbl Hinge Hasp	1/4/24	.958	11.49 EA

Master Lock

Straight Bar Hasp - 7-1/4". Zinc-plated hardened steel for added strength and weatherability. Hardened steel staple resists cutting, sawing, and hammering. Hasp body conceals mounting hardware. Mounting hardware included for easy installation.



Product No.	Mfg. No.	Description	Order Mult.	Weight	Unit Cost
252255-D	730DPF	Straight Bar Hasp	1/4/24	1.458	9.79 EA

National Mfg.

Coat And Hat Hook - National's catalog No. V160. Die-cast zinc. Projection: 3". Packed 2 each in visual pack with screws.



Product No.	Mfg. No.	Description	Order Mult.	Weight	Unit Cost
234721-C	N154575	Bright brass	5/0/25	.234	2.79 PK
242144-C	N192781	Nickel	1/5/25	.237	2.29 PK
200069-C	N248369	White	1/5/20	.210	2.79 PK

National Mfg.

Gallery Series Single Clothes Hook - 162 series. Single hook designed to be mounted on a door or wall to hold coats, hats, and other garments. Decorative ball tip design. Zinc die-cast.



Product No.	Mfg. No.	Description	Order Mult.	Weight	Unit Cost
214994-E	N327676	White, 2 per bag	1/15/75	.025	2.79 BG
214985-E	N243733	Bright brass, 2 per bag	1/10/40	.031	2.79 BG
215007-E	N274183	Chrome, 2 per bag	1/15/60	.031	2.79 BG
215010-D	N330795	Oil rubbed bronze, 2 per card	1/5/25	.045	2.79 CD
215023-D	N325498	Pewter, 2 per card	1/5/25	.045	2.79 CD
215038-D	N325506	Satin nickel, 2 per card	1/5/25	.045	2.79 CD

National Mfg.

Spring Hinge - Polished brass finish. 2" x 1-3/4". Packed 2 per card with screws.



Product No.	Mfg. No.	Description	Order Mult.	Weight	Unit Cost
243361-C	N240481	2" Brs Spring Hinge	1/5/30	.642	4.49 CD

National Mfg.

Sash Lift - Manufactured of cold-rolled steel. Designed for use with double-hung and sliding windows, small doors, and other applications. Size: 1-1/2". Bright brass finish. Packed 2 each in a visual pack with screws.



Product No.	Mfg. No.	Description	Order Mult.	Weight	Unit Cost
242349-C	N115691	Bb Sash Lift	1/5/25	.115	2.79 EA

National Mfg.

Surface Bolt - Gallery Series. Solid brass. Polished brass finish. For casement windows and French, twin, or Dutch doors. Extra long throw with bolt held in position by tension spring. Will not mar wood surface. Includes concealed base. Universal and mortise strikes. Available in 2", 3", and 4".



Product No.	Mfg. No.	Description	Order Mult.	Weight	Unit Cost
241288-C	N197962	2" Surface Bolt	1/5/15	.172	5.29 EA
216590-C	N197970	3" Surface Bolt	1/5/15	.175	6.29 EA
241296-C	N197988	4" Surface Bolt	1/5/15	.268	6.29 EA

Tell Mfg. Inc.

Strap Bolt - 8" strap bolt, brushed chrome steel (26D). Screws included.

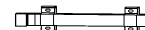

Product No.	Mfg. No.	Description	Order Mult.	Weight	Unit Cost
201720-D	SB42826	8" Chr Strap Bolt	1/0/10	1.100	29.99 EA

Baldwin Hdwe.

Surface Bolt - Solid extruded brass. Polished brass finish. Concealed screw installation. Tension spring holds bolt in position. Universal and mortise strikes and screws included.

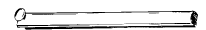

Product No.	Mfg. No.	Description	Order Mult.	Weight	Unit Cost
222941-D	0322-030	4" length	1/0/10	.220	19.79 EA
234192-D	0324-030	6" length	1/0/10	.325	22.49 EA

DOOR STOPS

HARDWARE

National Mfg.

Spring Door Stop - National's catalog No. V230. Die-cast zinc base. Flexible stop with 3" projection. Has sharply pointed drive screw. Nonmar tip. Packed 2 each in visual pack.



Product No.	Mfg. No.	Description	Order Mult.	Weight	Unit Cost
234482-C	N126607	Bright brass	1/5/25	.090	1.49 PK
235873-D	N159020	Antique brass	1/5/25	.090	1.79 PK

National Mfg.

Door Stop Tips - Manufactured of durable nomar plastic. For use with National's catalog No. V230 and V231 door stops. White finish. Packed 6 each in a visual pack.



Product No.	Mfg. No.	Description	Order Mult.	Weight	Unit Cost
242047-C	N181404	Wht Door Stop Tips	1/5/25	.028	.89 PK

National Mfg.

Rigid Door Stop - Solid die-cast zinc stop with 3" projection. Nonmar tip. Bright brass finish. Packed 2 each in a visual pack.



Product No.	Mfg. No.	Description	Order Mult.	Weight	Unit Cost
234428-D	N154492	3" Brs Rigid Door Stop	1/5/25	.142	1.79 PK

National Mfg.

Broad Spring Door Stop - Die-cast zinc base. Steel wire spring with wide base for better support. White nomar tip. 3" projection. Bright brass finish. Packed 2 each in a visual pack with screws.



Product No.	Mfg. No.	Description	Order Mult.	Weight	Unit Cost
242055-D	N184291	Brs Door Spring Stop	1/5/25	.772	1.99 PK

National Mfg.

Floor Door Stop - Die-cast zinc angle stop with nonmar tip. Packed 1 each in a visual pack with screws. Bright brass finish.



Product No.	Mfg. No.	Description	Order Mult.	Weight	Unit Cost
234151-C	N154500	Bb Floor Door Stop	1/5/30	.103	1.49 PK

National Mfg.

Hinge Door Stop - National's catalog No. V234. Die-cast zinc. Mounts easily on door hinges by removing hinge pin, sliding stop over the pin and reinserting the pin in the hinge. Adjusts without tools to control how far the door opens. 1-7/8" projection. Packed 1 each in visual pack.



Product No.	Mfg. No.	Description	Order Mult.	Weight	Unit Cost
234124-C	N154526	Bright brass	1/5/25	.120	1.99 PK
242063-D	N159046	Antique brass	1/5/25	.125	2.29 PK
256560-C	N248401	White	1/5/50	.129	2.29 PK

National Mfg.

Soft Jamb Door Stop - Molded plastic body with a steel screw. 3-1/4" projection. 1-piece flexible design. Will not rust. Childproof; no loose cap to swallow, no springs to pinch, and no sharp edges to cut. White finish. Packed 2 each in a visual pack.



Product No.	Mfg. No.	Description	Order Mult.	Weight	Unit Cost
242071-D	N191510	Soft Jam Door Stop	1/5/25	.388	2.29 PK

National Mfg.

Heavy-Duty Rigid Door Stop - National's catalog No. V238. Die-cast zinc body with a rubber tip. 3" projection. Decorative design. Packed 2 each in a visual pack.



Product No.	Mfg. No.	Description	Order Mult.	Weight	Unit Cost
242098-C	N199372	Bright brass	1/5/25	.218	2.79 PK
203835-C	N273599	Satin chrome	1/5/30	.232	2.79 PK

National Mfg.

Kickdown Door Stop - National's catalog No. V238. Die-cast zinc body with a rubber tip. Ribbed rubber tip for positive holding. Spring design holds the stop in the up position. Length of arm 4". Packed 1 each in a visual pack with screws. Refer to model No. N225557 for replacement tip.



Product No.	Mfg. No.	Description	Order Mult.	Weight	Unit Cost
242101-C	N184259	Bright brass	1/5/25	.380	3.79 PK
242128-C	N184275	Chrome	1/5/25	.381	3.79 PK

Universal

Magnetic Door Stop And Holder - Functions as door stop and/or door holder. Manufactured of zinc die-cast. Open the door fully and the magnet will hold it in place. Pull the door gently to release. Ideal for offices, homes, and many other places. Screws included.



Product No.	Mfg. No.	Description	Order Mult.	Weight	Unit Cost
207369-C	MDHCUS15	Satin nickel finish	1/0/10	.500	13.49 CD
207378-C	MDHCUS3	Brass finish	1/0/10	.500	16.49 CD

The product representations in this catalog are for reference only, and are subject to change without notice.

National Mfg.

Softstop® Door Stop - Air cushioned door stop. Protects walls. Covers minor damage or marks on wall. Easy installation. Permanent self-adhesive backing. Soft plastic. 2-3/8" diameter. 1" projection. 2 per card.

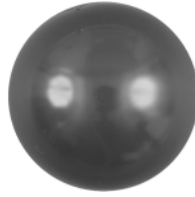

Product No.	Mfg. No.	Description	Order Mult.	Weight	Unit Cost
209147-D	N213587	Brown	1/0/5	.100	4.29 CD
209155-D	N213579	Almond	1/0/5	.100	4.29 CD
209163-D	N213561	White	1/0/5	.100	4.29 CD

National Mfg.

Softstop® Cover-Up - Octagonal shape. 5" x 5". Covers previous wall damage. Protects wall from door knob damage. Cushions door impact. Easy installation. Permanent self-adhesive backing. Hard plastic cover-up with soft plastic door stop. Size: 5" x 5". 1-1/2" projection.



Product No.	Mfg. No.	Description	Order Mult.	Weight	Unit Cost
209112-D	N213595	Almond	1/0/2	.500	5.99 CD
256501-C	N246041	White	1/2/18	.432	5.29 PK

National Mfg.

Wedge Door Stop - Holds door with up to 1-1/2" clearance. Flexible rubber. Brown. 2 per card.



Product No.	Mfg. No.	Description	Order Mult.	Weight	Unit Cost
232149-D	N213603	5" Wedge Door Stop	1/0/5	.380	4.79 CD

National Mfg.

Handrail Bracket - Complete in a visual pack with 1-1/2" x 10 oval head screws for handrail straps.



Product No.	Mfg. No.	Description	Order Mult.	Weight	Unit Cost
217937-C	N159566	Handrail bracket, antique brass finish, 1 per pack	1/5/25	.363	3.79 PK
235800-C	N112888	Handrail bracket, brass finish, 1 per pack	1/5/40	.373	2.99 PK
200050-C	N248351	Handrail bracket, white, finish, 1 per pack	1/5/25	.366	3.49 PK

National Mfg.

Gallery Series Handrail Bracket - 112 series. Designed to secure wooden handrail to a wall, stud, or other structurally sound surface. Bracket and strap are designed to adjust to any stairway angle. Zinc die-cast.



Product No.	Mfg. No.	Description	Order Mult.	Weight	Unit Cost
214896-D	N327627	White, 1 per bag	1/10/50	.061	3.79 BG
214903-D	N243667	Bright brass, 1 per bag	1/10/40	.076	3.29 BG
214912-D	N274266	Chrome, 1 per bag	1/10/100	.031	3.79 BG
214921-D	N330738	Oil rubbed bronze, 1 per card	1/5/25	.067	3.99 CD
214958-D	N325530	Pewter, 1 per card	1/5/25	.067	3.79 CD
214973-D	N325548	Satin nickel, 1 per card	1/5/25	.067	3.79 CD

National Mfg.

Single Clothes Hook - National's catalog No. V162. Die-cast zinc. Projection: 1-9/16". Base: 1". Packed 2 each in a visual pack with screws.



Product No.	Mfg. No.	Description	Order Mult.	Weight	Unit Cost
242160-C	N199190	Nickel	1/5/25	.163	2.49 PK
242179-C	N199182	Bright brass	1/5/25	.163	2.49 PK
200077-C	N248377	White	1/5/25	.163	2.49 PK

National Mfg.

Double Clothes Hook - National's catalog No. V163. Die-cast zinc. Projection: 1-1/16". Base: 1". Packed 2 each in a visual pack with screws.



Product No.	Mfg. No.	Description	Order Mult.	Weight	Unit Cost
242187-C	N199224	Bright brass	1/5/25	.224	2.79 EA
242195-C	N199232	Nickel	1/5/25	.225	2.79 PK
200085-C	N248385	White	1/5/25	.224	2.79 PK

National Mfg.

Garment Hook - Die-cast zinc. Projection: 3-5/16". Height: 5-5/16". Packed 1 each in a visual pack with screws. Bright brass or white finish.



Product No.	Mfg. No.	Description	Order Mult.	Weight	Unit Cost
242209-D	N199265	Bb Garment Hook	1/5/25	.275	3.29 EA
200093-C	N248393	Wht Garment Hook	1/5/25	.275	3.49 PK

HOOKS

National Mfg.

Under Shelf Hook - Die-cast zinc. Mounts underneath flat surface. Packed 2 each in a visual pack. Bright brass, nickel, or white finish. Projection 2-1/2".



Product No.	Mfg. No.	Description	Order Mult.	Weight	Unit Cost
246832-C	N245811	Brs Under Shelf Hook	1/5/25	.288	3.49 PK
246840-C	N245837	Nkl Under Shelf Hook	1/5/25	.293	3.49 PK
246859-C	N245852	Wht Under Shelf Hook	1/5/25	.294	3.99 PK

H. B. Ives

Coat And Hat Hook - Artisan Series all-purpose hook in traditional design. Solid brass construction. Mounts anywhere. 3" projection.



Product No.	Mfg. No.	Description	Order Mult.	Weight	Unit Cost
200721-C	CP571MB619	Satin nickel finish (619)	1/0/5	.300	7.29 EA
219686-C	CP571MB-613	Oil rubbed bronze (613) finish	1/0/5	.300	7.29 EA

H. B. Ives

Single Wardrobe Hook - Artisan Series. Compact hook design, ideal for behind doors. Solid brass design. Traditional design fits any decor. 1-11/16" projection.



Product No.	Mfg. No.	Description	Order Mult.	Weight	Unit Cost
200730-C	CP581MB-619	Satin nickel (619) finish	1/0/5	.280	9.99 EA
219695-C	CP581MB-613	Oil rubbed bronze (613) finish	1/0/5	.280	9.99 EA
219908-C	CP581MB-620	Antique pewter (620) finish	1/0/5	.280	9.99 EA

H. B. Ives

Double Wardrobe Hook - Artisan Series. Compact hook design, ideal for behind doors. Solid brass design. Traditional design fits any decor. 1-1/8" projection.



Product No.	Mfg. No.	Description	Order Mult.	Weight	Unit Cost
200749-C	CP582MB-619	Satin nickel (619) finish	1/0/5	.280	11.49 EA
219702-C	CP582MB-613	Oil rubbed bronze (613) finish	1/0/5	.280	11.49 EA
219917-C	CP582MB-620	Antique pewter (620) finish	1/0/5	.280	11.49 EA

H. B. Ives

Coat And Hat Hook - Solid brass. Bright brass finish. 3" projection on top hook.



Product No.	Mfg. No.	Description	Order Mult.	Weight	Unit Cost
205030-D	C571MB3	Coat & Hat Hook	1/0/5	.300	6.29 CD

HARDWARE

H. B. Ives

Wardrobe Hook - Single hook. Solid brass. Bright brass finish. Base: 1-1/8" x 1-1/8". 1-11/16" projection.



Product No.	Mfg. No.	Description	Order Mult.	Weight	Unit Cost
205076-D	C581MB3	Wardrobe Hook	1/0/5	.140	4.49 CD

H. B. Ives

Wardrobe Hook - Double hook. Solid brass. Bright brass finish. Base: 1-1/8" x 1-1/8". 1-1/8" projection.



Product No.	Mfg. No.	Description	Order Mult.	Weight	Unit Cost
205307-D	C582MB3	Brs Wardrobe Hook	1/0/5	.300	5.49 CD

H. B. Ives

Coat And Hat Hook - 3" projection on top hook. Epoxy-coated aluminum. Bright brass finish. Bulk pack poly bag.



Product No.	Mfg. No.	Description	Order Mult.	Weight	Unit Cost
205405-D	SP571A3	Coat & Hat Hook	1/0/25	.076	.89 EA

H. B. Ives

Wardrobe Hook - Epoxy-coated aluminum. Bright brass finish. Bulk pack poly bag.



Product No.	Mfg. No.	Description	Order Mult.	Weight	Unit Cost
205441-D	SP581A3	Single hook 1-11/16" projection	1/0/50	.048	.99 EA
205450-C	SP582A3	Double hook 1-1/8" projection	1/0/25	.068	.99 EA

H. B. Ives

Handrail Bracket - Epoxy-coated aluminum. Base: 2-1/4" H. x 1-3/8" W. Bright brass finish. Bulk pack poly bag.



Product No.	Mfg. No.	Description	Order Mult.	Weight	Unit Cost
205316-D	SP059A3	Handrail Bracket	1/0/20	.160	1.79 EA

HARDWARE

National Mfg.

Zinc Plate Staple - Packed with screws.



Product No.	Mfg. No.	Description	Order Mult.	Weight	Unit Cost
210211-C	N236794	Plate size 1-1/16" x 1-1/8" has a staple projection of 9/16", for use with 3" and 4" hasps	0/0/20	.066	.99 EA
210220-D	N236802	Plate size 1-5/8" x 1-1/4" has a staple projection of 5/8", for use with 3-1/4", 4-1/2", and 6" hasps	0/0/20	.084	1.29 EA

National Mfg.

Zinc Hasp - For use on chests and boxes. All screws are covered when hasp is locked. Individually packed with screws in a visual pack.



Product No.	Mfg. No.	Description	Order Mult.	Weight	Unit Cost
234865-C	N103259	3-1/4" Double Hinge Hasp	1/5/40	.408	3.49 PK
210391-C	N103291	4-1/2" Double Hinge Hasp	1/5/40	.473	4.79 PK

National Mfg.

Safety Hasp - V30 series. Cold-rolled steel, all screws concealed. Packed in a visual pack with screws. Zinc, brass, or galvanized finish.

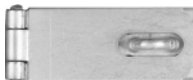

Product No.	Mfg. No.	Description	Order Mult.	Weight	Unit Cost
229265-C	N102178	2-1/2" Brs Safety Hasp	1/5/25	.167	1.99 PK
212825-D	N102020	1-3/4" Zinc Safety Hasp	1/5/100	.072	1.29 PK
234856-D	N102053	1-3/4" Brs Safety Hasp	1/5/50	.093	1.49 PK
210328-D	N102145	2-1/2" Zinc Safety Hasp	1/5/50	.134	1.79 PK
210337-C	N102277	3-1/4" Zinc Safety Hasp	1/5/30	.250	1.79 PK
210346-C	N102384	4-1/2" Zinc Safety Hasp	1/5/30	.331	2.49 PK
210319-C	N102459	6" Zinc Safety Hasp	1/5/50	.513	3.49 PK
234874-C	N102517	7" Zinc Safety Hasp	1/2/8	1.793	11.49 PK

National Mfg.

Draw Hasp - Draws, latches, and secures doors closed. Aligns door and jamb for a tight fit between door and door frame. Design of latch protects the padlock shackle and covers installation screws for ultimate security. Available zinc-plated in 2-3/4" or 4". Includes matching round head Phillips screws.



Product No.	Mfg. No.	Description	Order Mult.	Weight	Unit Cost
230715-D	N208512	2-3/4" Zinc Draw Hasp	1/5/25	.120	2.79 EA
230731-D	N210872	4" Zinc Draw Hasp	1/5/25	.380	4.49 EA

National Mfg.

Draw Hasp With Key Lock - Draws, latches, and secures doors closed. Aligns door and jamb for a tight fit between door and door frame. Specially designed built-in lock is pick-resistant for added security. 5" zinc-plated. Includes matching round head Phillips screws.



Product No.	Mfg. No.	Description	Order Mult.	Weight	Unit Cost
230782-D	N211003	5" Zinc Draw Hasp	1/2/10	.700	11.49 EA

National Mfg.

Door Pull - Wrought steel zinc finish. Packed with screws.



Product No.	Mfg. No.	Description	Order Mult.	Weight	Unit Cost
206985-C	N100115	6-1/2" overall, 1" x 9" screw size	1/5/30	.326	1.99 PK
207001-C	N100313	6-3/4" overall, 1" x 9" screw size	1/0/5	.388	2.49 PK
206574-D	N162594	Extra heavy 6-3/4", 1" x 9" screw size white vinyl-coated	1/5/15	.456	5.29 PK

National Mfg.

Door Pull - Cold-rolled steel. Packed in visual pack with 1" x 8" oval head screws. 1 per pack.



Product No.	Mfg. No.	Description	Order Mult.	Weight	Unit Cost
207029-C	N116715	6-1/2", zinc finish	1/5/25	.238	2.49 PK
234749-C	N116764	6-1/2", satin brass finish	1/5/25	.240	3.29 PK
206592-D	N116699	6-1/2", black finish	1/5/25	.258	3.29 PK
234730-C	N116889	5-1/2", satin brass finish	1/5/40	.184	2.79 PK
234758-C	N116855	5-1/2", zinc finish	1/5/40	.188	2.29 PK
206529-D	N116830	5-1/2", black finish	1/5/40	.187	2.79 PK

National Mfg.

Door Pull - 4-3/4" overall. Cold-rolled. Packed with 3/4" x 7" oval head screws. Visual pack.



Product No.	Mfg. No.	Description	Order Mult.	Weight	Unit Cost
207047-C	N117754	Brass finish	1/10/40	.063	1.49 PK
229247-D	N117713	Zinc finish	1/10/100	.090	1.29 PK
214639-C	N116731	BakEnamel finish	1/10/40	.091	1.49 EA

National Mfg.

Cane Bolt - Pinch-outs on bolts allow cane to be stored in the open position or locked in the closed position. Nonadjustable throw. Ornamental mounting brackets. Zinc-plated to resist rust. Satin black finish. 1/2" x 12".



Product No.	Mfg. No.	Description	Order Mult.	Weight	Unit Cost
218516-C	N165902	1/2x12 Blk Cane Bolt	1/5/15	1.085	7.29 PK

PULLS/LATCHES

HARDWARE

National Mfg.

Sash Lift - Cold-rolled steel. 4" overall length. Supplied in visual pack. Satin brass, bright brass, antique brass, white, and nickel finish. Packed 1 each in a visual pack with screws.



Product No.	Mfg. No.	Description	Order Mult.	Weight	Unit Cost
256625-D	N248484	Sash Lift	1/5/25	.115	2.29 PK
217250-C	N116558	Bb Sash Lift	1/5/30	.108	1.99 PK
217269-C	N116616	4" Nickel Sash Lift	1/5/30	.078	1.99 PK
242357-C	N164848	Ab Sash Lift	1/5/30	.109	1.99 PK

National Mfg.

Chest Handle - Made of cold rolled steel. Zinc finish. For smaller chests and boxes. V-pack. Available in 2 sizes: 2-3/4" and 3-1/2".



Product No.	Mfg. No.	Description	Order Mult.	Weight	Unit Cost
230359-D	N203760	2-3/4" Chest Handle	1/5/25	.260	2.79 PK
218213-C	N117002	3-1/2" Chest Handle	1/5/40	.431	3.29 PK

National Mfg.

Flush Door And Chest Handle - Manufactured of cold-rolled steel. For use on chests, trap doors, and by-passing doors where handle sets flush with surface. Can be used as a tie-down for trucks, moving vans, and animal trailers. Plate size: 4-1/4" x 5-1/4". Zinc finish. Packed 1 each in a visual pack with screws. Safe working load: 215 lb.



Product No.	Mfg. No.	Description	Order Mult.	Weight	Unit Cost
242470-C	N185975	Flush Chest Handle	1/5/25	.760	6.49 PK

National Mfg.

Flush Ring Pull - Manufactured of cold-rolled steel. For use on chests, trap doors, cellar doors, and by-passing doors where handle sets flush with surface. Plate size: 3" x 3-1/2". Zinc finish. Packed 1 each in a visual pack with screws. Safe working load: 100 lb.



Product No.	Mfg. No.	Description	Order Mult.	Weight	Unit Cost
230340-D	N203752	Flush Ring Pull	1/5/25	.360	4.79 PK

National Mfg.

Adjust-O-Matic Gate Latch - For swinging doors. Latches when bar strikes latch lever. Floating bar adjusts to compensate for gate sag. Bar guide has 2 pivot holes to right or left hand mounting on flush doors. Zinc or satin black finish. 4".



Product No.	Mfg. No.	Description	Order Mult.	Weight	Unit Cost
207136-C	N101253	4" Zinc Gate Latch	1/5/15	.639	4.49 PK
207145-C	N101220	4" Blk Gate Latch	1/0/15	.641	5.79 PK

National Mfg.

Automatic Gate Latch - For use on single-acting gates, swinging barn doors, and animal pens. Mount on post for inswinging action, gate for outswinging action. Latches automatically. Wrought steel. Available in zinc or satin black finishes. Visual packed with screws.



Product No.	Mfg. No.	Description	Order Mult.	Weight	Unit Cost
234883-C	N101162	Zinc Gate Latch	1/5/15	.513	3.49 PK
214728-C	N101121	Blk Gate Latch	1/0/5	.513	4.29 EA

National Mfg.

Adjust-O-Matic Heavy-Duty Gate Latch - Designed for heavier stockade-type gates where there is spacing between post and gate. Latches automatically when bar strikes latch lever. Floating crossbar adjusts to compensate for gate sag. Surface application. No mortising required. Steel with black painted finish. Visual packed with screws. Size: 8".



Product No.	Mfg. No.	Description	Order Mult.	Weight	Unit Cost
234892-C	N101394	8" Blk Gate Latch	1/5/10	1.906	15.79 PK

Tell Mfg. Inc.

4-1/2 x 4-1/2 Steel Plain Bearing Hinge - Full mortise, plain bearing, standard weight, standard template screw hole. 5 knuckle nonrising removable pin, button tip and plug. For use on low frequency doors in commercial buildings. Available in satin brass (US4), prime coat (USP), or satin chromium-plated (US26D) finish. 3 each per box.



Product No.	Mfg. No.	Description	Order Mult.	Weight	Unit Cost
236837-D	H45454/1279	Satin brass (US4) finish	1/0/5	3.400	15.79 BX
236810-D	H4545/1279	Prime coat (USP) finish	1/0/5	3.400	11.99 BX
236829-D	H454526/1279	Satin chromium-plated (US26D) finish	1/0/5	3.500	15.79 BX

Tell Mfg. Inc.

4-1/2 x 4-1/2 Steel Ball Bearing Hinge - Full mortise, ball bearing, standard weight, standard template screw holes. 5 knuckle, 2 ball bearings, nonrising removable pin button tip and plug. For use on average frequency doors in commercial buildings. Recommend using with a door closer. May be required in some code applications. Available in satin brass (US4), prime coat (USP), or satin chromium-plated (US26D) finish. 3 each per box.



Product No.	Mfg. No.	Description	Order Mult.	Weight	Unit Cost
236888-D	H4545BB4/BB1279	4-1/2" Steel Hinge	1/0/5	3.300	21.49 BX
236853-D	H4545BB/BB1279	4-1/2" Steel Hinge	1/0/5	3.300	17.79 BX
236861-D	H4545BB26/BB1279	4-1/2" Steel Hinge	1/0/5	3.300	19.79 BX

Tell Mfg. Inc.

4-1/2 x 4-1/2 NRP Solid Brass Ball Bearing Hinge, Satin Chromium- Plated - Full mortise, ball bearing, nonremovable pin, standard weight, standard template screw hole. The 5 knuckle, nonremovable pin has a small set screw in the body of the barrel. For use on average frequency doors in commercial buildings. For exterior doors. Won't rust. Satin chromium-plated (US26D) finish. 3 each per box.



Product No.	Mfg. No.	Description	Order Mult.	Weight	Unit Cost
236896-D	HV4545BB26NRP	4-1/2" Sb Hinge	1/0/5	.500	62.99 BX

Tell Mfg. Inc.

4-1/2 x 4-1/2 NRP Steel Ball Bearing Hinge, Satin Chromium- Plated - Full mortise, ball bearing, nonremovable pin, standard weight, standard template screw holes. The 5 knuckle, nonremovable pin has a small set screw in the body of the barrel. For use on doors with average frequency service in commercial buildings. For interior doors. Satin chromium-plated (US26D) finish. 3 each per box.



Product No.	Mfg. No.	Description	Order Mult.	Weight	Unit Cost
236918-D	H4545BB26NRP/BB1279	4-1/2" Steel Hinge	1/0/5	3.367	22.99 BX

National Mfg.

Full Mortise Residential Hinge - A genuine button-tip and nib (bottom plug) full mortise butt of standard design. Made of slightly lighter gauge steel than the model No. 500 series. Loose pin.



Product No.	Mfg. No.	Description	Order Mult.	Weight	Unit Cost
208572-C	N142604	3" x 3" satin brass, 1 pair per box	1/5/50	.725	3.29 PR
208581-C	N142794	3-1/2" x 3-1/2" satin brass, 1 pair per box	1/5/50	.960	3.29 PR
208590-C	N143040	4" x 4" satin brass, 1 pair per box	1/5/25	1.037	4.79 PR
246719-C	N190082	3-1/2" x 3-1/2" bright brass, 1 each per card	1/5/20	.525	6.29 EA
246689-C	N186908	3" x 3" satin brass, 1 pair per card	1/5/40	.725	3.99 PR

Continued Next Column

Continued From Previous Column

Product No.	Mfg. No.	Description	Order Mult.	Weight	Unit Cost
201506-C	N176628	3-1/2" x 3-1/2" satin brass, 1 pair per card	1/5/40	.850	3.99 CD
201392-C	N176644	4" x 4" satin brass, 1 each per card	1/5/40	.800	2.99 CD
201542-C	N176636	3-1/2" x 3-1/2" antique brass, 1 pair per card	1/5/30	.960	9.79 CD
201481-C	N176651	4" x 4" antique brass, 1 each per card	1/5/30	.616	5.49 CD
256420-C	N190108	4" x 4" bright brass, 1 each per card	1/5/20	.636	7.49 PK
256455-C	N240457	3-1/2" x 3-1/2" white, 1 each per card	1/5/20	.509	4.99 PK
256447-C	N240465	4" x 4" white, 1 each per card	1/5/20	.635	5.99 PK

National Mfg.

Security Stud Hinge - Satin brass finish. Door hinge is designed to provide security for outswinging exterior doors. Outswing doors are commonly found leading from the home to garage interior. Locking tab feature: Locking tab in 1 leaf of the hinge projects into hole in the other leaf to help prevent unwanted door removal when hinge pin is removed and door is in the closed position. Steel brasstone finish. Maximum door weight: 2 hinges equal 110 lb., 3 hinges equal 165 lb. 1 each per card.

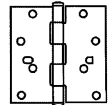

Product No.	Mfg. No.	Description	Order Mult.	Weight	Unit Cost
251887-C	N240259	4" Security Stud Hinge	1/5/30	.615	4.29 EA

National Mfg.

Full Mortise Residential Radius Corner Hinge - Standard design. Made of slightly lighter gauge steel than the model No. 500 Series. Loose pin. 1/4" radius round corners.



Product No.	Mfg. No.	Description	Order Mult.	Weight	Unit Cost
208670-C	N143966	3" satin brass finish, boxed	1/5/50	.720	3.29 PR
208689-C	N144352	3-1/2" satin brass finish, boxed	1/5/50	.888	3.29 PR
208698-C	N144832	4" satin brass finish, boxed	1/5/25	1.310	4.79 PR
235837-C	N144550	3-1/2" antique brass finish, boxed	1/10/50	.900	9.29 PR
246727-C	N190231	3-1/2" bright brass finish, visual carded	1/5/20	.500	6.29 EA
246735-C	N190249	4" bright brass finish, visual carded	1/5/20	.632	7.49 EA
246697-C	N186916	3-1/2" satin brass finish, visual carded	1/5/40	.913	3.99 PR
246700-C	N186932	4" satin brass finish, visual carded	1/5/40	.610	2.99 EA

National Mfg.

Residential Solid Brass Hinge - Square corner solid polished brass hinge is decorative and functional. Lacquer finish protects and beautifies. Brass screws included. 1 per card.



Product No.	Mfg. No.	Description	Order Mult.	Weight	Unit Cost
219533-D	N195685	3-1/2" x 3-1/2" square corner	1/0/5	.500	7.49 CD
219843-D	N195693	4" x 4" square corner	1/0/5	.600	9.29 CD

HINGES

HARDWARE

National Mfg.

Residential Solid Brass Radius Corner Hinge - Round corner solid polished brass hinge is decorative and functional. Lacquer finish protects and beautifies. Brass screws included. 1 each.



Product No.	Mfg. No.	Description	Order Mult.	Weight	Unit Cost
219819-D	N195701	3-1/2" x 3-1/2", 1/4" radius corner	1/0/5	.500	7.49 EA
206048-D	N207035	4" x 4", 5/8" radius corner	1/0/5	3.240	9.49 EA
219800-D	N195719	4" x 4", 1/4" radius corner	1/0/5	.600	9.29 EA
219835-D	N197756	3-1/2" x 3-1/2", 5/8" radius corner	1/0/5	.500	7.49 EA

Lawrence Brothers

Square Corner Hinge - For use on residential weight doors. Square corners, 5 knuckle reversible removable pin with screws. Yellow zinc (2D) finish. 1 pair per box 3-1/2" x 3-1/2".

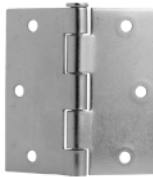

Product No.	Mfg. No.	Description	Order Mult.	Weight	Unit Cost
200990-D	125001502	2pk Square Corner Hinge	1/0/50	.800	2.29 PR

Lawrence Brothers

Round Corner Hinge - For use on residential weight doors. 5/8" radius round corners, 5 knuckle reversible removable pin with screws. Yellow zinc (2D) finish. 1 pair per box 3-1/2" x 3-1/2".



Product No.	Mfg. No.	Description	Order Mult.	Weight	Unit Cost
211951-D	125581502	2pk Round Corner Hinge	1/0/50	.820	2.29 PR

National Mfg.

Spring Hinge - Catalog model No. V521 series. Cold-rolled steel with brass finish. Designed for hanging self-closing doors in basements, stairways, garages, and entrances. Can be used in residential, commercial, and apartment buildings. Hinge is UL approved for fire doors. Closing speed is adjustable. Fits standard hinge cutout. 1/4" radius, round corner automatic door-closing spring hinge. 3-1/2" x 3-1/2". Packed 1 hinge per card with screws.



Product No.	Mfg. No.	Description	Order Mult.	Weight	Unit Cost
212077-D	N185-199	3-1/2" Spring Hinge	1/0/12	.718	13.49 PK

National Mfg.

Loose-Pin Broad Hinge - Catalog model No. 504 thru V504 series. Steel loose pin reversible broad butt. Oval head pin. Packed without screws. Plain steel finish.

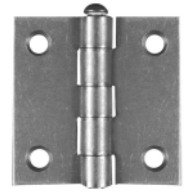

Product No.	Mfg. No.	Description	Order Mult.	Weight	Unit Cost
209170-D	N139659	2" Broad Hinge	10/0/100	.137	1.49 EA
209189-C	N139733	2-1/2" Broad Hinge	10/0/100	.213	1.79 EA
205637-C	N139808	3" Broad Hinge	10/0/100	.312	1.79 EA
205628-C	N139873	3-1/2" Broad Hinge	10/0/80	.524	2.29 EA
209198-D	N139998	4" Broad Hinge	5/0/50	.647	3.29 EA
246743-C	N195644	2-1/2" Zn Broad Hinge	1/5/25	.506	5.29 PR
246751-C	N195651	3" Zn Broad Hinge	1/5/25	.762	5.99 PR
246778-C	N195669	3-1/2" Zn Broad Hinge	1/5/25	1.157	6.99 PR
246786-C	N195677	4" Zn Broad Hinge	1/5/25	.731	4.49 EA

National Mfg.

Tight-Pin Broad Hinge - Catalog model No. 505 series. Steel tight pin broad butt for average weight doors. Packed without screws. Plain steel finish.

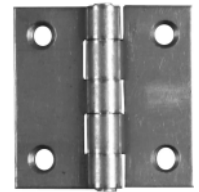

Product No.	Mfg. No.	Description	Order Mult.	Weight	Unit Cost
209205-D	N140368	2" Broad Hinge	10/0/100	.137	1.49 EA
209214-C	N140418	2-1/2" Broad Hinge	10/0/100	.188	1.79 EA
209223-C	N140467	3" Broad Hinge	10/0/100	.319	1.79 EA
209232-C	N140566	3-1/2" Broad Hinge	10/0/80	.518	2.29 EA
209241-D	N140681	4" Broad Hinge	5/0/50	.643	3.29 EA

National Mfg.

Loose-Pin Light Narrow Hinge - Catalog model No. 508 series. Loose pin, cold-rolled steel. 1 pair in visual pack with screws. Zinc and satin brass finish.



Product No.	Mfg. No.	Description	Order Mult.	Weight	Unit Cost
229309-C	N141606	1" Zinc Pin Hinge	1/5/50	.068	1.99 PK
229318-D	N141739	1-1/2" Zinc Pin Hinge	1/5/50	.111	2.29 PK
229327-C	N141838	2" Zinc Pin Hinge	1/5/50	.194	2.29 PK
229336-C	N141945	2-1/2" Zinc Pin Hinge	1/5/50	.257	2.79 PK
229345-C	N142034	3" Zinc Pin Hinge	1/5/50	.375	3.29 PK
229354-C	N141622	1" Sb Pin Hinge	1/5/50	.068	2.29 PK
229363-D	N141754	1-1/2" Sb Pin Hinge	1/5/50	.111	2.79 PK
229372-C	N141879	2" Sb Pin Hinge	1/5/50	.197	2.99 PK
229381-C	N141960	2-1/2" Sb Pin Hinge	1/5/50	.252	3.29 PK
229390-C	N142067	3" Sb Pin Hinge	1/5/50	.373	3.79 PK

HARDWARE

National Mfg.

Tight-Pin Light Narrow Hinge - Catalog model No. V518 series. Tight pin, cold-rolled steel. 1 pair in a visual pack with screws. Zinc and satin brass finish.

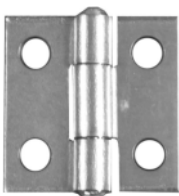

Product No.	Mfg. No.	Description	Order Mult.	Weight	Unit Cost
229407-C	N145920	1" Zinc Pin Hinge	1/5/50	.066	1.79 PK
229416-D	N146043	1-1/2" Zinc Pin Hinge	1/5/50	.100	1.99 PK
229425-C	N146159	2" Zinc Pin Hinge	1/5/50	.182	1.99 PK
229434-C	N146258	2-1/2" Zinc Pin Hinge	1/5/50	.241	2.29 PK
229443-C	N146373	3" Zinc Pin Hinge	1/5/50	.350	2.79 PK
209474-D	N145946	1" Brz Pin Hinge	1/5/50	.063	2.29 PK
209483-C	N146068	1-1/2" Brs Pin Hinge	1/5/50	.111	2.29 PK
209492-C	N146175	2" Brs Pin Hinge	1/5/50	.192	2.49 PK
209508-C	N146290	2-1/2" Brs Pin Hinge	1/5/50	.259	2.79 PK
209517-C	N146399	3" Brz Pin Hinge	1/5/50	.385	3.49 PK

Dimension chart		
Size	A	B
1"	1"	1"
1-1/2"	1-1/2"	1-13/32"
2"	2"	1-9/16"
2-1/2"	2-1/2"	1-11/16"
3"	3"	2"

National Mfg.

Half Surface Hinge - Cold-rolled steel beveled edges, narrow leaf. Made specially for use on all hollow core doors with jambs down to 1-1/8" thickness. Brass finish.



Product No.	Mfg. No.	Description	Order Mult.	Weight	Unit Cost
208947-C	N133306	3-1/2" half Surface Hinge	1/0/25	1.260	10.79 PK

National Mfg.

Heavy Full-Service Spring Hinge - 3" heavy steel full surface spring hinge. Strong, dependable spring, fully enclosed. Can be used on either right hand or left hand doors. Ideal for screen or combination doors and wood lavatory stall doors with wood partitions. Packed 2 hinges in a visual pack with screws. BakEnamel brass finish.



Product No.	Mfg. No.	Description	Order Mult.	Weight	Unit Cost
208368-C	N114785	3" Heavy Spring Hinge	1/2/10	1.087	14.49 PK

National Mfg.

Adjustable Full-Surface Spring Hinge - Catalog model No. V125 series. 3" cold-rolled steel, solid brass adjustable collar. Strong fully enclosed spring. For use on either right hand or left hand doors. Stud pin adjusts to provide desired closing speed. Full-surface application, no mortising required. Zinc, BakEnamel brass, or galvanized finish. Packed 1 pair in a visual pack with screws.



Product No.	Mfg. No.	Description	Order Mult.	Weight	Unit Cost
242446-C	N115055	3" Zinc Spring Hinge	1/2/10	1.150	14.49 PK
234794-C	N115006	3" Brass Spring Hinge	1/2/10	1.144	15.79 PK
256706-C	N115105	3" Galv Spring Hinge	1/2/10	1.020	25.99 PK

National Mfg.

Adjustable Half-Surface Spring Hinges - Has strong fully enclosed spring and can be used on either right hand or left hand doors. Solid brass collar has stud pin for adjusting spring tension. The butt leaf has width for 1-1/8" mortise and fits against the stop on jamb. Packed 2 hinges in a visual pack with screws. BakEnamel brass painted finish.



Product No.	Mfg. No.	Description	Order Mult.	Weight	Unit Cost
234785-C	N115147	Sb Half-surface Hinge	1/2/10	1.190	21.49 PK

National Mfg.

Satin Brass Hinge - Cold-rolled steel. Adjustable spring tension. For doors 3/4" thru 1-1/4". Satin brass finish. 3" size. Packed 2 hinges in a visual pack with screws.



Product No.	Mfg. No.	Description	Order Mult.	Weight	Unit Cost
208466-C	N115303	Brs Double-action Hinge	1/2/10	2.190	31.49 PK

National Mfg.

Spring Hinge - Catalog model No. V520 series. Steel, template, nonhanded single acting. Adjustable tension. Can be used to convert existing doors to self-closing. Listed for fire rated openings up to 3'0" to 7'0" x 1-3/4". Ideally suited for residential as well as commercial, industrial, and institutional uses. Pivot point aligns with standard butt hinges. Packed 1 hinge with adjusting pin and tension pin. UL listed. Available in 3-1/2" x 3-1/2" and 4" x 4". Satin brass finish. Packed 1 hinge per visual pack with screws.

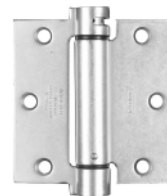

Product No.	Mfg. No.	Description	Order Mult.	Weight	Unit Cost
212423-C	N184556	3-1/2" Spring Hinge	2/0/12	.720	12.49 PK
212431-C	N184572	4" Brs Spring Hinge	2/0/12	.831	13.79 PK

HINGES

HARDWARE

National Mfg.

Hinge Pin Door Closer - Steel with a solid brass cover. Easily installed by replacing hinge pin with closer. Adjustable tension. Satin brass finish. Packed 1 each in a visual pack.



Product No.	Mfg. No.	Description	Order Mult.	Weight	Unit Cost
242489-C	N208033	Brs Hinge Pin Closer	1/5/25	.275	5.79 PK

National Mfg.

Strap Hinge - Catalog model No. 280, V280, 282, and V282 series. Zinc finish.

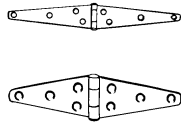

Product No.	Mfg. No.	Description	Order Mult.	Weight	Unit Cost
209606-D	N127357	2" light hinge, no screws	10/0/100	.053	.69 EA
209615-C	N127431	3" light hinge, no screws	10/0/100	.100	.79 EA
209624-C	N127506	4" light hinge, no screws	10/0/100	.131	.99 EA
209633-D	N127597	5" light hinge, no screws	10/0/100	.213	1.29 EA
209642-C	N127639	6" light hinge, no screws	10/0/100	.300	1.49 EA
209688-D	N127365	2" light hinge, steel pin, visual pack with screws	1/5/50	.144	2.29 PK
209697-C	N127449	3" light hinge, steel pin, visual pack with screws	1/5/50	.238	2.29 PK
209704-C	N127514	4" light hinge, steel pin, visual pack with screws	1/5/50	.338	3.29 PK
223519-C	N127605	5" light hinge, steel pin, visual pack with screws	1/5/50	.545	4.79 PK
209713-D	N127969	4" heavy hinge, no screws	10/0/100	.221	1.79 EA
209722-C	N128017	5" heavy hinge, no screws	10/0/80	.381	1.99 EA
209731-C	N128074	6" heavy hinge, no screws	10/0/60	.698	2.29 EA
256536-C	N128322	6" heavy strap hinge, hot-rolled steel, galvanized coating has solid brass pin	1/10/40	.710	5.79 EA
209740-C	N128157	8" heavy hinge, no screws	5/0/40	1.335	3.79 EA
209759-C	N127878	10" heavy hinge, no screws	1/5/30	.355	6.99 EA
209768-C	N127910	12" heavy hinge, no screws	1/5/15	3.300	13.49 EA
209777-C	N127977	6" heavy hinge, visual pack with screws, 1 pair per pack	1/5/30	.521	4.49 PK
209786-C	N128025	5" heavy hinge, visual pack with screws, 1 pair per pack	1/5/25	.873	6.29 PK
209795-C	N128082	6" heavy hinge, visual pack with screws, 1 pair per pack	1/5/25	1.602	7.79 PK
209802-C	N128165	8" heavy hinge, visual pack with screws, 1 pair per pack	1/0/5	2.925	12.49 PK

National Mfg.

Tee Hinge - Light T-hinges, zinc finish.

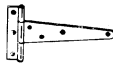

Product No.	Mfg. No.	Description	Order Mult.	Weight	Unit Cost
209964-D	N128421	2" without screws, each	10/0/100	.050	.69 EA
209973-C	N128504	3" without screws, each	10/0/100	.101	.79 EA
209982-C	N128579	4" without screws, each	10/0/100	.126	.99 EA
209991-D	N128645	5" without screws, each	10/0/100	.188	1.29 EA
210006-C	N128694	6" without screws, each	10/0/100	.261	1.49 EA
210033-C	N128439	2" visual pack with screws, 1 pair per pack	1/5/50	.155	2.29 PK
210042-C	N128512	3" visual pack with screws, 1 pair per pack	1/5/50	.273	2.49 PK

Continued Next Column

Continued From Previous Column

Product No.	Mfg. No.	Description	Order Mult.	Weight	Unit Cost
210051-D	N128587	4" visual pack with screws, 1 pair per pack	1/5/50	.342	3.29 PK
223500-C	N128652	5" visual pack with screws, 1 pair per pack	1/5/20	.475	4.79 PK
206351-D	N128702	6" visual pack with screws, 1 pair per pack	1/5/50	.625	6.29 PK

National Mfg.

Tee Hinge - Catalog model No. 286 thru V286. Extra heavy T-hinges, zinc, or galvanized finish.



Product No.	Mfg. No.	Description	Order Mult.	Weight	Unit Cost
210060-C	N129023	4" without screws, each	10/0/100	.327	1.99 EA
210079-C	N129072	5" without screws, each	10/0/80	.528	2.49 EA
210088-C	N129171	6" hot-rolled steel, galvanized coating without screws, each	10/0/60	.844	2.79 EA
256528-C	N129445	6", galvanized, with brass pin, each	1/10/30	.867	7.79 EA
210097-C	N129221	8" without screws, each	5/0/40	1.445	4.29 EA
210104-C	N128900	10" without screws, each	1/5/30	2.230	7.49 EA
210122-C	N129031	4" with screws, zinc-plated, 1 pair per pack	1/5/30	.600	5.49 PK
210131-C	N129080	5" with screws, zinc-plated, 1 pair per pack	1/5/25	1.250	8.29 PK
210140-C	N129189	6" with screws, zinc-plated, 1 pair per pack	1/5/25	1.950	8.49 PK
210159-C	N129239	8" with screws, zinc-plated, 1 pair per pack	1/5/15	3.175	12.99 PK

National Mfg.

Heavy-Duty Gate Hinge - Hot-rolled steel. Designed for applications with narrow mounting surfaces, such as gates, barn and shed doors, storage bins, and tool boxes. Tight pin allows right or left hand applications. For full or half surface applications. Size: 3-1/2" x 3-1/2". Boxed loose without screws.

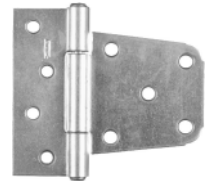

Product No.	Mfg. No.	Description	Order Mult.	Weight	Unit Cost
242322-C	N223875	Zinc-plated BakEnamel finish	10/0/40	.903	2.79 EA
242330-C	N223867	Satin black BakEnamel finish	10/0/40	.908	3.99 EA

HARDWARE

Some prices shown may vary due to market fluctuations, and are to be used as estimates.

National Mfg.

Continuous Hinge - Catalog model No. V570 series. For use on tool chests, cabinets, folding tables, and hobby projects. Can be cut to any desired length as friction pin will not fall out. Screw holes spaced 2" apart. Electroform-coated pin, .090 diameter, resists rust. Packed 1 unit to a visual pack with Phillips flat No. 4 x 1/2" screw. Gauge: .042. Steel.



Product No.	Mfg. No.	Description	Order Mult.	Weight	Unit Cost
206393-D	N265355	1-1/16" x 12" bright brass	1/0/5	2.342	4.99 EA
206360-D	N265371	1-1/16" x 12" nickel-plated	1/0/5	2.347	4.99 PK
209580-D	N148205	1-1/16" x 30" bright brass	1/0/3	.694	6.79 EA
209544-D	N148221	1-1/16" x 30" nickel-plated	1/0/3	.710	6.79 EA
224386-C	N148353	1-1/16" x 48" bright brass	1/0/3	1.073	9.29 EA
224368-C	N148379	1-1/16" x 48" nickel-plated	1/0/3	1.073	9.29 EA
224331-C	N148510	1-1/16" x 72" bright brass	1/0/3	1.672	12.49 EA
224233-C	N148536	1-1/16" x 72" nickel-plated	1/0/3	1.687	12.49 EA
206397-D	N265363	1-1/2" x 12" bright brass	1/0/5	2.854	5.29 EA
206388-D	N265389	1-1/2" x 12" nickel-plated	1/0/5	2.831	5.29 EA
224420-C	N148155	1-1/2" x 30" bright brass	1/0/3	.854	7.49 EA
224402-C	N148171	1-1/2" x 30" nickel-plated	1/0/3	.857	7.49 EA
224395-C	N148304	1-1/2" x 48" bright brass	1/0/3	1.334	9.99 EA
224377-C	N148320	1-1/2" x 48" nickel-plated	1/0/3	1.326	9.99 EA
224439-C	N148460	1-1/2" x 72" bright brass	1/0/3	2.093	13.79 EA
224411-C	N148486	1-1/2" x 72" nickel-plated	1/0/3	2.089	13.79 EA

National Mfg.

Steel Corner Irons - Catalog model No. 115 thru V115 series. Sizes up to 3-1/2" x 3/4" made of hot-rolled steel. Zinc-plated or bright brass.



Product No.	Mfg. No.	Description	Order Mult.	Weight	Unit Cost
206654-D	N275628	3/4" x 1/2" zinc finish, 4 per pack	1/5/25	.094	1.79 PK
210621-D	N266270	1" x 1-1/2", box packed no screws	40/0/480	.021	.29 EA
210630-C	N266304	1-1/2" x 5/8", box packed no screws	40/0/360	.048	.29 EA
210649-C	N266361	2" x 5/8", box packed no screws	40/0/400	.063	.39 EA
210658-C	N266338	2-1/2" x 5/8", box packed no screws	40/0/240	.096	.49 EA
210667-C	N266395	3" x 3/4", box packed no screws	40/0/240	.152	.59 EA
210676-C	N264200	3-1/2" x 3/4", box pack with bar code	10/0/100	.175	.79 EA
210685-D	N220145	4" x 7/8", box pack with bar code	10/0/100	.242	1.29 EA
210694-D	N220152	5" x 1", box pack with bar code	10/0/50	.395	1.79 EA
210701-C	N220160	6" x 1-1/8", box pack with bar code	10/0/50	.667	2.29 EA
210710-C	N220178	8" x 1-1/4", box pack with bar code	5/0/25	1.286	3.99 EA
210729-C	N220186	10" x 1-1/4" box pack with bar code	5/0/25	1.581	5.29 EA
210738-C	N113050	1" x 1/2", pack 4 in visual bag with screws	1/5/50	.057	1.49 PK
210747-C	N113134	1-1/2" x 5/8", pack 4 in visual bag with screws	1/5/50	.244	1.79 PK
210756-D	N113308	2" x 5/8", pack 4 in visual bag with screws	1/5/50	.313	2.49 PK
210765-C	N113233	2-1/2" x 5/8", packed 4 in visual bag w/screws	1/5/50	.450	2.49 PK
210774-C	N113456	3" x 3-1/4", packed 4 in visual bag with screws	1/5/25	.694	3.29 PK
210783-C	N113399	3-1/2" x 3/4", packed 4 in visual bag with screws	1/5/25	.804	4.29 PK
256773-D	N190819	1" x 1/2", bright brass packed 4 in visual bag with screws	1/5/25	.116	1.79 PK

Continued Next Column

Continued From Previous Column

Product No.	Mfg. No.	Description	Order Mult.	Weight	Unit Cost
256765-D	N190827	1-1/2" x 5/8", bright brass packed 4 in visual bag with screws	1/5/25	.245	2.29 PK
256757-C	N190835	2" x 5/8", bright brass packed 4 in visual bag with screws	1/5/25	.316	2.49 PK
206609-D	N190843	2-1/2" x 5/8" brass finish, 4 per pack	1/5/25	.968	2.99 PK
206627-D	N190850	3" x 3/4" brass finish, 4 per pack	1/5/25	.702	3.79 PK

National Mfg.

T Plates - Hot-rolled steel. Zinc-plated.



Product No.	Mfg. No.	Description	Order Mult.	Weight	Unit Cost
210809-C	N266429	3x3 Zinc T-plate	20/0/100	.037	.89 EA
210818-D	N266445	4x4 Zinc T-plate	20/0/200	.107	1.29 EA
210827-D	N113704	3x3 T-plate	1/5/100	.221	2.29 PK
210836-C	N113753	4x4 T-plate	1/5/40	.327	2.79 PK

National Mfg.

Corner Brace - Catalog model No. V113. Manufactured of steel, .042" thickness, with a rust-resistant, zinc-plated finish. Used for a wide variety of inside corner bracing - tables, chairs, workbenches, desks, and other furniture applications. Packed 4 in a V-pac with 16 Phillips head screws per pack. 1-1/2" x 3/4".



Product No.	Mfg. No.	Description	Order Mult.	Weight	Unit Cost
230367-D	N206920	1-1/2x3/4 Corner Brace	1/5/25	.160	1.99 PK

National Mfg.

Corner Brace - Catalog model No. V114 series. Squares and reinforces a corner. Steel with zinc-plating. 4 per pack.



Product No.	Mfg. No.	Description	Order Mult.	Weight	Unit Cost
246794-C	N245704	2x5/8 Corner Brace	1/5/20	.238	3.49 PK
246808-C	N245720	2-1/2x5/8 Corner Brace	1/5/20	.304	3.99 PK
246816-C	N245407	3x5/8 Corner Brace	1/5/20	.374	4.29 PK
246824-C	N245415	4x5/8 Corner Brace	1/5/20	.513	5.79 PK

CORNER BRACES

National Mfg.

Flat Corner Irons - Catalog model No. 117 thru V117 series.
Hot-rolled steel. Zinc or brass finish.

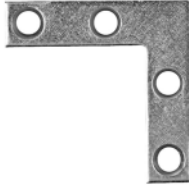

Product No.	Mfg. No.	Description	Order Mult.	Weight	Unit Cost
210845-C	N266460	1-1/2" x 3/8", box packed no screws, zinc-plated	40/0/200	.021	.29 EA
210854-C	N266486	2" x 3/8", box packed no screws, zinc-plated	40/0/200	.029	.29 EA
210863-C	N266502	2-1/2" x 1/2", box packed no screws, zinc-plated	40/0/200	.045	.39 EA
210872-D	N266528	3" x 1/2", box packed no screws, zinc-plated	40/0/200	.113	.49 EA
210881-D	N266544	3-1/2" x 5/8", box packed no screws, zinc-plated	20/0/100	.086	.59 EA
210890-C	N266569	4" x 3/4", box packed no screws, zinc-plated	20/0/100	.130	.59 EA
210907-C	N234955	5" x 7/8", box packed with bar code, zinc-plated	20/0/100	.166	.89 EA
210916-C	N234963	6" x 1", box packed with bar code, zinc-plated	20/0/200	.244	1.29 EA
218320-C	N113795	1-1/2" x 3/8", packed 4 in visual bag with screws, zinc-plated	1/5/25	.124	1.79 PK
210925-C	N113845	2" x 3/8", packed 4 in visual bag with screws, zinc-plated	1/5/25	.173	1.79 PK
210934-C	N113928	2-1/2" x 1/2", packed 4 in visual bag with screws, zinc-plated	1/5/25	.265	2.29 PK
210943-D	N113969	3" x 1/2", packed 4 in visual bag with screws, zinc-plated	1/5/25	.301	2.49 PK
210952-C	N114025	3-1/2" x 5/8", packed 4 in visual bag with screws, zinc-plated	1/5/40	.455	2.79 PK
234801-C	N114116	4" x 3/4", packed in 4 in visual bag with screws, zinc-plated	1/5/40	.612	3.29 PK
206663-D	N190868	1-1/2" x 3/8" brass finish, 4 per pack, brass finish	1/5/25	.114	2.29 PK
206672-D	N190876	2" x 3/8" brass finish, 4 per pack, brass finish	1/5/25	.148	2.29 PK
206681-D	N190884	2-1/2" x 1/2" brass finish, 4 per pack, brass finish	1/5/25	.235	2.79 PK

National Mfg.

Mending Brace - Catalog model No. 118 thru V118. Sizes up to 6" x 3/4" made of hot-rolled steel. Zinc-plated or brass finish.



Product No.	Mfg. No.	Description	Order Mult.	Weight	Unit Cost
210961-C	N272716	2" x 1/2", box packed no screws	40/0/200	.022	.29 EA
210970-D	N272724	3" x 5/8", box packed no screws	40/0/200	.048	.39 EA
210989-D	N272732	4" x 5/8", box packed no screws	20/0/100	.065	.49 EA
210998-C	N220285	6" x 3/4", box packed with bar code	5/0/25	.146	.79 EA
211005-C	N220293	8" x 7/8", box packed with bar code	5/0/25	.270	1.29 EA
211014-C	N220327	10" x 1", box pack with bar code	5/0/100	.424	1.79 EA
211023-D	N220335	12" x 1-1/8", box pack with bar code	5/0/50	.675	2.29 EA
211032-C	N114314	2" x 1/2", packed 4 in visual bag with screws	1/10/100	.119	1.79 PK
211041-D	N114355	3" x 5/8", packed 4 in visual bag with screws	1/10/100	.243	2.29 PK

Continued Next Column

HARDWARE

Continued From Previous Column

Product No.	Mfg. No.	Description	Order Mult.	Weight	Unit Cost
211050-C	N114405	4" x 5/8", packed 4 in visual bag with screws	1/5/30	.340	2.79 PK
206690-D	N190892	2" x 1/2" brass finish, 4 per pack	1/10/50	.117	2.29 PK
206707-D	N191007	3" x 5/8" brass finish, 4 per pack	1/10/50	.247	2.79 PK
206716-C	N191056	4" x 5/8" brass finish, 4 per pack	1/5/30	.332	2.99 PK

National Mfg.

Mending Plates - Manufactured of hot-rolled steel. Zinc-plated. Packed 4 each in a visual pack with screws.



Product No.	Mfg. No.	Description	Order Mult.	Weight	Unit Cost
242411-C	N220087	1-1/2x1-3/8 Mending Plate	1/5/25	.209	1.79 PK
256749-C	N220103	2-1/2" Sn Mending Plate	1/5/40	.335	2.29 PK

National Mfg.

Mail Slot - Gallery Series. Solid brass. Polished brass finish. Spring action lid seals out weather and dirt. Conforms to postal regulations Slot size: 7-1/32" x 1-15/16". Opening size: 7" x 1-1/2".



Product No.	Mfg. No.	Description	Order Mult.	Weight	Unit Cost
241660-C	N197913	1-1/2x7 Mail Slot	1/2/10	.739	21.49 EA

National Mfg.

Mail And Magazine Slot - Gallery Series. Solid brass. Polished brass finish. Spring action seals out weather and dirt. Conforms to postal regulations. Slot size: 11" x 2-5/16". Opening size: 11" x 2".



Product No.	Mfg. No.	Description	Order Mult.	Weight	Unit Cost
241717-C	N197905	2x11 Brs Mail Slot	1/2/10	1.529	31.49 EA

H. B. Ives

Mail Slot Sleeve - Stainless steel for 1-3/4" doors.



Product No.	Mfg. No.	Description	Order Mult.	Weight	Unit Cost
204585-C	C600	Use with mail slot model No. 626	1/0/15	.300	8.79 CD
204601-C	C601	Use with mail slot model No. 620	1/0/12	.717	11.99 CD

H. B. Ives

Mail Slot And Magazine - Artisan Series. Open back plate.



Product No.	Mfg. No.	Description	Order Mult.	Weight	Unit Cost
204610-C	C620B3	2" x 11" magazine slot, bright brass	1/0/2	1.650	41.49 CD
205147-C	CP620B-619	2" x 11" magazine slot, satin nickel	1/0/2	1.825	77.99 CD
204638-C	C626B3	1-1/2" x 7" mail slot, bright brass	1/0/2	1.150	26.49 CD
205138-C	CP626B-619	1-1/2" x 7" mail slot, satin nickel	1/0/2	3.325	57.99 CD

Baldwin Hdwe.

Letter Box Plate - Wrought brass. Catalog and small package size. Weather tight installation. Bronze spring keeps flap tightly closed and permits vertical installation. Wood screws included. Size overall: 13" x 3.625". Size opening: 11" x 2". The Lifetime Finish™.



Product No.	Mfg. No.	Description	Order Mult.	Weight	Unit Cost
213365-D	0012003	11x2 Letter Box Plate	0/0/1	2.000	72.99 EA

Baldwin Hdwe.

Letter Box Plate - Wrought brass. Catalog and small package size. Weather tight installation. Bronze spring keeps flap tightly closed and permits vertical installation. Hinging back plate provides additional privacy as well as decorative appearance. Wood screws included. Size overall: 13" x 3.625". Size opening: 11" x 2". The Lifetime Finish™.



Product No.	Mfg. No.	Description	Order Mult.	Weight	Unit Cost
213438-D	0014003	11x2 Letter Box Plate	0/0/1	2.500	114.99 EA

Baldwin Hdwe.

Letter Box Plate - Wrought brass. Magazine size. Weather-tight installation. Bronze spring keeps flap tightly closed and permits vertical installation. Wood screws included. Size overall: 10" x 3". Size opening: 7.5" x 2". The Lifetime Finish™.



Product No.	Mfg. No.	Description	Order Mult.	Weight	Unit Cost
213446-D	0015003	11x2 Letter Box Plate	0/0/1	1.200	89.99 EA

Baldwin Hdwe.

Letter Box Sleeve - Stainless steel. For 1.75" thick doors.



Product No.	Mfg. No.	Description	Order Mult.	Weight	Unit Cost
234400-D	0050-324	8.0625" L. x 2.25" W. x 1.6875" D., fits letter box plates model No. 0003, 0004, 0015, 0016, and 0017	0/0/1	.250	25.49 EA
234419-D	0052-324	11.375" L. x 2.75" W. x 1.6875" D., fits letter box plates model No. 0012, 0013, and 0014	0/0/1	.250	28.49 EA

National Mfg.

Door Knocker - Gallery Series. Solid brass. Polished brass finish. For doors up to 1-3/4" thick. Size: 7" x 3-5/8".



Product No.	Mfg. No.	Description	Order Mult.	Weight	Unit Cost
241709-C	N197939	7" Brs Door Knocker	1/2/10	.840	17.79 EA

National Mfg.

Door Knocker With Viewer - Gallery Series. Solid brass. Polished brass finish. For doors up to 2-1/4" thick. Includes 160° glass lens viewer for security. Viewer hole size: 1/2". Knocker size: 7" x 3-5/8".



Product No.	Mfg. No.	Description	Order Mult.	Weight	Unit Cost
241652-C	N215921	7" Door Knocker W/viewer	1/2/10	1.397	21.49 EA

National Mfg.

Door Knocker - Gallery Series. Solid brass. Polished brass finish. For doors up to 2" thick. Size: 6-1/2" x 1-29/32".



Product No.	Mfg. No.	Description	Order Mult.	Weight	Unit Cost
241695-C	N215947	6-1/2" Door Knocker	1/2/10	.572	13.49 EA

H. B. Ives

Door Knocker - Brass door knocker. Packaged with mounting hardware for door thickness up to 1-3/4". 6-7/16" L. x 2-15/16" W. C to C 4-7/8". Projection 15/16".



Product No.	Mfg. No.	Description	Order Mult.	Weight	Unit Cost
204424-C	C2-3102-605	Door Knocker	1/0/2	.800	25.99 EA

DOOR STOPS

HARDWARE

H. B. Ives

Door Knocker With Viewer - Artisan Series. Traditional design. Solid brass viewer body. Lifetime warranty. For 1-3/4" doors. UL listed.



Product No.	Mfg. No.	Description	Order Mult.	Weight	Unit Cost
200767-C	CP2-31252-619	Satin nickel (619) finish	1/0/5	.740	69.99 EA
219766-C	CP2-3125-613	Oil rubbed bronze (613) finish, without viewer	1/0/5	.640	57.99 EA
219971-C	CP2-3125-620	Antique pewter (620) finish, without viewer	1/0/5	.640	57.99 EA

H. B. Ives

Door Viewer - Wide angle lens. 190° viewing. For doors 1-3/8" to 2-1/8" thickness. Solid brass. Bright brass finish. UL listed.



Product No.	Mfg. No.	Description	Order Mult.	Weight	Unit Cost
204790-D	C698B3	Wide Angle Door Viewer	1/0/5	.120	13.49 CD

Baldwin Hdwe.

Door Viewer - Solid brass. Satin brass finish. Equipped with 3 metacrylate lenses to guarantee a clear and precise image. Exterior lens creates a field of vision exceeding 170°. Adjustable for door thickness from 1" to 2.5". .5" diameter quality lens.

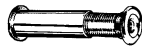

Product No.	Mfg. No.	Description	Order Mult.	Weight	Unit Cost
234435-D	0155-030	Door Viewer	1/0/10	.060	10.79 EA

Baldwin Hdwe.

Door Knocker - Solid brass. S style. For entrance doors. Proper fasteners included. Size: 7.75" x 2". CTC of bolts 5". The Lifetime Finish™.



Product No.	Mfg. No.	Description	Order Mult.	Weight	Unit Cost
213519-D	0113003	S Door Knocker	0/0/1	2.000	134.99 EA

National Mfg.

Wall Door Stop - Gallery Series. Solid brass. Polished brass finish. Gray rubber bumper. Diameter: 1-7/8". Projection: 1-1/8".



Product No.	Mfg. No.	Description	Order Mult.	Weight	Unit Cost
241547-C	N215855	Wall Door Stop	1/5/20	.159	3.49 EA

National Mfg.

Wall Door Stop With Large Base - Gallery Series. Solid brass. Polished brass finish. Gray rubber bumper. Diameter: 2-5/16". Projection: 1-1/8".



Product No.	Mfg. No.	Description	Order Mult.	Weight	Unit Cost
241601-C	N198069	Wall Door Stop	1/5/20	.182	3.49 EA

National Mfg.

Floor Door Stop - Gallery Series. Solid brass. Polished brass finish. Gray rubber bumper. For use on doors with 1/4" to 3/4" clearance. Diameter: 1-3/4". Height: 1-1/8".



Product No.	Mfg. No.	Description	Order Mult.	Weight	Unit Cost
241598-C	N198077	Satin Brs Flr Door Stop	1/5/15	.194	4.29 EA

National Mfg.

Kickdown Door Stop - Gallery Series. Solid brass. Polished brass finish. Gray nonmarring rubber tip. Length of arm: 4".



Product No.	Mfg. No.	Description	Order Mult.	Weight	Unit Cost
241571-C	N198085	4" Kickdown Door Stop	1/0/3	.422	10.79 EA

National Mfg.

Floor Door Stop - Gallery Series. Solid brass. Polished brass finish. Gray rubber bumper. For use on doors with up to 1" clearance. Height: 1-1/4".



Product No.	Mfg. No.	Description	Order Mult.	Weight	Unit Cost
241555-C	N215822	Floor Door Stop	1/5/25	.219	6.79 EA

HARDWARE

National Mfg.

High-Dome Floor Door Stop - Gallery Series. Solid brass. Polished brass finish. Gray rubber bumper. For use on doors with 1/2" to 1" clearance. Diameter: 1-11/16". Height: 1-3/8".



Product No.	Mfg. No.	Description	Order Mult.	Weight	Unit Cost
241563-C	N215806	Hi-dome Floor Stop	1/5/30	.248	3.99 EA

National Mfg.

Ball Catch - Gallery Series. Solid brass. Polished brass finish. For French doors, single doors, and cabinets. Ball is adjustable for door gap and latching tension. Size: 2-1/8" x 1-1/16".



Product No.	Mfg. No.	Description	Order Mult.	Weight	Unit Cost
241334-C	N216150	1x2-1/8 Ball Catch	1/5/20	.218	4.79 EA

National Mfg.

Handrail Bracket - Gallery Series. Solid brass. Bright brass finish. Base: 2-7/16" x 1-3/8". Base to center rail: 3-1/4". Safe working load: 200 lb. per bracket.



Product No.	Mfg. No.	Description	Order Mult.	Weight	Unit Cost
241326-C	N216168	Handrail Bracket	1/5/25	.465	7.29 EA

National Mfg.

Hook And Eye - Catalog model No. V2000 and 2000 series. Select visual pack or bulk box pack. Manufactured from steel with zinc finish.



Product No.	Mfg. No.	Description	Order Mult.	Weight	Unit Cost
206510-D	N117820	1", packed 2 per visual pack	10/0/50	.073	.89 PK
212521-D	N117853	1-1/2", packed 2 per visual pack	10/0/100	.063	.89 PK
212512-C	N117911	2", packed 2 per visual pack	10/0/100	.075	.89 PK
212503-C	N117952	2-1/2", packed 2 per visual pack	10/0/100	.113	.89 PK
212497-C	N117994	3", packed 2 per visual pack	10/0/100	.135	.89 PK
257028-D	N226373	4", packed 2 per visual pack	1/5/25	.124	1.29 PK
257036-C	N226381	6" packed 2 per visual pack	1/5/30	.206	1.49 PK
210550-E	N117846	1-1/2", box pack	100/0/200	.026	.29 EA
210569-D	N117903	2", box pack	50/0/200	.033	.29 EA
210578-C	N117945	2-1/2", box pack	50/0/100	.045	.29 EA
210587-D	N117986	3", box pack	50/0/100	.058	.39 EA
210596-D	N118026	4", box pack	50/0/100	.083	.49 EA
210603-C	N118042	6", box pack	10/0/50	.150	.89 EA

National Mfg.

Hook And Eye - Visual pack. Manufactured from solid brass with brass finish.



Product No.	Mfg. No.	Description	Order Mult.	Weight	Unit Cost
214701-D	N118083	1-1/2", 2 per pack	1/10/50	.070	2.29 PK
221432-D	N118133	2-1/2", 1 per pack	1/10/80	.073	1.79 PK

National Mfg.

Heavy Gate Hook With Staple - Visual pack or bulk box pack. Manufactured from steel with zinc finish. Sizes: 4", 5", and 6".



Product No.	Mfg. No.	Description	Order Mult.	Weight	Unit Cost
222841-D	N122168	4" Zn Gate Hook W/staple	1/5/30	.150	1.79 PK
242276-C	N122200	5" Zn Gate Hook W/staple	1/5/30	.264	1.79 PK
222850-C	N122242	6" Zn Gate Hook W/staple	1/5/30	.280	1.99 PK
210480-C	N122150	4" Gate Hook W/staple	10/0/50	.150	.99 EA
210499-C	N122192	5" Gate Hook W/staple	10/0/30	.250	1.29 EA
210505-D	N122234	6" Gate Hook W/staple	10/0/50	.256	1.49 EA

National Mfg.

Wire Staple - Manufactured from steel with zinc finish. Size: 2-1/2".



Product No.	Mfg. No.	Description	Order Mult.	Weight	Unit Cost
210523-E	N121947	Bulk	50/0/200	.030	.29 EA

National Mfg.

Heavy Safety Gate Hook - Visual pack. Plate staples included. Manufactured from steel with zinc finish. Size 6".



Product No.	Mfg. No.	Description	Order Mult.	Weight	Unit Cost
200160-C	N122622	6" Safety Gate Hook	1/5/25	.394	4.79 PK

National Mfg.

Heavy Safety Gate Hook - Visual pack with No. 2 screw eyes. Manufactured from steel with zinc finish. Size: 6".



Product No.	Mfg. No.	Description	Order Mult.	Weight	Unit Cost
223653-C	N122671	6" Safety Gate Hook	1/5/25	.380	4.49 PK

National Mfg.

Turnbuckle Gate Hook - Bulk box pack with 2 screw eyes. Hex shaped extruded aluminum body with zinc finish. Steel hooks and eyebolts. Size: 3/8" x 11".



Product No.	Mfg. No.	Description	Order Mult.	Weight	Unit Cost
203769-D	N222059	3/8x11zn Gate Turnbuckle	1/5/50	.570	5.49 EA

HOOKS

HARDWARE

National Mfg.

Small Screw Eye - Select visual pack or bulk box pack. Manufactured from steel with zinc finish.

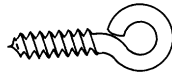

Product No.	Mfg. No.	Description	Order Mult.	Weight	Unit Cost
219052-C	N118190	#204 Eye Screw	10/0/50	.125	.79 PK
219061-C	N118224	#206 Zn Small Screw Eye	10/0/50	.100	.79 PK
219025-C	N118257	#208 Zn Small Screw Eye	10/0/50	.100	.79 PK
219043-C	N118430	#210 Zn Small Screw Eye	10/0/50	.075	.79 PK
219007-C	N118471	#212 Zn Small Screw Eye	10/0/50	.050	.79 PK
219016-C	N118281	#212-1/2 Zn Sm Screw Eye	10/0/50	.042	.79 PK
218981-C	N118513	#214 Zn Small Screw Eye	10/0/50	.031	.79 PK
212638-C	N118323	#214-1/2 Zn Sm Screw Eye	10/0/50	.025	.79 PK
212647-C	N118554	#216 Zn Small Screw Eye	10/0/50	.019	.79 PK
218990-C	N118356	#216-1/2 Zn Sm Screw Eye	10/0/50	.019	.79 PK
218963-C	N118398	#217-1/2 Zn Sm Screw Eye	10/0/50	.019	.79 PK
222002-D	N118240	#208 Bp Small Screw Eye	50/0/250	.012	.07 EA
223047-D	N118422	#210 Bp Small Screw Eye	50/0/250	.008	.05 EA
223056-D	N118463	#212 Bp Small Screw Eye	100/0/500	.002	.05 EA
223065-D	N118505	#214 Bp Small Screw Eye	100/0/500	.002	.05 EA
223074-B	N118547	#216 Bp Small Screw Eye	100/0/500	.001	.03 EA

ModelNo.	WireDia.	InsideEye Dia.	ThreadLgth.	OverallLgth.	Qty. Per Vis.Pack
204	.216	5/16"	15/16"	1-15/16"	4
206	.190	1/4"	3/4"	1-5/8"	5
208	.159	1/4"	5/8"	1-3/8"	6
210	.136	7/32"	1/2"	1-3/16"	8
212	.105	3/16"	7/16"	15/16"	10
212-1/2	.105	3/16"	1/4"	3/4"	10
214	.080	5/32"	5/16"	13/16"	10
214-1/2	.080	5/32"	3/16"	5/8"	14
216	.062	1/8"	9/32"	11/16"	14
216-1/2	.062	1/8"	3/16"	17/32"	14
217-1/2	.054	1/8"	5/32"	15/32"	14

National Mfg.

Medium Screw Eye - Select visual pack or bulk box pack. Manufactured from steel with zinc finish.



Product No.	Mfg. No.	Description	Order Mult.	Weight	Unit Cost
219089-C	N118794	#104 Zn Medium Screw Eye	10/0/50	.125	.79 PK
219098-C	N118828	#106 Zn Medium Screw Eye	10/0/50	.127	.79 PK
219070-C	N118869	#108 Zn Medium Screw Eye	10/0/50	.100	.79 PK
212601-C	N118893	#110 Zn Medium Screw Eye	10/0/50	.081	.79 PK
212610-C	N118927	#112 Zn Medium Screw Eye	10/0/50	.050	.79 PK
212629-C	N118968	#114 Zn Medium Screw Eye	10/0/50	.050	.79 PK
223564-D	N118851	#108 Bp Medium Screw Eye	50/0/250	.015	.09 EA
223573-D	N118885	#110 Bp Medium Screw Eye	50/0/250	.008	.05 EA
223582-D	N118919	#112 Bp Medium Screw Eye	100/0/500	.004	.05 EA
223591-B	N118950	#114 Bp Medium Screw Eye	100/0/500	.002	.03 EA

ModelNo.	WireDia.	InsideEye Dia.	ThreadLgth.	OverallLgth.	Qty. Per Vis.Pack
104	.216	1/2"	15/16"	2-1/16"	3
106	.190	7/16"	11/16"	1-3/4"	5
108	.159	3/8"	11/16"	1-1/2"	5
110	.136	5/16"	9/16"	1-5/16"	8
112	.105	9/32"	7/16"	1-1/8"	10
114	.080	1/4"	5/16"	15/16"	14

National Mfg.

Large Screw Eye - Select visual pack or bulk box pack. Manufactured from steel with zinc finish.



Product No.	Mfg. No.	Description	Order Mult.	Weight	Unit Cost
218909-C	N119198	#4 Zn Large Screw Eye	10/0/50	.138	.79 PK
212594-C	N119222	#6 Zn Large Screw Eye	10/0/50	.119	.79 PK
218936-C	N119263	#8 Zn Large Screw Eye	10/0/50	.100	.79 PK
218945-C	N119040	#10 Zn Large Screw Eye	10/0/50	.094	.79 PK
218918-C	N119081	#12 Zn Large Screw Eye	10/0/50	.067	.79 PK
218927-C	N119131	#12 Zn Large Screw Eye	10/0/50	.049	.79 PK
212148-D	N220418	#000 Zn Large Screw Eye	10/0/50	.200	.79 EA
212157-D	N220426	#0 Zn Large Screw Eye	20/0/100	.194	.49 EA
212166-C	N220434	#2 Zn Large Screw Eye	20/0/200	.069	.29 EA
223804-D	N119032	#10 Bp Large Screw Eye	50/0/250	.010	.07 EA
223813-D	N119073	#12 Bp Large Screw Eye	100/0/500	.006	.05 EA
223822-D	N119123	#14 Bp Large Screw Eye	100/0/500	.010	.05 EA

ModelNo.	WireDia.	InsideEye Dia.	ThreadLgth.	OverallLgth.	Qty. Per Vis.Pack
000	.361	1"	1-5/8"	3-7/8"	
0	.300	13/16"	1-1/4"	2-7/8"	
2	.262	23/32"	1-1/8"	2-5/8"	
4	.216	5/8"	15/16"	2-3/16"	3
6	.190	17/32"	3/4"	1-15/16"	4
8	.159	15/32"	11/16"	1-5/8"	6
10	.136	13/32"	1/2"	1-3/8"	8
12	.105	3/8"	7/16"	1-3/16"	10
14	.080	11/32"	5/16"	1-1/16"	12

National Mfg.

Large Screw Eye - Catalog model No. V2015 series. Visual pack. Manufactured from solid brass with brass finish.



Product No.	Mfg. No.	Description	Order Mult.	Weight	Unit Cost
222217-C	N119362	#8 Sb Large Screw Eye	10/0/40	.055	1.29 PK
242292-C	N119289	#10 Sb Large Screw Eye	10/0/50	.058	1.29 PK
214698-C	N119305	#12 Sb Large Screw Eye	10/0/100	.038	1.29 PK

ModelNo.	WireDia.	InsideEye Dia.	ThreadLgth.	OverallLgth.	Qty. Per Vis.Pack
8	.159	11/16"	1/2"	1-5/8"	3
10	.136	1/2"	3/16"	1-3/8"	4
12	.105	7/16"	3/8"	1-3/16"	5

HARDWARE

SCREWS/HOOKS

National Mfg.

Large Screw Eye - Catalog model No. 2016BC series. Bulk box pack. Manufactured from stainless steel - resists corrosion.



Product No.	Mfg. No.	Description	Order Mult.	Weight	Unit Cost
203815-D	N220442	#0 Ss Large Screw Eye	20/0/100	.010	1.49 EA
203823-E	N220459	#2 Ss Large Screw Eye	20/0/100	.068	1.29 EA
203947-D	N220467	#4 Ss Large Screw Eye	20/0/100	.038	.69 EA
203971-E	N220475	#8 Ss Large Screw Eye	20/0/100	.016	.49 EA

Model No.	Wire Dia.	Inside Eye Dia.	ThreadLgth.	OverallLgth.
0	.300	13/16"	1-1/4"	2-7/8"
2	.262	3/4"	1-1/8"	2-5/8"
4	.216	5/8"	15/16"	2-3/16"
8	.159	1/2"	11/16"	1-5/8"

National Mfg.

Square Bend Screw Hook - Catalog model No. V2030 and 2030 series. Select visual pack or bulk pack. Manufactured from steel with zinc finish.



Product No.	Mfg. No.	Description	Order Mult.	Weight	Unit Cost
223001-C	N120287	#104 Sq Bend Screw Hook	10/0/80	.100	.89 PK
222985-C	N120337	#106 Sq Bend Screw Hook	10/0/80	.094	.89 PK
212567-C	N120378	#108 Sq Bend Screw Hook	10/0/80	.081	.89 PK
212576-C	N120402	#110 Sq Bend Screw Hook	10/0/50	.068	.89 PK
212585-C	N120436	#112 Sq Bend Screw Hook	10/0/50	.038	.89 PK
223038-C	N120477	#114 Sq Bend Screw Hook	10/0/50	.025	.89 PK
231920-D	N120394	#110 Sq Bend Screw Hook	50/0/250	.009	.09 EA
231939-D	N120428	#112 Sq Bend Screw Hook	100/0/500	.005	.07 EA
231948-D	N120469	#114 Sq Bend Screw Hook	100/0/500	.002	.05 EA

Model No.	Wire Dia.	Thread Lgth.	HookEnd Lgth.	Overall Lgth.	Qty. Per Vis.Pack
104	.222	15/16"	1"	3-1/16"	2
106	.190	3/4"	7/8"	2-5/8"	3
108	.159	11/16"	3/4"	2-1/4"	5
110	.136	9/16"	5/8"	1-13/16"	6
112	.105	7/16"	1/2"	1-3/8"	10
114	.080	5/16"	3/8"	1"	12

National Mfg.

Tarp Or Rope Hook - 2053 manufactured from steel with zinc finish. Working load 100 lb.



Product No.	Mfg. No.	Description	Order Mult.	Weight	Unit Cost
206066-D	N220574	2" radius corner	1/20/100	.044	.59 EA
206067-E	N220582	3-1/2" radius corner	1/20/100	.127	.99 EA

National Mfg.

Light Closed S Hook - Select visual pack or bulk box pack. Manufactured from steel with zinc finish.



Product No.	Mfg. No.	Description	Order Mult.	Weight	Unit Cost
226516-C	N121277	#809 Light Closed S Hook	10/0/80	.088	.89 PK
227828-C	N121319	#810 Light Closed S Hook	10/0/100	.075	.89 PK
228952-C	N121350	#811 Light Closed S Hook	10/0/50	.069	.89 PK
229050-C	N121392	#812 Light Closed S Hook	10/0/50	.063	.89 PK
229078-C	N121434	#813 Light Closed S Hook	10/0/50	.044	.89 PK
213307-C	N121343	#811 Light Closed S Hook	50/0/200	.010	.09 EA
213325-D	N121384	#812 Light Closed S Hook	50/0/200	.008	.07 EA

Model No.	Wire Dia.	Inside Eye Dia.	Overall Lgth.	Qty. Per Vis. Pack
809	.146	3/4"	2-1/8"	3
810	.136	1/2"	1-5/8"	4
811	.122	3/8"	1-1/4"	5
812	.105	5/16"	1-1/8"	6
813	.092	1/4"	7/8"	8

National Mfg.

Heavy S Hook - Catalog model No. V2076 thru 2076 series. Select visual pack or bulk box pack. Manufactured from steel with zinc finish.



Product No.	Mfg. No.	Description	Order Mult.	Weight	Unit Cost
224288-C	N121533	3/4"zn Heavy Open S Hook	10/0/50	.025	.79 PK
224297-C	N121574	1" Zn Heavy Open S Hook	10/0/50	.038	.79 PK
224359-C	N121616	1-1/2" Heavy Open S Hook	10/0/50	.100	.99 PK
224536-C	N121665	2" Zn Heavy Open S Hook	10/0/50	.138	.99 PK
224625-C	N121715	2-1/2" Heavy Open S Hook	10/0/80	.113	.89 PK
242268-C	N121756	3" Zn Heavy Open S Hook	10/0/50	.006	.99 PK
213192-D	N121525	3/4" Heavy Open S Hook	50/0/500	.003	.07 EA
212200-D	N121566	1" Bp Heavy Open S Hook	50/0/200	.008	.09 EA
213218-D	N273425	2" Heavy Open S Hook	50/0/150	.066	.39 EA
213227-D	N273433	2-1/2" Heavy Open S Hook	50/0/100	.110	.49 EA
213245-D	N273441	3" Heavy Open S Hook	50/0/200	.149	.59 EA

Overall Lgth.	Wire Dia.	Inside Eye Dia.	Qty. Per Vis. Pack
3/4"	.080	7/32"	8
1"	.105	5/16"	6
1-1/2"	.177	7/16"	4
2"	.262	25/32"	2
2-1/2"	.300	7/16"	1
3"	.312	15/16"	1

National Mfg.

Heavy S Hook - Visual pack. Manufactured from solid brass with brass finish.



Product No.	Mfg. No.	Description	Order Mult.	Weight	Unit Cost
224643-C	N121780	3/4" Heavy Open S Hook	10/0/50	.013	.89 PK
224670-C	N121806	1" Sb Heavy Open S Hook	10/0/50	.025	.99 PK

Overall Lgth.	Wire Dia.	Inside Eye Dia.	Qty. Per Vis. Pack
3/4"	.080	7/32"	3
1"	.105	5/16"	3

SCREWS/HOOKS

HARDWARE

National Mfg.

Heavy S Hook - Catalog model No. 2078BC thru 2078 series. Bulk box pack. Manufactured from stainless steel. Resists corrosion.



Product No.	Mfg. No.	Description	Order Mult.	Weight	Unit Cost
205044-D	N233536	1-1/2" Ss Heavy S Hook	20/0/100	.003	.59 EA
205109-E	N233544	2" Ss Heavy S Hook	20/0/100	.007	1.29 EA
205133-E	N233551	2-1/2" Ss Heavy S Hook	20/0/60	.012	1.79 EA
205362-D	N233569	3" Ss Heavy S Hook	20/0/100	.015	1.99 EA

Overall Lgth.	Wire Dia.	Inside Eye Dia.
1-1/2"	.177	7/16"
2"	.262	9/16"
2-1/2"	.300	25/32"
3"	.312	15/16"

National Mfg.

Lag Screw Eye - Catalog model No. 2150BC series. Bulk box pack. Manufactured from steel with zinc finish.



Product No.	Mfg. No.	Description	Order Mult.	Weight	Unit Cost
205575-E	N220665	1/4x3-3/4 Lag Screw Eye	10/0/100	.075	.49 EA
205702-D	N220673	1/4x5 Lag Screw Eye	10/0/50	.088	.49 EA
206075-E	N220681	5/16x4 Lag Screw Eye	10/0/100	.113	.69 EA
206342-D	N220699	5/16x6 Lag Screw Eye	10/0/50	.150	.79 EA
206377-D	N220707	3/8x4-1/2 Lag Screw Eye	10/0/100	.200	.89 EA
206385-E	N220715	3/8x8 Lag Screw Eye	10/0/50	.300	1.29 EA
206776-E	N220723	7/16x5-1/4 Lag Screw Eye	10/0/50	.324	1.79 EA

Dia. Thread In.	Overall Lgth. In.	Thread Lgth. In.	Inside Dia. Eye In.
1/4	3-3/4	1-1/2	1/2
1/4	5	1-1/2	1/2
5/16	4	1-5/8	5/8
5/16	6	1-5/8	5/8
3/8	4-1/2	1-5/8	3/4
3/8	8	2-1/2	3/4
7/16	5-1/4	2-1/8	1

National Mfg.

Lag Screw Eye - Catalog model No. 2151BC series. Bulk box pack. Manufactured from stainless steel. Resists corrosion.



Product No.	Mfg. No.	Description	Order Mult.	Weight	Unit Cost
207144-E	N220772	1/4x3-3/4 Lag Screw Eye	10/0/50	.070	1.29 EA
207152-D	N220780	1/4x5 Ss Lag Screw Eye	10/0/50	.087	1.49 EA
207160-D	N220798	5/16x4 Ss Lag Screw Eye	10/0/50	.114	1.99 EA
207187-D	N220806	3/8x4-1/2 Lag Screw Eye	1/10/50	.183	2.99 EA

Dia. Thread In.	Overall Lgth. In.	Thread Lgth. In.	Inside Dia. Eye In.
1/4	3-3/4	1-1/2	1/2
1/4	5	1-1/2	1/2
5/16	4	1-5/8	5/8
3/8	4-1/2	1-5/8	3/4

National Mfg.

Screw Hook - Bulk box pack. Lag screw thread. Manufactured from stainless steel. Resists corrosion.



Product No.	Mfg. No.	Description	Order Mult.	Weight	Unit Cost
207195-D	N220814	1/4x4-1/4 Ss Screw Hook	1/10/50	.082	2.79 EA
207209-D	N220822	3/8x4-7/8 Ss Screw Hook	1/10/50	.206	4.79 EA

Dia. Thread In.	Overall Lgth. In.	Thread Lgth. In.	Inside Dia. Eye In.
1/4	4-1/4	1-1/2	1
3/8	4-7/8	1-5/8	1

National Mfg.

Screw Hook - Bulk box pack. Lag screw thread. Manufactured from steel with zinc finish.



Product No.	Mfg. No.	Description	Order Mult.	Weight	Unit Cost
231813-C	N220863	1/4x4-1/4 Screw Hook	10/0/100	.081	.69 EA
231822-C	N220871	5/16x4-1/2 Screw Hook	10/0/50	.125	.79 EA
231831-D	N220889	3/8x4-7/8 Screw Hook	10/0/100	.188	1.29 EA

Dia. Thread In.	Overall Lgth. In.	Thread Lgth. In.	Inside Dia. Eye In.
1/4	4-1/4	1-1/2	1
5/16	4-1/2	1-5/8	1
3/8	4-7/8	1-5/8	1

National Mfg.

Heavy-Duty Screw Hook - Bulk box pack. Lag screw thread. Manufactured from steel with zinc finish. Size: 3/8" x 4-1/2".



Product No.	Mfg. No.	Description	Order Mult.	Weight	Unit Cost
212914-C	N220830	3/8x4-1/2 Screw Hook	10/0/50	.175	1.29 EA

HARDWARE

SCREWS/HOOKS

National Mfg.

Eye Bolt - Catalog model No. 2160BC series. Bulk box pack. Machine screw threads with hex nut, assembled. Manufactured from steel with zinc finish.



Product No.	Mfg. No.	Description	Order Mult.	Weight	Unit Cost
207217-E	N221051	3/16x1-1/2 Zn Eye Bolt	20/0/500	.019	.39 EA
207233-E	N221069	3/16x2 Zn Eye Bolt	20/0/500	.019	.39 EA
207276-E	N221077	3/16x2-1/2 Zn Eye Bolt	20/0/500	.025	.39 EA
207284-E	N221085	1/4x2 Zn Eye Bolt	20/0/200	.041	.39 EA
207292-D	N221101	1/4x2-1/2 Zn Eye Bolt	20/0/200	.094	.39 EA
207306-E	N221119	1/4x3 Zn Eye Bolt	20/0/200	.050	.49 EA
207349-D	N221127	1/4x4 Zn Eye Bolt	20/0/200	.125	.49 EA
207357-E	N221135	1/4x5 Zn Eye Bolt	20/0/100	.075	.59 EA
207365-D	N221143	1/4x6 Zn Eye Bolt	20/0/100	.088	.59 EA
207438-D	N221218	5/16x3-1/4 Zn Eye Bolt	10/0/100	.094	.59 EA
207306-E	N221226	5/16x4 Zn Eye Bolt	10/0/100	.100	.69 EA
207861-D	N221234	5/16x5 Zn Eye Bolt	10/0/100	.119	.69 EA
207888-D	N221242	5/16x6 Zn Eye Bolt	10/0/100	.138	.79 EA
207896-E	N221267	3/8x4 Zn Eye Bolt	10/0/100	.175	.89 EA
207918-D	N221275	3/8x5 Zn Eye Bolt	10/0/100	.200	.89 EA
207926-E	N221283	3/8x6 Zn Eye Bolt	10/0/50	.213	.99 EA
208000-E	N221291	3/8x8 Zn Eye Bolt	10/0/100	.269	1.29 EA
208078-D	N221309	1/2x4 Zn Eye Bolt	10/0/50	.330	1.99 EA
208086-E	N221317	1/2x6 Zn Eye Bolt	10/0/50	.399	2.29 EA
208116-D	N221325	1/2x8 Zn Eye Bolt	1/10/50	.493	2.49 EA
208515-D	N221333	1/2x10 Zn Eye Bolt	1/10/50	.600	2.99 EA
208523-D	N221341	1/2x12 Zn Eye Bolt	1/10/50	.680	3.49 EA

Dia.	Thread In.	Overall Lgth. In.	Thread Size	Thread Lgth. In.	Inside Dia. Eye In.
3/16		1-1/2	10-24	1/2	1/2
3/16		2	10-24	1-1/4	1/2
3/16		2-1/2	10-24	1-1/4	1/2
1/4		2	1/4-20	7/8	9/16
1/4		2-1/2	1/4-20	1-1/8	9/16
1/4		3	1/4-20	1-3/4	9/16
1/4		4	1/4-20	2-3/4	9/16
1/4		5	1/4-20	3-1/4	9/16
1/4		6	1/4-20	3-1/4	9/16
5/16		3-1/4	5/16-18	1-3/4	3/4
5/16		4	5/16-18	2-3/4	3/4
5/16		5	5/16-18	3-1/4	3/4
5/16		6	5/16-18	3-1/4	3/4
3/8		4	3/8-16	2-1/8	1
3/8		5	3/8-16	3-1/8	1
3/8		6	3/8-16	3-1/4	1
3/8		8	3/8-16	3-1/4	1
1/2		4	1/2-13	1-3/4	1
1/2		6	1/2-13	3-3/4	1
1/2		8	1/2-13	3-3/4	1
1/2		10	1/2-13	3-3/4	1
1/2		12	1/2-13	3-3/4	1

National Mfg.

Eye Bolt - Catalog model No. 2161BC series. Bulk box pack. Machine screw threads with hex nut, assembled. Manufactured from stainless steel. Resists corrosion.



Product No.	Mfg. No.	Description	Order Mult.	Weight	Unit Cost
208558-D	N221556	3/16x1-1/2 Zn Eye Bolt	10/0/50	.002	.79 EA
208574-D	N221564	3/16x2 Zn Eye Bolt	10/0/50	.020	.79 EA
208612-E	N221572	1/4x2 Ss Eye Bolt	10/0/100	.020	1.29 EA
208965-E	N221580	1/4x2-1/2 Ss Eye Bolt	10/0/50	.005	1.29 EA
209007-D	N221598	1/4x3 Ss Eye Bolt	10/0/50	.006	1.29 EA
209015-D	N221606	1/4x4 Ss Eye Bolt	10/0/50	.007	1.49 EA
209023-D	N221614	5/16x3-1/4 Ss Eye Bolt	10/0/50	.010	1.79 EA
209031-D	N221622	5/16x4 Ss Eye Bolt	10/0/100	.108	1.99 EA
209066-E	N221630	5/16x5 Ss Eye Bolt	10/0/50	.013	2.29 EA
209074-D	N221648	3/8x4 Ss Eye Bolt	1/10/50	.108	2.79 EA
209082-D	N221655	3/8x5 Ss Eye Bolt	1/10/50	.020	2.99 EA
209090-D	N221663	3/8x6 Ss Eye Bolt	1/10/50	.022	3.29 EA
209368-D	N221671	3/8x8 Ss Eye Bolt	1/10/50	.027	3.49 EA

Dia.	Thread In.	Overall Lgth. In.	Thread Size	Thread Lgth. In.	Inside Dia. Eye In.
3/16		1-1/2	10-24	1/2	1/4
3/16		2	10-24	1-1/4	1/4
1/4		2	1/4-20	7/8	9/16
1/4		2-1/2	1/4-20	1-1/8	9/16
1/4		3	1/4-20	1-3/4	9/16
1/4		4	1/4-20	2-3/4	9/16
5/16		3-1/4	5/16-18	1-3/4	3/4
5/16		4	5/16-18	2-3/4	3/4
5/16		5	5/16-18	3-1/4	3/4
3/8		4	3/8-16	2-1/8	1
3/8		5	3/8-16	3-1/8	1
3/8		6	3/8-16	3-1/4	1
3/8		8	3/8-16	3-1/4	1

National Mfg.

Eye Bolt - Catalog model No. 3260BC series. Machine screw threads with hex nut assembled. Forged steel with galvanized finish for corrosion resistance.



Product No.	Mfg. No.	Description	Order Mult.	Weight	Unit Cost
246298-D	N245076	1/4x2 Eye Bolt	5/0/25	.066	3.29 EA
246301-D	N245084	1/4x4 Eye Bolt	5/0/25	.097	3.79 EA
246328-D	N245100	5/16x2-1/4 Eye Bolt	5/0/25	.111	3.79 EA
246336-D	N245126	3/8x2-1/2 Eye Bolt	5/0/25	.190	4.29 EA
246344-D	N245134	3/8x4-1/2 Eye Bolt	5/0/25	.255	4.79 EA
246352-D	N245142	3/8x6 Eye Bolt	3/0/24	.321	5.29 EA
246360-D	N245159	1/2x3-1/4 Eye Bolt	5/0/25	.431	5.79 EA
246379-D	N245167	1/2x6 Eye Bolt	3/0/24	.586	7.29 EA
246387-D	N245175	1/2x8 Eye Bolt	3/0/24	.723	9.29 EA
246395-D	N245183	1/2x10 Eye Bolt	3/0/24	.841	11.49 EA

Dimension Chart		
Size	Dim. A	Dim. B (Thread Lgth.)
1/4" x 2"	2"	1-1/2"
1/4" x 4"	4"	2-1/2"
5/16" x 2-1/4"	2-1/4"	1-1/2"
5/16" x 4-1/4"	4-1/4"	2-1/2"
3/8" x 2-1/2"	2-1/2"	1-1/2"
3/8" x 4-1/2"	4-1/2"	2-1/2"
3/8" x 6"	6"	2-1/2"
1/2" x 3-1/4"	3-1/4"	1-1/2"
1/2" x 6"	6"	3"
1/2" x 8"	8"	3"
1/2" x 10"	10"	3"

TURNBUCKLES

National Mfg.

Hook Bolt - Bulk box pack with 2 hex nuts, assembled. Manufactured from steel with zinc finish. Sizes: 5/16" x 5" and 3/8" x 7".



Product No.	Mfg. No.	Description	Order Mult.	Weight	Unit Cost
231341-C	N221689	5/16x5 Hook Bolt	10/0/100	.125	.89 EA
231350-C	N221697	3/8x7 Hook Bolt	10/0/50	.250	1.29 EA

National Mfg.

Turnbuckle - Catalog model No. 2170BC series. Eye and eye. Bulk box pack. Hex shaped body. Manufactured from aluminum with zinc finish. Steel eyes.



Product No.	Mfg. No.	Description	Order Mult.	Weight	Unit Cost
210374-D	N221721	3/16x5-1/2 Zn Turnbuckle	10/0/50	.050	.99 EA
210390-E	N221739	7/32x6-1/2 Zn Turnbuckle	10/0/50	.074	1.29 EA
210404-E	N221747	1/4x7-1/2 Zn Turnbuckle	10/0/100	.100	1.49 EA
210412-D	N221754	5/16x9 Zn Turnbuckle	10/0/100	.213	1.99 EA
211362-C	N221762	3/8x10-1/2 Zn Turnbuckle	1/0/30	.350	1.99 EA
211370-D	N221770	3/8x16 Zn Turnbuckle	1/0/45	.488	4.29 EA
211400-D	N221788	1/2x17 Zn Turnbuckle	1/0/25	.948	9.79 EA

Dia. Thread In.	Overall Lgth. Open	Thread Size	Maximum Open In.	Minimum Closed In.	Body Lgth. In.	Inside Dia. Eye In.	Safe Working Load Lb.
3/16	x 5-1/2	10-24	6	4	2-1/4	9/32	45
7/32	x 6-1/2	12-24	6-1/4	4-1/2	2-3/4	11/32	55
1/4	x 7-1/2	1/4-20	7-3/4	5-3/16	3	3/8	90
5/16	x 9	5/16-18	9-1/4	6-1/4	3-3/4	1/2	130
3/8	x 10-1/2	3/8-16	11	7-1/2	4-1/4	5/8	215
3/8	x 16	3/8-16	16-1/2	10-1/4	7-1/8	5/8	215
1/2	x 17	1/2-13	18-3/8	11-7/8	7-1/4	3/4	320

National Mfg.

Turnbuckle - Catalog model No. 2172BC series. Hook and eye. Bulk box pack. Hex shaped body. Manufactured from aluminum with zinc finish. Steel hook and eye.

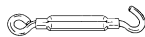

Product No.	Mfg. No.	Description	Order Mult.	Weight	Unit Cost
211435-D	N221846	3/16x5-1/2 Zn Turnbuckle	10/0/50	.050	.99 EA
211451-E	N221853	7/32x6-1/2 Zn Turnbuckle	10/0/50	.074	1.29 EA
211478-E	N221861	1/4x7-1/2 Zn Turnbuckle	10/0/100	.100	1.49 EA
211486-D	N221879	5/16x9 Zn Turnbuckle	10/0/100	.200	1.79 EA
211494-D	N221887	3/8x10-1/2 Zn Turnbuckle	1/0/25	.338	2.49 EA
211745-D	N221895	3/8x16 Zn Turnbuckle	1/0/45	.450	4.29 EA
211753-D	N221903	1/2x17 Zn Turnbuckle	1/0/25	.900	9.79 EA

Dia. Thread In.	Overall Lgth. Open	Thread Size	Minimum Open In.	Minimum Closed In.	Body Lgth. In.	Inside Dia. Eye In.	Safe Working Load Lb.
3/16	x 5-1/2	10-24	5-7/8	4	2-1/4	9/32	45
7/32	x 6-1/2	12-24	6-13/16	4-1/2	2-3/4	11/32	55
1/4	x 7-1/2	1/4-20	7-5/8	5-3/16	3	3/8	90
5/16	x 9	5/16-18	9-3/8	6-1/4	3-3/4	1/2	130
3/8	x 10-1/2	3/8-16	11-1/4	7-1/2	4-1/4	5/8	215
3/8	x 16	3/8-16	16-1/2	10-1/4	7-1/8	5/8	215
1/2	x 17	1/2-13	18-1/4	11-13/16	7-1/4	3/4	320

HARDWARE

National Mfg.

U Bolt - Catalog model No. 2190BC series. Bulk box pack with plate and 2 hex nuts, assembled. Manufactured from steel with zinc finish.



Product No.	Mfg. No.	Description	Order Mult.	Weight	Unit Cost
211834-D	N222075	#112 Zn U-bolt	10/0/200	.094	.79 EA
211842-D	N222083	#132 Zn U-bolt	10/0/200	.100	.79 EA
211850-D	N222109	#136 Zn U-bolt	10/0/200	.125	.99 EA
211869-E	N222117	#146 Zn U-bolt	10/0/200	.138	1.29 EA
211907-E	N222125	#512 Zn U-bolt	10/0/200	.144	1.29 EA
211966-E	N222133	#516 Zn U-bolt	10/0/200	.188	1.29 EA
211974-E	N222141	#522 Zn U-bolt	10/0/200	.181	1.29 EA
211982-E	N222158	#526 Zn U-bolt	10/0/200	.272	1.29 EA
211990-E	N222166	#532 Zn U-bolt	10/0/200	.191	1.29 EA
212032-D	N222174	#536 Zn U-bolt	10/0/200	.238	1.29 EA
212083-E	N222182	#542 Zn U-bolt	10/0/200	.213	1.29 EA
212105-E	N222562	#546 Zn U-bolt	10/0/180	.269	1.49 EA
212113-D	N222224	#662 Zn U-bolt	10/0/50	.490	1.99 EA

Model No.	Dia. Thread	Size Width Between Legs	Overall Lgth.	Thread Size	Thread Lgth.	Pipe Size*
112	1/4"	x 3/4"	x 2-1/2"	1/4-20	1-1/2"	3/8"
132	1/4"	x 1-1/8"	x 2-1/4"	1/4-20	1"	1/2" 3/4"
136	1/4"	x 1-1/8"	x 3-1/2"	1/4-20	1-3/4"	1/2" 3/4"
146	1/4"	x 1-3/8"	x 4"	1/4-20	2-3/8"	1"
512	5/16"	x 1-3/8"	x 2-1/2"	5/16-18	1-1/8"	1"
516	5/16"	x 1-3/8"	x 3-3/4"	5/16-18	2-1/4"	1"
522	5/16"	x 1-3/4"	x 3"	5/16-18	1-3/8"	1-1/4"
526	5/16"	x 1-3/4"	x 4-1/4"	5/16-18	2-1/4"	1-1/4"
532	5/16"	x 2"	x 3-1/4"	5/16-18	1-1/2"	1-1/2"
536	5/16"	x 2"	x 4-1/2"	5/16-18	2-1/2"	1-1/2"
542	5/16"	x 2-1/2"	x 3-1/2"	5/16-18	1-3/4"	2"
546	5/16"	x 2-1/2"	x 5"	5/16-18	2-1/4"	2"
662	3/8"	x 3-1/2"	x 5-1/4"	3/8-16	2-1/2"	3"

National Mfg.

U Bolt Plate - Bulk box pack. For use with model No. 2192 square U bolts. Manufactured from steel with zinc finish.



Product No.	Mfg. No.	Description	Order Mult.	Weight	Unit Cost
215058-E	N222323	To be used with 5/16" x 2" square U bolts	10/0/50	.050	.49 EA
215090-E	N222331	To be used with 3/8" x 3" square U bolts	10/0/50	.132	.79 EA
216232-D	N222349	To be used with 3/8" x 4" square U bolts	10/0/50	.152	.99 EA

National Mfg.

Square U Bolt - Bulk box pack with 2 hex nuts, assembled. Plates are separate, see the model No. 2191 series. Manufactured from steel with zinc finish.



Product No.	Mfg. No.	Description	Order Mult.	Weight	Unit Cost
216240-E	N222356	533, 5/16" diameter bolt; 2" W. x 3" L.	10/0/50	.130	1.29 EA
216259-D	N222364	535, 5/16" diameter bolt; 2" W. x 5" L.	10/0/50	.196	1.29 EA
216275-D	N222372	657, 3/8" diameter bolt; 3" W. x 7" L.	10/0/50	.476	2.49 EA
216291-D	N222380	637, 3/8" diameter bolt; 4" W. x 3" L.	10/0/30	.184	1.79 EA
216313-E	N222398	675, 3/8" diameter bolt; 4" W. x 5" L.	10/0/30	.400	2.29 EA
216585-E	N222406	677, 3/8" diameter bolt; 4" W. x 7" L.	10/0/30	.490	2.79 EA

H. B. Ives

Heavy-Duty Magnetic Catch - Aluminum case. Dual double pole. Self-aligning magnets insure maximum pull. Can be mounted or mortised. Case size 3-1/8" x 1" x 9/16".



Product No.	Mfg. No.	Description	Order Mult.	Weight	Unit Cost
208949-C	SP326A3	Bright brass	1/0/15	.287	4.79 BG
208957-C	SP326A92	Aluminum, natural	1/0/15	.287	4.29 BG

H. B. Ives

Heavy-Duty Roller Catch - Burnished wrought steel. Smooth positive latching action insured by powerful conical spring. Durable nylon roller insures quiet operation. Full lip style strike designed for simplified mortising. Face plate: 2-1/4" x 7/8". Bore: 3/4" x 1-3/4". Strike: 2-1/4" x 1-5/8". Lip: 1-3/16" to center.



Product No.	Mfg. No.	Description	Order Mult.	Weight	Unit Cost
208930-C	SP335F3	Roller Catch	1/0/15	.167	5.29 BG

H. B. Ives

Adjustable Ball Catch - Polished wrought brass. Free rolling ball ensures smooth, positive, and trouble-free action. Face plate: 1-1/2" x 3/4". Bore: 9/16" x 7/8". Strike: 1-1/2" x 25/32".



Product No.	Mfg. No.	Description	Order Mult.	Weight	Unit Cost
208884-C	SP345B3	Ball Catch	1/0/15	.113	4.99 BG

Liberty Hardware Mfg

Table Leg Support - May also be used on chest, shelves, cabinets, etc. Opens to 9-5/8" distance between centers. Arm width is 1/2" and gauge is .060. Brass-plated steel.



Product No.	Mfg. No.	Description	Order Mult.	Weight	Unit Cost
214565-D	L1083XC	Left hand	1/0/5	.263	1.99 CD
215546-D	R1083XC	Right hand	1/0/5	.263	1.99 CD

Liberty Hardware Mfg

Adjustable Friction Lid Support - For use on the lid of chests, boxes, cabinets, or anywhere a hold-open feature is desired. Spring loaded nylon washer maintains friction adjustment with use of standard screwdriver. Curved arm provides more uniform support than straight arm style. Heavy lids may require more than 1 support. Length of slot: 4-7/8". Brass-plated steel.



Product No.	Mfg. No.	Description	Order Mult.	Weight	Unit Cost
215617-D	L1086XC	Left hand	1/0/5	.150	2.99 CD
215644-D	R1086XC	Right hand	1/0/5	.150	2.99 CD



Outlet Plugs - Helps to protect children from electrical shock. Easy-to-install. Color: White.



Product No.	Mfg. No.	Description	Order Mult.	Weight	Unit Cost
226041-D	300	12 per card	1/0/5	.125	1.49 CD
245038-D	302	24 per card	1/0/5	.200	2.79 CD

Johnson Prod.

Sliding Door Hardware - For 3/4" or 1-3/8" doors up to 50 lb. Track is precision rolled heavy steel with convex rails. Hangers are heavy-gauge steel with zinc plating, and in reverse positions will accommodate both 3/4" or 1-3/8" doors. Wheels are 7/8" diameter molded from nylon and machined for size, smoothness and balance. Adjustable door guide is woodtone finished steel with woodtone nylon floating guides. Pulls are 3/4" diameter, brass-plated. 2 door kit.

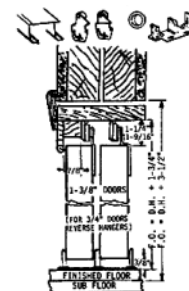

Product No.	Mfg. No.	Description	Order Mult.	Weight	Unit Cost
217535-D	1166G482	Opening size 48"	1/0/5	2.500	12.49 EA
218393-D	1166G602	Opening size 60"	1/0/5	3.000	14.49 EA
217170-D	1166G722	Opening size 72"	1/0/5	3.500	16.49 EA

DOOR HARDWARE

HARDWARE

Johnson Prod.

Sliding Door Hardware - For 3/4" or 1-3/8" doors up to 50 lb. Track is heavy extruded aluminum with convex rails. Hangers are heavy-gauge steel with zinc plating, and in reverse positions will accommodate both 3/4" or 1-3/8" doors. Wheels are 7/8" diameter, molded from nylon and machined for size, smoothness and balance. Adjustable door guide is woodtone finished steel with woodtone nylon floating guides. Pulls are 3/4" diameter, brass-plated. 2 door kit.

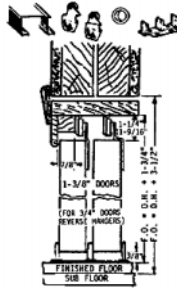

Product No.	Mfg. No.	Description	Order Mult.	Weight	Unit Cost
218375-D	2200482D	Opening size 48"	1/0/5	1.900	14.49 EA
218259-D	2200602D	Opening size 60"	1/0/5	2.200	16.49 EA
218222-D	2200722D	Opening size 72"	1/0/5	2.500	19.99 EA

Johnson Prod.

Folding Door Hardware - For 1" to 1-3/8" doors up to 35 lb. A most unique folding door hardware set that features top hung hardware, *breathing* shock absorber hinges, surface mounted hardware. Surface mounted pivot-guide components are ideal for the consumer because no hole drilling is required. *Breathing* shock absorber hinges prevent shock of fast opening or closing from deforming pivots, guides, and hinges. Top hung hardware allows door to hang naturally, reducing possible warpage. Automatic top door spacing eliminates unsightly gaps, permanently. Floating, soft action-trouble free from top to bottom. Steel woodtone finish track and brass colored parts blend perfectly with stained or natural wood doors.

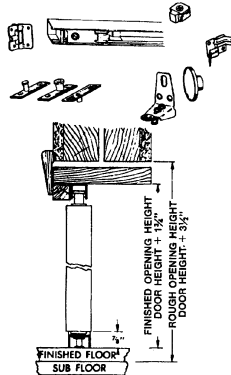

Product No.	Mfg. No.	Description	Order Mult.	Weight	Unit Cost
215895-D	1700363H	Opening size 36", 2 door kit	1/0/5	2.000	14.49 EA
215065-D	1700486H	Opening size 48", 4 door kit	1/0/5	3.200	24.49 EA
215029-D	1700606H	Opening size 60", 4 door kit	1/0/5	3.500	25.99 EA
215001-D	1700726H	Opening size 72", 4 door kit	1/0/5	3.900	26.99 EA

Johnson Prod.

Pocket Door Hardware - Heavy-duty commercial grade for 1-3/8" or 1-3/4" doors up to 125 lb. Track is heavy extruded aluminum with convex rails. Tricycle hangers (model No. 1120PPK1) provide smooth rolling action and will not derail. Includes track, 2 hangers, 2 guides, and rubber bumper. (Refer to the 2000 Department for replacement kit for replacement hardware.) Track length: 72" (for one 3' 0" door).

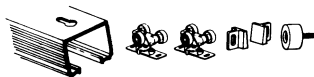

Product No.	Mfg. No.	Description	Order Mult.	Weight	Unit Cost
243051-D	100721DR	72" Door Track Set	1/0/5	3.200	27.49 SET

Johnson Prod.

Pocket Door Frame - Heavy-duty commercial grade pocket door frame for 1-3/8" or 1-3/4" doors up to 125 lb. Easily assembled, designed for the consumer. Includes: Tricycle hangers, providing smooth rolling action; jump proof, removable track; stiffeners; self-adjusting floor anchors and stops. Standard 6' 8" height. For 2" x 4" wood stud walls. Finished opening width 3' 0". Marked for cutting to any shorter width opening.



Product No.	Mfg. No.	Description	Order Mult.	Weight	Unit Cost
218473-D	153068PF	Pocket Door Set	0/0/1	30.000	82.99 EA

Johnson Prod.

Pocket Door Hardware Set - For model No. 1500 Series pocket frame and model No. 2711 Series pocket frame equipped with 100 track. Set contains: 2 model No. 1120 tricycle hangers with 1" diameter wheels, 2 model No. 1550 door guides, 1 model No. 1513 door bumper, 1 model No. 1712 wrench, and screws. Visual pack.

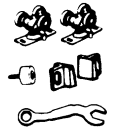

Product No.	Mfg. No.	Description	Order Mult.	Weight	Unit Cost
202584-D	1500PPK3	Pocket Door Hardware Set	1/0/10	.500	10.49 EA

Johnson Prod.

Privacy Lock - For 1-3/8" doors. Will fit a standard 2-3/8" backset, 2-1/8" bore, 15/16" diameter bore for latch bolt. Automatic latching when shut, touch-of-a-push-button locking with emergency release. Will latch converging doors together. Bright brass finish.

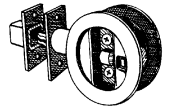

Product No.	Mfg. No.	Description	Order Mult.	Weight	Unit Cost
243027-D	15213PK1	Brass Privacy Lock	1/0/5	.500	17.49 EA

Johnson Prod.

Extra Offset Hanger Bypassing Hardware - For use with model No. 2200, 2200F, and 2222 Series bypassing hardware. 1 pair per visual bag.



Product No.	Mfg. No.	Description	Order Mult.	Weight	Unit Cost
216867-C	2216PPK2	1/16" offset	1/0/10	.250	2.99 PR
217036-D	2238PPK2	3/8" offset	1/0/10	.500	3.29 PR

Johnson Prod.

Universal Door Hanger - 2-wheel, 7/8" diameter V type track hanger for pocket door frames. Adjustable to fit most. 1 each per pack.



Product No.	Mfg. No.	Description	Order Mult.	Weight	Unit Cost
243019-D	2312PPK1	Universal Hanger	1/0/10	.300	4.99 EA

Johnson Prod.

Universal Replacement Hangers - For sliding doors. 1 pair per visual pack.

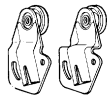

Product No.	Mfg. No.	Description	Order Mult.	Weight	Unit Cost
206288-D	2336PPK2	3/4" V wheel; 1/16" offset hanger	1/0/10	.250	3.29 PR
206261-D	2338PPK2	3/4" V wheel; 3/8" offset hanger	1/0/10	.250	3.29 PR
206245-D	2376PPK2	7/8" V wheel; 1/16" offset hanger	1/0/10	.250	3.29 PR
206237-D	2378PPK2	7/8" V wheel; 3/8" offset hanger	1/0/10	.250	3.29 PR

Johnson Prod.

Universal Pivot Set - Contains bottom pivot and jamb bracket for bi-fold doors. 1 set per visual pack.

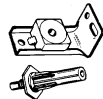

Product No.	Mfg. No.	Description	Order Mult.	Weight	Unit Cost
206318-D	1817PPK3	Universal Bottom Pivot	1/0/10	.250	2.29 PK

Johnson Prod.

Universal Top Guide - Top guide/pivot set for bi-fold doors. Fits most manufacturers' hardware. 1 set per visual pack.

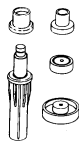

Product No.	Mfg. No.	Description	Order Mult.	Weight	Unit Cost
206296-D	1832PPK3	Universal Top Guide	1/0/10	.150	3.29 PK

Johnson Prod.

Universal Snubber - Replacement stop for all *tap-in* type bi-fold door hardware sets. 1 set per pack.



Product No.	Mfg. No.	Description	Order Mult.	Weight	Unit Cost
243043-D	1833PPK3	Universal Snubber	1/0/10	.080	1.79 PK

Johnson Prod.

Door Stop - Makes bypassing doors more convenient and easier to control. Limits sliding action, prevents pinched fingers. Molded nylon with rubber bumper.



Product No.	Mfg. No.	Description	Order Mult.	Weight	Unit Cost
217107-D	2155PPK1	Nylon Door Stop	1/0/10	.080	2.29 EA

Johnson Prod.

Adjustable Door Guide - Adjustment for 3/4" to 1-3/8" doors. Widths adjust by turning outside guides. Slots in plate key door face adjustment plumb. Visual pack. Brown tone finish.

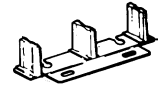

Product No.	Mfg. No.	Description	Order Mult.	Weight	Unit Cost
223305-D	2135PPK1	Door Guide	1/0/10	.120	1.99 EA

Johnson Prod.

Carpet Riser - For sliding doors. For use with the model No. 2135 door guide when door opening is carpeted. Eliminates need to cut hole in carpet. Made from steel with zinc-dichromate finish. 1-1/4" x No. 8 screws included.



Product No.	Mfg. No.	Description	Order Mult.	Weight	Unit Cost
218491-D	2136PPK1	Carpet Riser	1/0/10	.025	1.99 EA

Johnson Prod.

Guide/Riser Set - For use with 3/4" or 1-3/8" bi-pass doors. Set contains: 1 model No. 2135PPK1 guide, 1 model No. 2136PPK1 carpet riser. 1 set per visual pack.



Product No.	Mfg. No.	Description	Order Mult.	Weight	Unit Cost
206326-D	2156PPK3	Guide/riser Set	1/0/10	.320	2.79 PK

Johnson Prod.

Riser - For folding doors.



Product No.	Mfg. No.	Description	Order Mult.	Weight	Unit Cost
212377-D	1836PPK1	Folding Door Riser	1/0/10	.141	2.29 EA

Johnson Prod.

Aligner - For 4 folding doors.



Product No.	Mfg. No.	Description	Order Mult.	Weight	Unit Cost
212385-D	1808PPK1	4-door Folding Aligner	1/0/10	.109	1.99 EA

Johnson Prod.

Spring Hinge - Spring loaded, provides shock absorbing action when doors are opened or shut sharply. Allows for door warpage which can cause binding. Self-locating fingers automatically space doors. Eliminates stress on other door parts, track, pivot, guides, hinges. Packed 1 pair per visual pack.



Product No.	Mfg. No.	Description	Order Mult.	Weight	Unit Cost
206229-D	1703PPK2	Spring Hinge	1/0/10	.320	3.29 PR

DOOR HARDWARE

HARDWARE

Johnson Prod.

Flat Back Hinge - Hinge spacing fingers provide automatic alignment to doors, and eliminates *over-folding* problems. Smooth, non-binding operation is assured. Packed 1 pair per visual pack.



Product No.	Mfg. No.	Description	Order Mult.	Weight	Unit Cost
206210-D	1805PPK2	Dull Brass Hinge	1/0/10	.240	3.29 PR

Johnson Prod.

Edge Pull - For pocket doors. Bright brass finish.



Product No.	Mfg. No.	Description	Order Mult.	Weight	Unit Cost
212393-D	150-3PK1	Brass Edge Pull	1/0/10	.138	4.49 EA

Johnson Prod.

Rectangular Flush Pull - 1-3/8" x 3-1/8". Brass. Visual pack. 2 per pack.



Product No.	Mfg. No.	Description	Order Mult.	Weight	Unit Cost
223289-D	40-3PPK2	1-3/8x3-3/8 Flush Pull	1/0/10	.170	4.29 PR

Johnson Prod.

Suncrest Pocket Door Pull - Dummy lock. 2-1/8" diameter. Brass. Visual pack. 2 per pack.



Product No.	Mfg. No.	Description	Order Mult.	Weight	Unit Cost
223476-D	21-3PPK2	Brass Dummy Lock	1/0/10	.250	6.29 PR

Johnson Prod.

Sliding Door Pull - Oval pull. 1-3/8" x 3". Brass. Visual pack. 2 per pack.



Product No.	Mfg. No.	Description	Order Mult.	Weight	Unit Cost
223662-D	35-3PPK2	2" Brass Oval Pull	1/0/10	.170	4.29 PR

H. B. Ives

Sliding Door Pull - Artisan Series. Fabricated from the finest architectural brass. Decorative coined edges add structural support. Pre-assembled for left or right handed doors.



Product No.	Mfg. No.	Description	Order Mult.	Weight	Unit Cost
200829-C	CP990B-619	Satin nickel (619) finish	1/0/5	.480	8.29 EA
219748-C	CP990B-613	Oil rubbed bronze (613) finish	1/0/5	.480	8.29 EA
219944-C	CP990B-620	Antique pewter (620) finish	1/0/5	.480	8.29 EA

H. B. Ives

Sliding Door Lock - Artisan Series. Fabricated from the finest architectural brass. Decorative coined edges add structural support. Pre-assembled for left or right handed doors.



Product No.	Mfg. No.	Description	Order Mult.	Weight	Unit Cost
200838-C	CP991B-619	Satin nickel (619) finish	1/0/5	.540	11.49 EA
219757-C	CP991B-613	Oil rubbed bronze (613) finish	1/0/5	.480	11.49 EA
219953-C	CP991B-620	Antique pewter (620) finish	1/0/5	.480	11.49 EA

H. B. Ives

Flush Pull - Artisan Series. Solid brass flush pull. Size: 15/16" x 3-1/8". Satin nickel finish. 1-5/18" x 3-1/8".



Product No.	Mfg. No.	Description	Order Mult.	Weight	Unit Cost
200847-C	CP22B-619	Sn Flush Pull	1/0/5	.200	5.99 EA

Baldwin Hdwe.

Edge Pull - Solid forged brass. Polished brass finish. Spring loaded, returns lever flush with face plate. Recommended for pocket door. Wood screws included. Size: .75" x 1.625" x 3.875".



Product No.	Mfg. No.	Description	Order Mult.	Weight	Unit Cost
223220-D	0465-030	Edge Pull	1/0/10	.120	10.79 EA

Baldwin Hdwe.

Flush Ring Pull - Solid forged brass. Polished brass finish. Strong and durable. Wood screws included. Plate size: 1.625" x 1.625".



Product No.	Mfg. No.	Description	Order Mult.	Weight	Unit Cost
234273-D	0393-030	1.625" Flush Ring Pull	1/0/10	.100	18.79 EA

Baldwin Hdwe.

Sash Lock - Solid brass. Polished brass finish. Traditional style. Heavy-duty spring provides tension for a nonrattling fit. Necessary fasteners included. Latch base: .968" x 2.437". Strike base: .656" x 2.437".

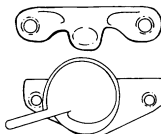

Product No.	Mfg. No.	Description	Order Mult.	Weight	Unit Cost
222984-D	0452-030	Sash Lock	1/0/10	.216	12.79 EA

Yale Security

Commercial Door Closer - Nonhanded, ANSI Grade 2, UL listed closer. Installs regular arm, parallel arm, or top jamb. No cover. 2 valves control speeds, sweep, and latching. Adjustable backcheck to provide cushion to the opening speed at 70° of the opening cycle. Finish: Silver (aluminum) bronze (SB). 5 year warranty.



Product No.	Mfg. No.	Description	Order Mult.	Weight	Unit Cost
244090-D	5103BCXSB/ 1521AL	Door Closer	1/0/8	3.500	119.99 EA

Tell Mfg. Inc.

Door Closer - Nonhanded, for use on right and left hand swing doors. Can be installed on regular, top jamb, or parallel arm. Adjustable for sizes 1 through 4 and capable of compliance with 5 lb. interior door and 8.5 lb. exterior door barrier-free opening force restrictions. ADA approved, UL listed. Adjustable hydraulic back check. Can be use for retrofit of Norton 1600 Series (size 4,5,6) and Yale 50 (size 4,5,6). Aluminum finish. For doors up to 36".



Product No.	Mfg. No.	Description	Order Mult.	Weight	Unit Cost
211001-D	12641PAAL	Alum Door Closer	1/0/4	6.000	94.99 EA

Yale Security

Commercial Door Closer - Standard duty door closer for use on interior and exterior doors. Nonhanded for use on right and left swing doors. 3 regular arm mountings: Pull side, push side, and above door. For doors hung on pivots or hinges. Separate regulation of main speed and latch speed. Satin aluminum finish (689). Adjustable back check cushioning to absorb the shock of the door beginning at 70°. Fits doors up to 3' 6". 2 year warranty.



Product No.	Mfg. No.	Description	Order Mult.	Weight	Unit Cost
244074-D	2004BCX689	Door Closer	1/0/8	6.670	74.99 EA

Yale Security

50 Series Door Closer - For high frequency interior or exterior doors which could be subject to abuse. Nonhanded. *Tri-Pack* installation. Packed with brackets for regular arm (RA), top jamb (TJ) or parallel arm (PA) installation. Adjustable closing and latch speeds. Rack and pinion operation. UL listed. Now with back check feature (BC): A valve controlled function that slows the door when it's being opened, from 70° to the fully open position so that the door will not damage adjacent walls or hardware. Sizing Chart for installations listed below. Closer is nonhold open. 10 year warranty.

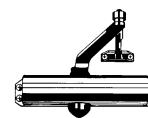

Product No.	Mfg. No.	Description	Order Mult.	Weight	Unit Cost
207216-D	V53BCX689	Satin aluminum finish (689), size: Interior up to 3'2" door, exterior up to 2'10" door	1/0/6	6.375	139.99 EA
204237-D	V53BCX691	Dull satin bronze (691), size: Interior up to 3'2" door, exterior up to 2'10" door	1/0/6	5.833	139.99 EA
213136-D	V54BCX689	Satin aluminum finish (689), size: Interior up to 4'2" door, exterior up to 3'6" door	1/0/6	1.167	139.99 EA
213152-D	V54BCX691	Dull satin bronze (691), size: Interior up to 4'2" door, exterior up to 3'6" door	1/0/6	6.900	139.99 EA
213144-D	V54BCX690	Dark statuary bronze (690), size: Interior up to 4'2" door, exterior up to 3'6" door	1/0/6	1.167	139.99 EA

Yale Security

51BF Series Barrier Free Door Closer - For high frequency interior or exterior doors which could be subject to abuse. Nonhanded. *Tri-Pack* installation. Packed with brackets for regular arm (RA), top jamb (TJ), or parallel arm (PA) installation. Adjustable for sizes 1 through 4 for use on interior doors requiring less than 5 lb. of opening force and for use on exterior doors up to 42". Complies with handicapped code requirements such as the Americans With Disabilities Act (A.D.A.). ANSI grade 1 closer. Rack and pinion operation. UL listed. Silver bronze (SB) finish. Power adjustment chart for installations. (Meters in parentheses). 10 year warranty.



Product No.	Mfg. No.	Description	Order Mult.	Weight	Unit Cost
238961-D	V51BFX689	Door Closer	1/0/6	6.383	149.99 EA

Yale Security

150 Series Door Closer With Hold-Open Arm - For high frequency interior or exterior doors which could be subject to abuse. Nonhanded. *Tri-Pack* installation. Packed with brackets for regular arm (RA), top jamb (TJ), or parallel arm (PA) installation. Adjustable closing and latch speeds. Rack and pinion operation. UL listed. Hold-open arm can be templated and adjusted for 90° to 180° hold-open. Now with back check feature (BC): A valve controlled function that slows the door when it's being opened, from 70° to the fully open position so that the door will not damage adjacent walls or hardware. Sizing chart for installations listed below. 10 year warranty.

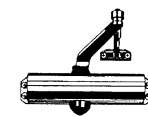

Product No.	Mfg. No.	Description	Order Mult.	Weight	Unit Cost
238937-D	V153BCX689	Satin aluminum finish (689), size: Interior up to 3'2" door, exterior up to 2'10" door	1/0/6	9.000	169.99 EA
238953-D	V154BCX689	Satin aluminum finish (689), size: Interior up to 4'0" door, exterior up to 3'6" door	1/0/6	9.000	169.99 EA
238945-D	V154BCX691	Dull satin bronze (691), size: Interior up to 4'0" door, exterior up to 3'6" door	1/0/6	9.000	169.99 EA

CLOSERS

Yale Security

3500 Series Door Closer - For interior and exterior doors where a full cover is required to fulfill aesthetic needs. Nonhanded. Multi-size normal power range adjustment, size 2 thru 6. Adjustable closing and latch speeds. Adjustable backcheck cushioning. *Tri-packed* installation: packed with appropriate arm and bracket for regular arm (RA) or top jamb (TJ) mounting for moderate reveals and soffit bracket for moderate reveals and soffit bracket for parallel arm (PA) mounting. UL listed. Available in satin aluminum (689) finish. Federal Spec. Type - FF-H-121C: 3001-3004-3009-3230 (MOD). Federal Spec. Type - FF-H-121D, ANSI type A156.4-1980: C02000 W/O PT 4A-4B-4C-4D-4H. Closer is nonhold open.



Product No.	Mfg. No.	Description	Order Mult.	Weight	Unit Cost
213101-D	3501X689	Door Closer	1/0/4	1.813	179.99 EA

Yale Security

2300 Series Door Closer - Economy closer for use on both exterior and interior doors in commercial and industrial applications. Available sizes are 3 or 4 and is bi-packed for regular arm (RA) or top jamb (TJ) installation. Closer is adaptable to parallel arm (PA) installation when parallel bracket model No. 289ASB is also selected. Closer is nonhold open, UL listed and nonhanded. Now with back check feature (BC): A valve controlled function that slows the door when it's being opened, from 70° to the fully open position so that the door will not damage adjacent walls or hardware. Back check is included on closer. 5 year limited warranty.



Product No.	Mfg. No.	Description	Order Mult.	Weight	Unit Cost
213047-D	V2303BCX689	Satin aluminum finish (689), size: Interior up to 3'4" door, exterior up to 2'10" door	1/0/6	6.667	89.99 EA
213055-D	V2303BCX690	Dark statuary bronze (690), size: Interior up to 3'4" door, exterior up to 2'10" door	1/0/6	6.600	89.99 EA
213063-D	V2304BCX689	Satin aluminum finish (689), size: Interior up to 4'0" door, exterior up to 3'4" door	1/0/6	6.250	89.99 EA
213071-D	V2304BCX690	Dark statuary bronze (690), size: Interior up to 4'0" door, exterior up to 3'4" door	1/0/6	6.000	89.99 EA

Yale Security

Parallel Bracket - For nonhold-open model No. 2300 Series door closer. Finish is silver bronze (SB), (aluminum) and includes mounting hardware.

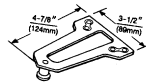

Product No.	Mfg. No.	Description	Order Mult.	Weight	Unit Cost
204530-D	289AX689	Parallel Bracket	1/12/60	.133	12.49 EA

Tell Mfg. Inc.

Residential Door Closers - UL listed for fire doors or with automatic hold-open feature. Compact-lightweight automatic door closer designed for home use. Adjustable door closing speeds. Mounts at top of door requiring hand tools only. Reversible for either right or left hand doors. Made of rugged die-cast and may be painted to match any decor. For inswinging and outswinging doors. For inswinging, mount to the outside of the door. For outswinging, mount to the inside of the door.



Product No.	Mfg. No.	Description	Order Mult.	Weight	Unit Cost
206172-D	10175	UL listed, brown	1/0/5	3.300	38.99 EA

Continued Next Column

Some products shown may need to be special ordered for your convenience!

HARDWARE

Continued From Previous Column

Product No.	Mfg. No.	Description	Order Mult.	Weight	Unit Cost
206180-D	10173	UL listed, ivory	1/0/5	3.300	38.99 EA
206199-D	11184	Hold-open, brown	1/0/5	3.300	38.99 EA
206202-D	11186	Hold-open, ivory	1/0/5	3.300	38.99 EA

Tell Mfg. Inc.

Light Commercial Door Closer - UL listed for fire doors or with automatic hold-open feature. For homes with heavy doors and for frequently used office doors. Closing speed and latching speed closes heavy door and doors with tight seals. Mounts at top of door requiring hand tool only. Made of rugged die-cast and can be painted. Can be mounted on either side of the door. Standard mount or top-jamb mount. Grade 3.

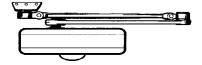

Product No.	Mfg. No.	Description	Order Mult.	Weight	Unit Cost
210633-D	20375/ DM103ULB	UL listed, brown	1/5/10	3.300	54.99 EA
210625-D	20373/ DM103ULI	UL listed, ivory	1/5/10	3.300	54.99 EA
210668-D	20675/ DM103HOB	Hold-open, brown	1/5/10	3.300	54.99 EA
210641-D	20673/ DM103HOI	Hold-open, ivory	1/5/10	3.300	54.99 EA

Tell Mfg. Inc.

Heavy-Duty Hydraulic Door Closer - UL listed nonhold-open for use on fire doors. For commercial and industrial sites. Designed for most demanding commercial applications. Handles doors up to 176 lb. Size 4. Made of cast aluminum and features an adjustable backcheck shock absorber, for less stress and longer life. Hydraulic fluid provides constant lubrication, for use in any climate. Adjustable closing and latching speeds means extra adaptability. Can be mounted in 3 different ways, standard, parallel arm, and top jamb, so it works with virtually any door design. BMHA certified grade 1. Can be used for retrofit of Norton 1600 Series (size 4, 5, 6) and Yale 50 (size 4, 5, 6). Color: Bronze, includes parallel bracket.

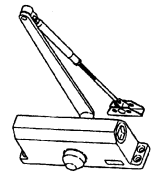

Product No.	Mfg. No.	Description	Order Mult.	Weight	Unit Cost
214523-D	15644PA DURA	Brz H/duty Door Closer	1/0/4	6.383	82.99 EA

National Mfg.

Round Rail - Plain round rail. Galvanized finish. 600 lb. capacity with 24" OC brackets.



Product No.	Mfg. No.	Description	Order Mult.	Weight	Unit Cost
708036-B	5400-8	8'	0/0/1	52.000	25.49 BX
708043-B	5400-10	10'	0/0/1	66.000	31.99 BX
708067-B	5400-12	12'	0/0/1	79.000	37.99 BX

HARDWARE

HARDWARE

PUSH PLATES

National Mfg.

Round Rail Bracket - Loose packaged. Galvanized finish. With lags. Single bracket.



Product No.	Mfg. No.	Description	Order Mult.	Weight	Unit Cost
708203-C	DP5410B	Packaged loose with lags	1/0/10	.750	4.29 EA
708241-C	5414BC	Boxed loose with lags	1/0/10	2.500	14.49 EA

National Mfg.

Round Rail Bracket - Loose packaged. Single splice bracket. Galvanized finish. With lags.



Product No.	Mfg. No.	Description	Order Mult.	Weight	Unit Cost
708227-C	DP5411B	Galv Round Rail Bracket	1/0/10	.800	6.49 EA

National Mfg.

Round Rail Bracket - Boxed loose. Galvanized finish. Double round rail splice bracket. Adjustable. With lags.



Product No.	Mfg. No.	Description	Order Mult.	Weight	Unit Cost
708258-B	5415BC	Galv Round Rail Bracket	1/0/10	2.650	19.79 EA

National Mfg.

Tab-Loc Round Hanger - 600 lb. capacity per pair. Boxed flexible with 1/2" offset bolt. 7-1/2" bolt. Zinc-plated.



Product No.	Mfg. No.	Description	Order Mult.	Weight	Unit Cost
708272-C	5310	Tab-loc Round Hanger	1/0/5	2.800	41.49 EA

National Mfg.

Flexible Hanger - Round rail hanger has 600 lb. capacity. Delrin wheels, roller bearings. Zinc-plated. Comes 1 pair boxed.



Product No.	Mfg. No.	Description	Order Mult.	Weight	Unit Cost
708289-B	5330	Flexible Hanger	1/0/5	4.700	52.99 EA

Tell Mfg. Inc.

Push Plate - Protection at door edge for opening. Countersunk holes. 3-1/2" x 15". Baked on clear lacquer finish. 6 x 5/8" screws included. Available in aluminum (US28) finish. Carded.



Product No.	Mfg. No.	Description	Order Mult.	Weight	Unit Cost
204549-C	P351528	3-1/2x15 Alum Push Plate	1/0/10	1.000	5.99 EA

Tell Mfg. Inc.

Push Plate - Visual packaged. 3-1/2" x 15" plate. Baked on clear lacquer finish. All necessary hardware is included. Satin stainless steel (US32D) finish. Pegable.



Product No.	Mfg. No.	Description	Order Mult.	Weight	Unit Cost
230677-D	P351532/70B	3-1/2x15 Ss Push Plate	1/0/5	1.000	7.29 EA

Tell Mfg. Inc.

Push Plate - 3-1/2" x 15" x .050". Countersunk holes. Baked on clear lacquer finish. 6 x 5/8" screws included. Carded, bright brass (US3) finish.

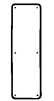

Product No.	Mfg. No.	Description	Order Mult.	Weight	Unit Cost
204951-C	P35153/C70B-3	3-1/2x15 Bb Push Plate	1/0/10	1.000	7.29 EA

H. B. Ives

Push Plate - 3-1/2" x 15". Solid brass. Bright brass finish.



Product No.	Mfg. No.	Description	Order Mult.	Weight	Unit Cost
204647-C	C8200B3	3-1/2x15 Brs Push Plate	1/0/5	.920	12.49 CD

DOOR PLATES

HARDWARE

H. B. Ives

Pull Plate - With bar-style handle. 3-1/2" x 15". Solid brass. Bright brass finish.



Product No.	Mfg. No.	Description	Order Mult.	Weight	Unit Cost
204656-C	C8311-5B3	3-1/2x15 Push Plate	1/0/2	1.700	34.49 CD

Tell Mfg. Inc.

Pull Plate - Visual packaged. 3-1/2" x 15" plate with 5-1/2" centers for pull. 5/8" diameter pull. Baked on clear lacquer finish. All necessary hardware is included. Satin stainless steel (US32D) finish. Pegable.



Product No.	Mfg. No.	Description	Order Mult.	Weight	Unit Cost
230685-D	PP351532/ 107X70B	3-1/2x15 Ss Pull Plate	1/0/5	1.000	22.99 EA

Tell Mfg. Inc.

Pull Plates - 18-gauge, 3-1/2" x 15" plate, 3/8" x 1-1/4" bar with 6" centers for pull. Countersunk holes. Baked on clear lacquer finish. 6 x 5/8" screws included. Available in aluminum (US28) finish.



Product No.	Mfg. No.	Description	Order Mult.	Weight	Unit Cost
204594-D	PFP351528	3-1/2x15 Alum Pull Plate	1/0/10	2.100	13.49 EA

Tell Mfg. Inc.

Pull Plates - 18-gauge, 3-1/2" x 15" plate, 3/8" x 1-1/4" bar with 6" centers for pull. Countersunk holes. Baked on clear lacquer finish. 6 x 5/8" screws included. Available in bright brass (US3) finish. Carded.



Product No.	Mfg. No.	Description	Order Mult.	Weight	Unit Cost
239290-C	PFP35153	3-1/2x15 Bb Pull Plate	1/0/10	2.100	23.49 EA

Tell Mfg. Inc.

Carded Pull Plate - Packaged for retail display. 3-1/2" x 15" with 5-1/2" centers for pull. Countersunk holes. Baked on clear lacquer finish. 6 x 5/8" screws included. Bright brass (US3) finish. Carded.



Product No.	Mfg. No.	Description	Order Mult.	Weight	Unit Cost
205060-D	PP35153	3-1/5x15 Bb Pull Plate	1/0/10	2.100	21.49 EA

H. B. Ives

Boxed Kick Plates - Kick plates are fabricated from the finest architectural aluminum, brass, and stainless steel. .037 gauge for protection at bottom of all doors. Screws included.



Product No.	Mfg. No.	Description	Order Mult.	Weight	Unit Cost
205125-C	C8400B3	Solid brass 6" x 34" visual pack	1/0/5	3.020	24.49 EA
205257-C	C8400B3	Solid brass 8" x 34" visual pack	1/0/5	3.960	32.49 EA
221953-C	C8400B3	Solid brass 6" x 30" visual pack	1/0/5	2.740	21.99 EA
221961-C	C8400B3	Solid brass 8" x 30" visual pack	1/0/5	3.540	28.49 EA
204898-C	8400PA28	Satin aluminum 8" x 28" bulk pack	1/0/5	2.400	12.49 EA
204914-C	8400PA28	Satin aluminum 8" x 34" bulk pack	1/0/5	3.060	14.99 EA
230693-D	8400S32D	Stainless steel 8" x 28" bulk pack	1/0/5	3.540	16.49 EA
205087-C	8400B3	Solid brass 6" x 28" bulk pack	1/0/5	2.800	19.49 EA
239263-C	8400B3	Solid brass 8" x 28" bulk pack	1/0/5	3.620	25.99 EA
239272-C	8400B3	Solid brass 8" x 34" bulk pack	1/0/5	4.180	31.49 EA
243647-C	C8400PA3	Gold anodized aluminum 8" x 30" visual pack	1/0/5	1.820	19.99 EA
204415-C	C8400PA3	Gold anodized aluminum 6" x 30" visual pack	1/0/5	3.340	19.79 EA
243655-C	C8400PA3	Gold anodized aluminum 6" x 34" visual pack	1/0/5	1.540	17.99 EA
243663-C	C8400PA3	Gold anodized aluminum 8" x 34" visual pack	1/0/5	1.960	21.99 EA

H. B. Ives

Kick Plate - Artisan Series. Fabricated from the finest Architectural brass. Lifetime warranty.

Product No.	Mfg. No.	Description	Order Mult.	Weight	Unit Cost
200785-C	C8400B-619	8 x 34, satin nickel (619) finish	1/0/5	4.320	69.99 EA
219873-C	C8400B-613	8 x 34, oil rubbed bronze (613) finish	1/0/5	4.320	72.99 EA
220031-C	C8400B-620	8 x 34, antique pewter (620) finish	1/0/5	4.320	74.99 EA

Tell Mfg. Inc.

Kick Plate - Kick plate, .050 gauge, 6" x 30" and 6" x 34", includes mounting screws. Carded.



Product No.	Mfg. No.	Description	Order Mult.	Weight	Unit Cost
201695-D	KP63032	Satin stainless steel (32D), 6" x 30"	1/0/5	3.800	12.49 EA
201702-D	KP63428	Brushed aluminum (28), 6" x 34"	1/0/5	3.800	8.99 EA

H. B. Ives

Magnetic Kick Plate - Solid brass magnetic kickplate. Easy-to-install. No tools required. Ideal for use on metal doors. Maintenance free. 8" x 34". Bright brass (US3) finish. Carded.



Product No.	Mfg. No.	Description	Order Mult.	Weight	Unit Cost
217565-C	C8400B3	8x34 Magnetic Kick Plate	1/0/5	6.000	35.49 EA

Tell Mfg. Inc.

Commercial Door Stop - Die-cast brass. Brushed chrome (26D). High rise profile. Poly bagged with wood screws and shield.



Product No.	Mfg. No.	Description	Order Mult.	Weight	Unit Cost
201711-D	FS3526	Chr High Rise Door Stop	1/0/10	.300	4.79 EA

Tell Mfg. Inc.

Commercial Wall Stop - Wrought stainless steel (26D). Polybagged with wood screws and plastic anchors. Convex.



Product No.	Mfg. No.	Description	Order Mult.	Weight	Unit Cost
201739-D	WS2026 26D	Ss Wall Stop	1/0/10	.300	2.79 EA

H. B. Ives

Door Guard - Aluminum construction. Bright brass finish. Bulk pack poly bag.



Product No.	Mfg. No.	Description	Order Mult.	Weight	Unit Cost
205511-C	SP482A3	Brass Door Guard	1/0/15	.700	5.79 EA

H. B. Ives

Floor Door Stop - Dome style floor door stop. Solid brass. 1" high. Bright brass finish.



Product No.	Mfg. No.	Description	Order Mult.	Weight	Unit Cost
205058-D	C436B3	Floor Door Stop	1/0/5	.240	5.79 CD

H. B. Ives

Wall Door Stop - Soft, high-grade nonmarring rubber. Great protection for walls and doors. Plastic drywall anchor for ease of installation. Concave rubber. Wrought brass. Bright brass finish.



Product No.	Mfg. No.	Description	Order Mult.	Weight	Unit Cost
205067-D	C407-1/2B3	Door Wall Stop	1/0/5	.300	4.99 CD

H. B. Ives

Door Stop - Flexible door stop with rubber tip bumper. 3" projection. Steel construction. Bright brass finish. Bulk pack poly bag.



Product No.	Mfg. No.	Description	Order Mult.	Weight	Unit Cost
205469-D	SP060F3	Door Stop	1/0/50	.058	.59 EA

H. B. Ives

Door Stop - Rigid door stop with rubber tip bumper. 3" projection. Aluminum construction. Bright brass finish. Bulk pack poly bag.



Product No.	Mfg. No.	Description	Order Mult.	Weight	Unit Cost
205487-D	SP61A3	Door Stop	1/0/25	.068	.99 EA

H. B. Ives

Door Stop - Epoxy-coated aluminum. Projection 3". 1 per card.



Product No.	Mfg. No.	Description	Order Mult.	Weight	Unit Cost
208434-C	C61AW	White	1/5/50	.014	3.79 EA

H. B. Ives

Wall Door Stop - Wall door stop with plastic drywall anchor. Concave rubber. Bulk pack poly bag.



Product No.	Mfg. No.	Description	Order Mult.	Weight	Unit Cost
205646-D	SP407-1/2B3	Wrought brass, bright brass finish	1/0/15	.173	3.79 EA
205673-C	SP407-1/2PA28	Anodized aluminum, satin aluminum finish	1/0/15	.173	3.29 EA

H. B. Ives

Door Holder - Kick-down style door holder. Aluminum material. 4" high.



Product No.	Mfg. No.	Description	Order Mult.	Weight	Unit Cost
205708-C	SP455A3	Bright brass finish	1/0/15	.207	4.79 EA
205691-D	SP455A92	Aluminum natural finish	1/0/15	.207	4.29 EA

BUMPERS

Tell Mfg. Inc.

Wall Mounted Knob-Type Door Stop And Bumper With Wood Screw - 1" projection, 2-3/8" base diameter. Concave rubber held with retaining ring. Backplate has prongs to prevent turning on wall after installation. Meets Federal Specification Type 1327. Bright brass (US3) finish.



Product No.	Mfg. No.	Description	Order Mult.	Weight	Unit Cost
212717-D	WS253/409-3	Bb Wall Stop	1/0/10	.300	2.79 EA

Tell Mfg. Inc.

Wall Mounted Knob-Type Door Stop And Bumper With Wood Screw - 1" projection, 2-3/8" base diameter. Concave rubber held with retaining ring. Backplate has prongs to prevent turning on wall after installation. Meets Federal Specification Type 1327. Aluminum (US32D) finish.



Product No.	Mfg. No.	Description	Order Mult.	Weight	Unit Cost
205389-D	WS2526/409-32D	Alum Wall Stop	1/0/10	.300	2.79 EA

Tell Mfg. Inc.

Wall Mounted Knob-Type Door Stop And Bumper With Wood Screw - 1" projection, 2-3/8" base diameter. Concave rubber held with retaining ring. Backplate has prongs to prevent turning on wall after installation. Meets Federal Specification Type 1327. Satin bronze (US10) finish.



Product No.	Mfg. No.	Description	Order Mult.	Weight	Unit Cost
205398-D	WS2510/409-10	Satin Brz Door Stop	1/0/10	.300	2.79 EA

Tell Mfg. Inc.

Floor Mounted Dome Type Door Stop And Bumper With Wood Screw And Fiber Plug - 1" H. Base: 2" x 1-7/8" x 5/32". Packed with fasteners for mounting in all types of floor construction including concrete. Meets Federal Specification Type 1330. Bright brass (US3) finish.

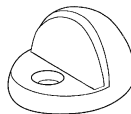

Product No.	Mfg. No.	Description	Order Mult.	Weight	Unit Cost
212725-D	FS303/440-US3	Bb Floor Stop	1/0/10	.300	4.49 EA

HARDWARE

Tell Mfg. Inc.

Floor Mounted Dome Type Door Stop And Bumper With Wood Screw And Fiber Plug - 1" high. Base: 2" x 1-7/8" x 5/32". Packed with fasteners for mounting in all types of floor construction including concrete. Meets Federal Specification Type 1330. Bronze (US10) finish.

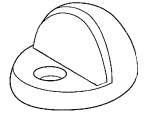

Product No.	Mfg. No.	Description	Order Mult.	Weight	Unit Cost
205094-D	FS3010/440-US10	Brz Floor Stop	1/0/10	.300	4.79 EA

Tell Mfg. Inc.

Floor Mounted Dome Type Door Stop And Bumper With Wood Screw And Fiber Plug - 1" high. Base: 2" x 1-7/8" x 5/32". Packed with fasteners for mounting in all types of floor construction including concrete. Meets Federal Specification Type 1330. Dull chromium-plated (US26D) finish.

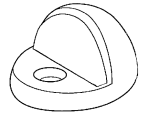

Product No.	Mfg. No.	Description	Order Mult.	Weight	Unit Cost
243469-D	FS3026/440-US26D	Chr Floor Stop	1/0/10	.153	4.79 EA

Tell Mfg. Inc.

Riser - 5/16" high. Use with FB13. FB13 x F14R: Federal Specification No. 1330A; BHMA No. L12161.



Product No.	Mfg. No.	Description	Order Mult.	Weight	Unit Cost
212644-D	FS373/444-3	Bright brass (US3) finish	1/0/10	.075	3.29 EA
243477-D	FS3726/444	Dull chromium-plated (US26D) finish	1/0/10	.075	3.29 EA

Tell Mfg. Inc.

Lever Type Door Holder With Wood Screw - Manufactured of cast iron. 4" kickdown. Operates by pushing arm down or raising it with toe.



Product No.	Mfg. No.	Description	Order Mult.	Weight	Unit Cost
205325-D	DH4026/458	Aluminum (AL)	1/0/10	.700	6.29 EA
207840-D	DH4010/458	Satin bronze (10)	1/0/10	.583	7.29 EA

HARDWARE

Tell Mfg. Inc.

Kick Down Holder - Constructed of heavy-duty cast metal construction. For doors with door to floor clearance of 2" or less. Provide hold and release, activated with a touch of the toe. Round nonmarring gray rubber shoes have corrugated bottoms to provide secure grip and a shank which forms own thread when screwed into threaded cavity of holder. Finish: Dull chromium-plated (US26D). Refer to model No. 1468 for replacement gray rubber shoe.

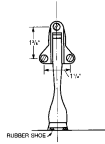

Product No.	Mfg. No.	Description	Order Mult.	Weight	Unit Cost
248398-D	DH00426/ 461-26D	Kickdown Holder	1/0/10	.700	14.79 EA

Tell Mfg. Inc.

Replacement Tip - For model No. DH00426. Threaded replaceable gray rubber shoe.

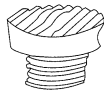

Product No.	Mfg. No.	Description	Order Mult.	Weight	Unit Cost
248509-D	1468/461B	Gray Replace Shoe Tip	1/0/10	.300	.99 EA

Hillman Fastner Corp

Picture Wire - Braided to prevent frayed ends. Tangleproof.

Product No.	Mfg. No.	Description	Order Mult.	Weight	Unit Cost
220558-D	121106	No. 2 wire, 25' coil	10/0/100	.110	1.29 CD
214736-E	121110	No. 3 wire, 25' coil	10/0/100	.150	1.79 CD
219096-D	121112	No. 4 wire, 25' coil	10/0/100	.170	1.99 CD

Hillman Fastner Corp

Picture Hanging Set - Braided to prevent frayed ends.



Product No.	Mfg. No.	Description	Order Mult.	Weight	Unit Cost
227098-D	121123	Hangs 5 light pictures, holds up to 5 lb., includes 5 hangers, 10 screw eyes, and 15' of No. 2 wire	10/0/100	.085	1.79 CD
227141-D	121127	Holds up to 20 lb, includes 5 hangers, 10 screw eyes, and 15' of No. 3 wire	10/0/100	.123	1.79 CD

Hillman Fastner Corp

Picture Mirror Cord Set - Heavy-duty. Holds up to 100 lb. Includes two 50 lb. hangers, 4 screw eyes and 10' of wire.



Product No.	Mfg. No.	Description	Order Mult.	Weight	Unit Cost
227123-D	121128	Picture/mirror Cord	10/0/100	.150	2.29 CD

MOUNTING TAPE

3M

Scotch™ Brand Mounting Tape - Self-sticking adhesive on both sides for fast, easy mounting jobs. High density foam which holds for extended periods of time. 4 sq. in. of tape supports 1 lb. of hanging weight.



Product No.	Mfg. No.	Description	Order Mult.	Weight	Unit Cost
224144-D	110P	1/2" x 75"	1/12/24	.064	3.79 CD
224180-D	114P	1" x 50"	1/12/24	.056	4.49 CD

3M

Scotch™ Brand Mounting Tape - Super strength self-sticking adhesives on both sides for fast, easy mounting jobs. Works in temperatures from 20° F. to 200° F. Resists weather, oil, gas, and detergents. Permanent use on glass, metals, and sealed wood. Most wall or floor surfaces, ceramic, and rigid plastics. Roll size: 1" x 50".



Product No.	Mfg. No.	Description	Order Mult.	Weight	Unit Cost
217484-D	316	1x50 H/d Mounting Tape	1/0/12	.292	5.29 EA

3M

Double-sided Foam Tape - Self-sticking on both sides for fast, easy mounting jobs. Double-sided foam tape is excellent for joining surfaces that are rough and/or irregular. Strong adhesion in high temperatures. Cushioning vibrations and dampening sound. Bond mirrors to walls. Bond acoustic panels to walls. 1/16" thick, 1" x 6 yd. Use 4" of tape for each pound of weight to be mounted.



Product No.	Mfg. No.	Description	Order Mult.	Weight	Unit Cost
250058-C	4026	1"x6yd Double-sided Tape	1/0/5	.420	17.79 CD

3M

Scotch™ Removable Mounting Squares - Clear removable double stick mounting squares. Holds securely, removes cleanly and easily from most objects, reposition and re-stick. Ideal for papers, photos and other lightweight items. Won't stain walls. For use on metal glass, wood, plastic, and almost all smooth surfaces. Holds up to 1 lb. 35 squares, .68" x .68".



Product No.	Mfg. No.	Description	Order Mult.	Weight	Unit Cost
251259-D	859	35pk Clr Mounting Square	1/0/24	.072	4.29 EA

HANGERS

Hillman Fastner Corp Picture Hanger -



Product No.	Mfg. No.	Description	Order Mult.	Weight	Unit Cost
220488-D	121010	10 lb. capacity; 8 per card	10/0/100	.050	.59 CD
220433-D	121030	30 lb. capacity; 6 per card	10/0/100	.055	.59 CD
220415-D	121100	100 lb. capacity; 2 per card	10/0/100	.070	.59 CD
226963-D	121020	20 lb. capacity; 8 per card	10/0/100	.020	.59 CD
226990-D	121050	50 lb. capacity; 3 per card	10/0/100	.059	.59 CD

Hillman Fastner Corp

E-Z Hanger - Hundreds of uses as utility or picture hangers. Hangs utensils, belts, brooms, pots and pans, wall plaques, picture frames, bulletin boards, raincoats, gadgets and many other uses in the home, office and shop. Decorative hammered brass finish.



Product No.	Mfg. No.	Description	Order Mult.	Weight	Unit Cost
214093-D	122180	10 lb. - 5 each	10/0/100	.038	.79 EA
214084-D	122182	20 lb. - 5 each	10/0/100	.038	.79 EA
214075-D	122184	40 lb. - 4 each	10/0/100	.047	.79 EA
214066-D	122186	60 lb. - 3 each	10/0/100	.056	.79 EA

Hillman Fastner Corp

Sawtooth Hangers - Sawtooth edge eliminates crooked pictures. Complete with nails.

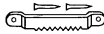

Product No.	Mfg. No.	Description	Order Mult.	Weight	Unit Cost
226151-D	121136	Self-leveling hanger, 5 per card	10/0/100	.058	.69 CD
215120-D	121140	Small self-leveling hangers, 6 per card	10/0/100	.050	.69 CD

Hillman Fastner Corp

Small Flat Ring Hangers - Lightweight flush mount hanger. For plaques, picture frames, and small shelves. Brass-plated. 4 per card.



Product No.	Mfg. No.	Description	Order Mult.	Weight	Unit Cost
240613-D	122225	Flat Ring Hange	10/0/100	.060	1.29 CD

Hillman Fastner Corp

D-Rings - For light to medium weight pictures, mirrors, and plaques. Zinc-plated. 4 per card.

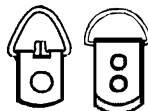

Product No.	Mfg. No.	Description	Order Mult.	Weight	Unit Cost
240621-D	122317	Small	10/0/100	.060	2.29 CD

HARDWARE

Hillman Fastner Corp

Mirror Holders - Transparent plastic clips prevent mirror from chipping. Includes 4 clips, 4 screws, and 4 anchors.

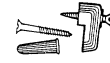

Product No.	Mfg. No.	Description	Order Mult.	Weight	Unit Cost
225544-D	121144	Mirror Holder	10/0/100	.050	.99 CD

National Mfg.

No-Rust Pulleys - Weather, scrapes, scratches or cuts will not make these pulleys rust. They stay smooth-operating and corrosion *Free*. Bodies are die-cast zinc, double-plated with copper and nickel. Sheaves are solid brass. Axles are rust-resistant steel. Quality throughout.



Product No.	Mfg. No.	Description	Order Mult.	Weight	Unit Cost
201169-C	N243568	Single sheave, swivel eye, size: 1/2", overall length: 1-7/16", maximum rope size: 3/16", eye size: 3/8"	1/10/50	.029	2.49 EA
237737-C	N243576	Single sheave, swivel eye, size: 3/4", overall length: 1-7/8", maximum rope size: 3/16", eye size: 7/16"	1/10/100	.150	2.49 EA
237611-D	N223370	Single sheave, swivel eye, size: 1", overall length: 2-3/4", maximum rope size: 1/4", eye size: 11/16"	1/10/100	.200	2.79 EA
201294-D	N243584	Single sheave, fixed eye, size: 1/2", overall length: 1-1/8", maximum rope size: 3/16", eye size: 3/16"	1/10/50	.024	1.79 EA
237648-D	N243592	Single sheave, fixed eye, size: 3/4", overall length: 1-9/16", maximum rope size: 3/16", eye size: 3/16"	1/10/50	.150	1.79 EA
237657-C	N223404	Single sheave, fixed eye, size: 1", overall length: 2-1/8", maximum rope size: 1/4", eye size: 1/4"	1/10/100	.200	1.99 EA
237684-C	N243600	Double sheave, fixed eye, size: 3/4", overall length: 1-5/8", maximum rope size: 3/16", eye size: 3/16"	1/5/25	.220	2.99 EA
237693-C	N223420	Double sheave, fixed eye, size: 1", overall length: 2-1/8", maximum rope size: 1/4", eye size: 1/4"	1/5/25	.500	3.49 EA

National Mfg.

Fixed Eye Double Steel Pulley - Extra weight capacity for high working loads. Dual wheel pulley has 1-1/2" sheave. Removable axle for easy rigging. Fixed eye dual steel pulley has 3/8" rope capacity.



Product No.	Mfg. No.	Description	Order Mult.	Weight	Unit Cost
237700-C	N199810	1-1/2" Double Pulley	1/5/25	1.600	7.29 EA

HARDWARE

PULLEYS

National Mfg.

Swivel Eye Steel Pulley - Extra weight capacity for high working loads. Select 1-1/2" or 2" for capacities of 420 lb. or 480 lb. respectively. Removable axle for easy rigging. Swivel eye steel pulley has 3/8" rope capacity.



Product No.	Mfg. No.	Description	Order Mult.	Weight	Unit Cost
237620-D	N195784	1-1/2" Swivel Eye Pulley	1/0/5	.500	6.29 EA
237639-D	N195792	2" Swivel Eye Pulley	1/0/5	1.000	7.99 EA

National Mfg.

Fixed Eye Steel Pulley - Extra weight capacity for high working loads. Select 1-1/2" or 2" for capacities of 420 lb. or 480 lb. respectively. Removable axle for easy rigging. Fixed eye steel pulley has 3/8" rope capacity.



Product No.	Mfg. No.	Description	Order Mult.	Weight	Unit Cost
237666-D	N195800	1-1/2" Fixed Eye Pulley	1/0/5	.500	5.49 EA
237675-D	N195818	2" Fixed Eye Pulley	1/0/5	1.000	6.99 EA

National Mfg.

Rope Cleat - Weather, scrapes, scratches, or cuts will not make these cleats rust. Bodies are die-cast zinc, double-plated with copper and nickel. Nickel finish.



Product No.	Mfg. No.	Description	Order Mult.	Weight	Unit Cost
201374-C	N223321	2-1/2", boxed	1/10/100	.027	.79 EA
237719-D	N223339	4-1/2", boxed	1/10/50	.100	1.29 EA
237728-C	N223347	6", boxed	1/10/50	.150	1.79 EA

National Mfg.

Rope Cleat - Manufactured of die-cast zinc. Bright brass finish. Size: 2-1/2".



Product No.	Mfg. No.	Description	Order Mult.	Weight	Unit Cost
242039-C	N223313	2-1/2" Bb Rope Cleat	1/10/50	.025	.79 EA

Lehigh Group/Crawford

Heavy-Duty Straight Peg Hooks - For 1/4" perforated board. Heavy-duty, zinc-plated. American made. Shelf-pack (open stock).



Product No.	Mfg. No.	Description	Order Mult.	Weight	Unit Cost
225320-D	14460-125	6"; 125-pieces per carton	0/0/1	16.000	42.99 CTN
225339-D	14480-100	8"; 100-pieces per carton	0/0/1	14.900	49.99 CTN

Lehigh Group/Crawford

Heavy-Duty Peg Hooks - For 1/4" pegboard. Heavy-duty zinc-plated 10" straight hook with steel ball ends. Bulk pack.



Product No.	Mfg. No.	Description	Order Mult.	Weight	Unit Cost
253367-D	14510-75	10" Straight Hook	0/0/75	.149	.69 EA

Lehigh Group/Crawford

Curved Peg Hook - 1/4" with peg locks. For 1/8" or 1/4" perforated board. Zinc-plated. American made. Display carded. 8 hooks per card.

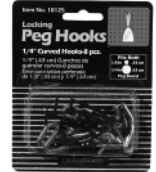

Product No.	Mfg. No.	Description	Order Mult.	Weight	Unit Cost
215910-D	18125	1/4" Curved Hooks	1/0/12	.187	1.29 CD

Lehigh Group/Crawford

Curved Peg Hooks - For 1/8" or 1/4" perforated board. Zinc-plated. American made. Display carded.



Product No.	Mfg. No.	Description	Order Mult.	Weight	Unit Cost
215929-D	18150	1/2" with peg locks; 8 per card	1/0/12	.194	1.29 CD
215937-D	18110	1" with peg locks; 6 per card	1/0/12	.174	1.29 CD

Lehigh Group/Crawford

Straight Double Peg Hooks - 2". For 1/8" or 1/4" perforated board. Zinc-plated with yellow safety tips to protect sharp ends. American made. Display carded. 2 hooks per card.



Product No.	Mfg. No.	Description	Order Mult.	Weight	Unit Cost
216062-D	18422	2" Double Arm Hooks	1/0/12	.174	1.29 CD

Lehigh Group/Crawford

Heavy-Duty Straight Peg Hooks - For 1/4" perforated board. Heavy-duty, zinc-plated with yellow safety tips to protect sharp ends. American made. Display carded. 2 hooks per card.



Product No.	Mfg. No.	Description	Order Mult.	Weight	Unit Cost
216119-E	14340	4"	1/0/12	.268	1.79 CD
216127-D	14360	6"	1/0/12	.226	1.79 CD
216135-D	14380	8"	1/0/12	.356	1.79 CD

PEG HOOKS

GeoMatrix

Vinyl Pegboard Hooks - Pegmaster vinyl pegboard hooks. 12 each, white.

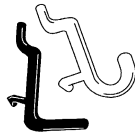

Product No.	Mfg. No.	Description	Order Mult.	Weight	Unit Cost
112984-C	HOOKS	12pk Wht Vinyl Hooks	1/0/24	.083	4.99 BG

Lehigh Group/Crawford

Heavy-Duty Double Peg Hooks - 4". For 1/4" perforated board. Heavy-duty, zinc-plated with yellow safety tips to protect sharp ends. American made. Display carded. 2 hooks per card.



Product No.	Mfg. No.	Description	Order Mult.	Weight	Unit Cost
216143-D	14444	4" Double Arm Hooks	1/0/12	.334	1.99 CD

National Mfg.

Mar-Proof Storage Hooks - Heavy-duty steel construction. Vinyl coated to prevent marring. Suitable to hang just about everything.



Product No.	Mfg. No.	Description	Order Mult.	Weight	Unit Cost
235695-D	N221044	2-3/4" Storage Hook	40/0/200	.136	1.29 EA

National Mfg.

Mar-Proof Storage Hook - Suitable for hanging just about everything. Vinyl coated to prevent marring. Heavy-duty steel construction. Size: 4" and 6".



Product No.	Mfg. No.	Description	Order Mult.	Weight	Unit Cost
235702-D	N221010	4"	40/0/160	.173	.99 EA
235711-C	N221028	6"	40/0/160	.215	.99 EA

National Mfg.

Storage Hook - Suitable for hanging bicycles, ladders, lawn and garden equipment. Vinyl coated to prevent marring. Steel construction.



Product No.	Mfg. No.	Description	Order Mult.	Weight	Unit Cost
233820-D	N221036	6-1/2" Storage Hook	40/0/160	.176	.79 EA

HARDWARE

Lehigh Group/Crawford

Screw-In Bicycle Hooks - Gray vinyl-coating. 2 per card.



Product No.	Mfg. No.	Description	Order Mult.	Weight	Unit Cost
215171-D	SS18	Screw-in Bicycle Hook	1/12/72	.417	1.49 SET

Lehigh Group/Crawford

Hammer-In All-Purpose Hook - Gray vinyl-coating. 2 per card.



Product No.	Mfg. No.	Description	Order Mult.	Weight	Unit Cost
215198-D	HS15	Hammer-in Hooks	1/0/12	.250	1.49 SET

Lehigh Group/Crawford

Hammer-In All-Purpose Hook - Gray vinyl-coating. 3 per card.



Product No.	Mfg. No.	Description	Order Mult.	Weight	Unit Cost
215201-D	HS16	Hammer-in Hooks	1/0/12	.250	1.49 SET

National Mfg.

Storage Hook - Red vinyl-coating to prevent marring for hanging items either overhead or from sidewalls. Perfect for storing skis, lumber, ladders, patio furniture, etc.



Product No.	Mfg. No.	Description	Order Mult.	Weight	Unit Cost
205566-D	N220848	Red Storage Hook	40/0/160	.273	1.49 EA

Lehigh Group/Crawford

Rafter Hanger - Heavy-duty storage hanger holds up to 50 lb. Hanger has a tough supergrip, no-mar vinyl-coating. Hang fiberglass ladders, sports gear etc.



Product No.	Mfg. No.	Description	Order Mult.	Weight	Unit Cost
251364-D	SH26-25	Rafter Hanger	1/0/25	.568	1.99 EA

HARDWARE

STORAGE HOOKS

Lehigh Group/Crawford

Swivel Hanger - Heavy-duty 10" swivel hanger holds up to 50 lb. No-mar foam sleeve. Mounting hardware is included. Saves space, swings flat against wall when not in use. Swivels 180°.



Product No.	Mfg. No.	Description	Order Mult.	Weight	Unit Cost
251372-D	HSWH	Swivel Hanger	1/0/12	1.192	3.99 EA

Lehigh Group/Crawford

Double Arm Hook - Double strong, 6" arms with 4" high ends holds up to 100 lb. Has a no-mar foam sleeve to protect valuable items. Mounting hardware is included.



Product No.	Mfg. No.	Description	Order Mult.	Weight	Unit Cost
251380-D	HHA2	Double Arm Hook	1/0/12	1.467	5.99 EA

Lehigh Group/Crawford

Jumbo Arm Hanger - Heavy-duty jumbo 12" arm is designed to hold 50 lb. No-mar foam sleeves to protect valuable items. Mounting hardware is included.



Product No.	Mfg. No.	Description	Order Mult.	Weight	Unit Cost
251399-D	HGSH	Jumbo Arm Storage Hook	1/0/24	1.375	5.99 EA

Lehigh Group/Crawford

Giant Storage Hangers - Heavy-gauge plated steel tubing. Rust-resistant finish. Includes no-mar plastic caps and mounting hardware. For use in garages or basements, for hanging lawn furniture, sporting equipment, ladders, lumber, pipe, etc. 2 per card.



Product No.	Mfg. No.	Description	Order Mult.	Weight	Unit Cost
201855-D	GSH	2pk Storage Hanger	1/0/12	1.833	8.79 CD

Lehigh Group/Crawford

Hang-Up Brackets - Rust-resistant finish. Great for hanging up shelves, tires, or ladders. 2 per card.



Product No.	Mfg. No.	Description	Order Mult.	Weight	Unit Cost
215856-D	UHS3	Hang-up Utility Bracket	1/0/12	.667	2.49 CD

Lehigh Group/Crawford

Deluxe Overhead Hook - Create more storage space. Mounts to ceiling beams and rafters.



Product No.	Mfg. No.	Description	Order Mult.	Weight	Unit Cost
210889-D	13010	Deluxe Overhead Hook	1/0/12	1.968	8.99 EA

Prime Line Prod.

Flat Shower Door Roller - Flat nylon roller with steel center gliding on ball bearings. 3/4" diameter x 3/8" wide. 1 pair per card.

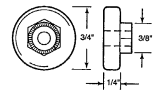

Product No.	Mfg. No.	Description	Order Mult.	Weight	Unit Cost
235725-D	1901-B	Flat Shower Door Roller	1/0/6	.068	1.79 PR

Prime Line Prod.

Oval Shower Door Roller - Oval nylon roller with steel center gliding on ball bearings. 3/4" diameter x 3/8" wide. Hardware is included. 1 pair per card.

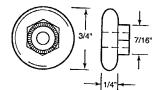

Product No.	Mfg. No.	Description	Order Mult.	Weight	Unit Cost
235733-D	1901-A	3/4" Shower Door Roller	1/0/6	.065	1.79 PR

Prime Line Prod.

Flat Shower Door Roller - Flat nylon roller with steel center gliding on ball bearings. 7/8" diameter x 3/8" wide. Hardware included. 1 pair per card.

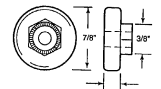

Product No.	Mfg. No.	Description	Order Mult.	Weight	Unit Cost
235741-D	19507	7/8" Shower Door Roller	1/0/6	.072	1.79 PR

SHOWER DOOR PARTS

HARDWARE

Prime Line Prod.

Oval Shower Door Roller - Oval nylon roller with steel center. Gliding on ball bearings. 7/8" diameter x 3/8" wide. 1 pair per card.

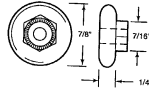

Product No.	Mfg. No.	Description	Order Mult.	Weight	Unit Cost
235768-D	1901	7/8" Shower Door Roller	1/0/6	.072	1.79 PR

Prime Line Prod.

Shower Door Guide - Nylon shower door guide. 1 pair per card.

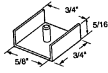

Product No.	Mfg. No.	Description	Order Mult.	Weight	Unit Cost
235822-D	19638	Nylon Shower Door Guide	1/0/6	.033	1.79 PR

Prime Line Prod.

Shower Door Bottom Guide - Nylon bottom guide for sliding tub enclosure doors, fits 7/16" thick door rails, used by several shower door manufacturers.

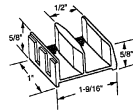

Product No.	Mfg. No.	Description	Order Mult.	Weight	Unit Cost
235830-D	192971	2 per card	1/0/6	.061	1.49 PR
258970-E	191680	1 per card	1/0/6	.038	1.49 CD

Prime Line Prod.

Shower Door Seal - Gray vinyl shower door seal. 37" L. x 1-9/16" W. Contents: 1 seal.



Product No.	Mfg. No.	Description	Order Mult.	Weight	Unit Cost
236322-D	19200	Shower Door Seal	1/0/6	.089	1.99 EA

Prime Line Prod.

Shower Door Snap - Manufactured of nylon and steel. Stainless steel housing with a nylon snap. 1 per card.

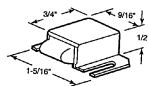

Product No.	Mfg. No.	Description	Order Mult.	Weight	Unit Cost
235709-D	1932	Shower Door Snap	1/0/6	.049	1.79 EA

Prime Line Prod.

Shower Door Bumper - Anti-slam protective bumper for sliding shower doors. 3/4" diameter. 1 per card.

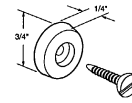

Product No.	Mfg. No.	Description	Order Mult.	Weight	Unit Cost
240389-D	19551	Shower Door Bumper	1/0/6	.002	1.49 PK

Prime Line Prod.

Shower Door Seal - Heavy-duty shower door seal. 33" L. x 1-7/16" W. Manufactured of gray vinyl material. 1 per card.



Product No.	Mfg. No.	Description	Order Mult.	Weight	Unit Cost
206490-D	19685	Shower Door Seal	1/0/6	.126	2.79 EA

Prime Line Prod.

Rear Drawer Roller Bracket - 3-21/64". Manufactured from steel with white nylon roller. 1 each per visual pack. Left hand.

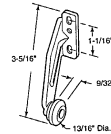

Product No.	Mfg. No.	Description	Order Mult.	Weight	Unit Cost
236330-D	22797	Rear Roller Bracket	1/0/6	.110	1.79 EA

Prime Line Prod.

Rear Roller Bracket - 3-3/8" overall length. Manufactured from steel with white nylon roller. 2 per visual pack. Right hand.

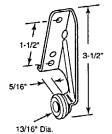

Product No.	Mfg. No.	Description	Order Mult.	Weight	Unit Cost
216747-D	223003	Rear Roller Bracket	1/0/6	.096	3.29 EA

Prime Line Prod.

Front Drawer Roller Bracket - Left and right. Manufactured of white nylon and steel.

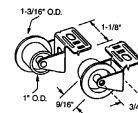

Product No.	Mfg. No.	Description	Order Mult.	Weight	Unit Cost
235717-D	22798	Roller Bracket	1/0/6	.077	2.49 PR

HARDWARE

DRAWER PARTS

Prime Line Prod.

Track Guide - 1-1/4". For guiding drawer along track. Manufactured from nylon. White. 1 per visual pack.

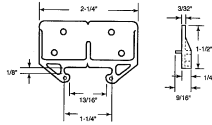

Product No.	Mfg. No.	Description	Order Mult.	Weight	Unit Cost
216801-E	22793	1-1/4" Nylon Track Guide	1/0/6	.072	1.29 EA

Prime Line Prod.

Track Guide - 7/8". For guiding drawer along track. Manufactured from nylon. White. 1 per visual pack.

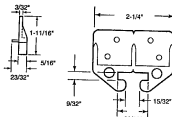

Product No.	Mfg. No.	Description	Order Mult.	Weight	Unit Cost
216836-E	22315	7/8" Nylon Track Guide	1/0/6	.072	1.29 EA

Prime Line Prod.

Track Guide - 1-3/16". For guiding drawer along track. Manufactured from nylon. White. 1 per visual pack.

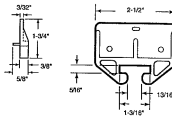

Product No.	Mfg. No.	Description	Order Mult.	Weight	Unit Cost
216879-E	22495	1-3/16" nylon Track Guide	1/0/6	.072	1.29 EA

Prime Line Prod.

Drawer Track Guide Kit - White polyethylene guide and white polyethylene side saddles; restores smooth operation of track mounted drawers. Fits a 1/4" x 1-1/16" track. Contents: 1 guide, 2 side saddles, and 1 set of installation fasteners.

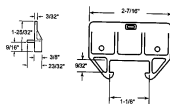

Product No.	Mfg. No.	Description	Order Mult.	Weight	Unit Cost
216887-D	222186	White Nylon Track Guide	1/0/6	.072	1.29 EA

Prime Line Prod.

Track Guide - 13/16". For guiding drawer along track. Manufactured from nylon. White. 1 per visual pack.

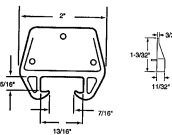

Product No.	Mfg. No.	Description	Order Mult.	Weight	Unit Cost
218588-E	22486	13/16" Nylon Track Guide	1/0/6	.072	1.29 PR

Prime Line Prod.

Track Guide - 1-1/8". For guiding drawer along track. Manufactured from nylon. White. 1 per visual pack.

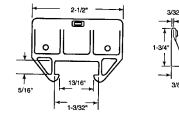

Product No.	Mfg. No.	Description	Order Mult.	Weight	Unit Cost
218677-E	221904	1-1/8" Nylon Track Guide	1/0/6	.072	1.29 EA

Prime Line Prod.

Track Guide - 13/16". For guiding drawer along track. Manufactured from nylon. White. 1 per visual pack.

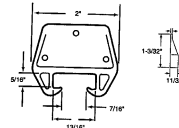

Product No.	Mfg. No.	Description	Order Mult.	Weight	Unit Cost
218685-D	222019	13/16" Nylon Track Guide	1/0/6	.072	1.29 EA

Prime Line Prod.

Track Guide - 11/16". For guiding drawer along track. Manufactured from nylon. White. 1 per visual pack.

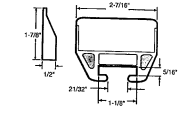

Product No.	Mfg. No.	Description	Order Mult.	Weight	Unit Cost
218731-D	221376	11/16" Nylon Track Guide	1/0/6	.072	1.49 EA

Prime Line Prod.

Track Guide Kit - For guiding drawer along track. Manufactured from white nylon. Kit includes 2 plastic guides, 4 plastic wear strips model No. 22843 and mounting hardware.

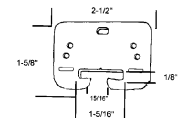

Product No.	Mfg. No.	Description	Order Mult.	Weight	Unit Cost
205788-E	22794	White Nylon Track Guide	1/0/6	.063	1.29 EA

Prime Line Prod.

Track Guide Kit - For guiding drawer along track. Manufactured from nylon. White. Kit includes 1 plastic guides, 2 plastic wear strips.

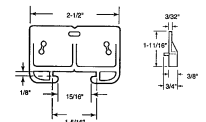

Product No.	Mfg. No.	Description	Order Mult.	Weight	Unit Cost
206350-E	22625	White Nylon Track Guide	1/0/6	.032	1.29 EA

DRAWER PARTS

Prime Line Prod.

Track Bracket - Horizontal and vertical. For drawer track. Manufactured from nylon. White. 1 per visual pack.

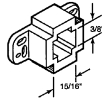

Product No.	Mfg. No.	Description	Order Mult.	Weight	Unit Cost
216798-D	221392	Wht Nylon Track Bracket	1/0/6	.072	1.49 EA

Prime Line Prod.

Track Socket - 1/2" x 7/8" nylon track socket for drawers. 1 per card.

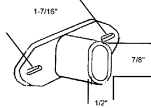

Product No.	Mfg. No.	Description	Order Mult.	Weight	Unit Cost
206458-E	221379	Nylon Track Socket	1/0/6	.025	1.29 EA

Prime Line Prod.

Track Socket - 1-1/4" x 5/8" nylon track sockets for drawers. 2 per card.

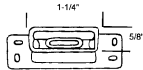

Product No.	Mfg. No.	Description	Order Mult.	Weight	Unit Cost
205583-E	22842	Nylon Track Socket	1/0/6	.047	1.29 PK

Prime Line Prod.

Track Socket - 1-1/4" x 1-1/2" nylon track sockets for drawers. 1 per card.

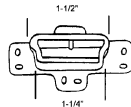

Product No.	Mfg. No.	Description	Order Mult.	Weight	Unit Cost
205699-E	22844	Nylon Track Socket	1/0/6	.047	1.29 EA

Prime Line Prod.

Track Hanger - Nylon track hangers for drawers. Fits 13/16" wide track. 1 per card.

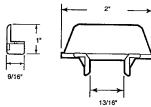

Product No.	Mfg. No.	Description	Order Mult.	Weight	Unit Cost
205710-E	22485	Nylon Track Hanger	1/0/6	.032	1.29 EA

HARDWARE

Prime Line Prod.

Plastic Wear Strip - 1/2" x 1-1/16" plastic wear strips for drawers. 10 per card and 20 fasteners.

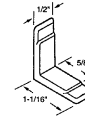

Product No.	Mfg. No.	Description	Order Mult.	Weight	Unit Cost
205567-E	22843	Plastic Wear Strips	1/0/6	.027	1.29 PK

Prime Line Prod.

Track Socket - 5/16" x 15/16" square nylon track socket for drawers. 1 per card.

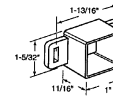

Product No.	Mfg. No.	Description	Order Mult.	Weight	Unit Cost
206369-E	221374	Rear Roller Bracket	1/0/6	.025	1.29 EA

Prime Line Prod.

Rear Roller Bracket - Steel bracket with nylon roller for drawers. 1 per card.

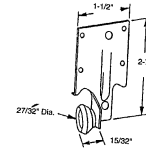

Product No.	Mfg. No.	Description	Order Mult.	Weight	Unit Cost
206407-D	221240	Rear Roller Bracket	1/0/6	.024	1.79 EA

Prime Line Prod.

Front By-Pass Hanger - Front by-pass hanger for by-pass doors. Manufactured of nylon and steel. 1/4" offset, 7/8" wheel. Hardware is included. 1 pair per card.

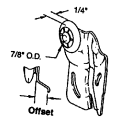

Product No.	Mfg. No.	Description	Order Mult.	Weight	Unit Cost
236411-D	16257-F	Front Bi-pass Hanger	1/0/6	.195	2.99 PR

Prime Line Prod.

Back By-Pass Hanger - Manufactured of white nylon and steel. Back by-pass hanger with 7/16" offset, 1/2" wheel. Hardware is included. 1 pair per card.

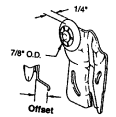

Product No.	Mfg. No.	Description	Order Mult.	Weight	Unit Cost
236438-D	16257-B	Back Bi-pass Hanger	1/0/6	.192	2.99 PR

HARDWARE

DOOR PARTS

Prime Line Prod.

By-Pass Hanger - Single wheel hanger for by-pass doors. 1/16" offset, 7/8" flat nylon roller with steel body. Primarily used on L.E. Johnson style doors. Hardware is included. 1 set per card.

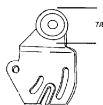

Product No.	Mfg. No.	Description	Order Mult.	Weight	Unit Cost
204323-D	161150	Sgl Wheel By-pass Hanger	1/0/6	.188	2.99 PR

Prime Line Prod.

By-Pass Hanger - Single wheel hanger for by-pass doors. 3/8" offset, 7/8" flat nylon roller with steel body. Primarily used on L.E. Johnson style doors. Hardware included. 1 set per card.

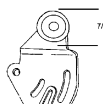

Product No.	Mfg. No.	Description	Order Mult.	Weight	Unit Cost
204331-D	161151	Sgl Wheel By-pass Hanger	1/0/6	.188	2.99 PR

Prime Line Prod.

Single Wheel Hanger - Single wheel hanger for by-pass doors. 1/4" offset, 7/8" oval nylon roller. Hardware is included. 1 pair per card.

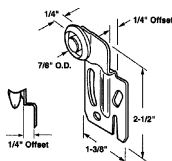

Product No.	Mfg. No.	Description	Order Mult.	Weight	Unit Cost
236594-D	16216-F	Single Wheel Hanger	1/0/6	.189	3.29 PR

Prime Line Prod.

Single Wheel Hanger - Single wheel hanger for by-pass doors. 1/2" offset, 7/8" oval nylon roller. Hardware is included. 1 pair per card.

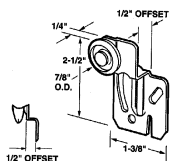

Product No.	Mfg. No.	Description	Order Mult.	Weight	Unit Cost
236608-D	16216-B	Single Wheel Hanger	1/0/6	.189	3.29 PR

Prime Line Prod.

Single Wheel Hanger - Single wheel hanger for by-pass doors. 1/4" offset, 3/4" flat nylon roller. Hardware is included. 1 pair per card.

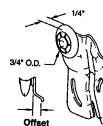

Product No.	Mfg. No.	Description	Order Mult.	Weight	Unit Cost
236616-D	16224-F	Single Wheel Hanger	1/0/6	.195	2.99 PR

Prime Line Prod.

Single Wheel Hanger - Single wheel hanger for by-pass doors. 1/2" offset, 3/4" flat nylon roller. Hardware is included. 1 pair per card.

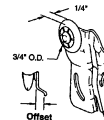

Product No.	Mfg. No.	Description	Order Mult.	Weight	Unit Cost
236624-D	16224-B	Single Wheel Hanger	1/0/6	.191	2.99 PR

Prime Line Prod.

Adjustable Floor Guide - 3/4" white nylon adjustable floor guide for by-pass doors. Hardware is included. 1 per card.



Product No.	Mfg. No.	Description	Order Mult.	Weight	Unit Cost
204315-E	16136	Adjustable Floor Guide	1/0/6	.067	1.29 EA

Prime Line Prod.

Adjustable Floor Guide - 1" nylon adjustable floor guide for by-pass doors. Hardware is included. 2 per card.

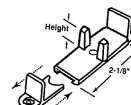

Product No.	Mfg. No.	Description	Order Mult.	Weight	Unit Cost
236748-D	163498	Adjustable Floor Guide	1/0/6	.088	1.79 PR

Prime Line Prod.

Adjustable Floor Guide - 1-1/4" adjustable floor guide for by-pass doors. Hardware is included. 2 per card.

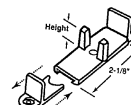

Product No.	Mfg. No.	Description	Order Mult.	Weight	Unit Cost
236683-D	163236	Adjustable Floor Guide	1/0/6	.103	3.29 CD

Prime Line Prod.

Adjustable Floor Guide - Manufactured of white nylon and metal. 1 1/16" adjustable floor guide for by-pass doors. Hardware included. 1 per card.

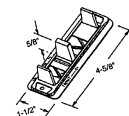

Product No.	Mfg. No.	Description	Order Mult.	Weight	Unit Cost
236543-D	16217	Adjustable Floor Guide	1/0/6	.128	2.49 EA

DOOR PARTS

HARDWARE

Prime Line Prod.

Closest Door Floor Guide - For use on by-pass wardrobe door. Nylon construction for 1-3/8" thick doors. Universal design. 1 per card.

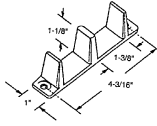

Product No.	Mfg. No.	Description	Order Mult.	Weight	Unit Cost
204358-D	16451	Closest Door Floor Guide	1/6/72	.068	1.29 EA

Prime Line Prod.

Bottom Pivot - Bottom pivot for bi-fold doors. Manufactured of nylon and steel. 7/16" O.D. hole. Contents: 1 per card.

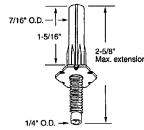

Product No.	Mfg. No.	Description	Order Mult.	Weight	Unit Cost
236365-D	161145	Bi-fold Dr Bottom Pivot	1/0/6	.076	1.99 EA

Prime Line Prod.

Bottom Pivot Bracket - Steel bottom bracket for bi-fold doors. Nylon base on pin. 1 set per card.

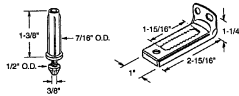

Product No.	Mfg. No.	Description	Order Mult.	Weight	Unit Cost
236632-D	162107	Bottom Pivot Bracket	1/0/6	.231	3.49 EA

Prime Line Prod.

Top Pivot Guide - Top pivot guide for bi-fold doors. 2-9/16" length. Springloaded with nylon cap. 1 per card.

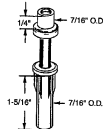

Product No.	Mfg. No.	Description	Order Mult.	Weight	Unit Cost
236349-D	161144	Top Pivot Guide	1/0/6	.105	1.79 EA

Prime Line Prod.

Top Pivot Guide - Top pivot guide for bi-fold doors. Manufactured of nylon. 3/8" hole. Contents: 1 pair per card.

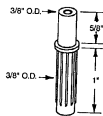

Product No.	Mfg. No.	Description	Order Mult.	Weight	Unit Cost
236381-E	161678	Top Pivot Guide	1/0/6	.043	1.79 PR

Prime Line Prod.

Top Pivot Guide - 1-3/4" top pivot guide for bi-fold doors. Steel body and steel stem. Hardware is included. 1 per card.

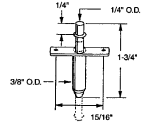

Product No.	Mfg. No.	Description	Order Mult.	Weight	Unit Cost
236403-D	16471	Top Pivot Guide	1/0/6	.060	2.29 EA

Prime Line Prod.

Top Pivot Guide - Top pivot guide for bi-fold doors. Nylon body with steel stem 3/4" nylon cap spring mounted self adjusting. Fits 1" to 1-3/8" thick doors. 1 per card.

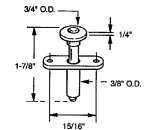

Product No.	Mfg. No.	Description	Order Mult.	Weight	Unit Cost
204412-E	16467	Top Pivot Guide	1/0/6	.054	2.29 EA

Prime Line Prod.

Top Pivot Guide - For use on bi-fold doors. Nylon body with steel stem 7/8" nylon cap spring mounted/self adjusting. Fits 1" to 1-3/8" thick bi-fold doors. 1 per card.

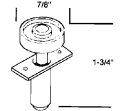

Product No.	Mfg. No.	Description	Order Mult.	Weight	Unit Cost
204420-E	16596	Top Pivot Guide	1/0/6	.054	2.29 EA

Prime Line Prod.

Top Pivot Guide - Top pivot guide for bi-fold doors. Nylon body. Steel stem. 1 per card. Used by many wardrobe door manufacturers.

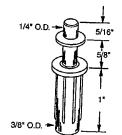

Product No.	Mfg. No.	Description	Order Mult.	Weight	Unit Cost
236470-E	161111	Top Pivot Door Guide	1/0/6	.085	1.79 EA

Prime Line Prod.

Top Pivot Guide - 2" top pivot guide for bi-fold doors. Manufactured of nylon and steel. Spring loaded. 7/8" nylon cap riveted on. 1 per card.

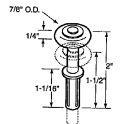

Product No.	Mfg. No.	Description	Order Mult.	Weight	Unit Cost
236489-D	161109	Top Pivot Door Guide	1/0/6	.091	1.79 EA

Prime Line Prod.

Top Pivot Guide - Top pivot guide for bi-fold doors. Manufactured of nylon. Spring loaded. 19/32" nylon cap. 1 pair per card.

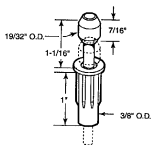

Product No.	Mfg. No.	Description	Order Mult.	Weight	Unit Cost
236497-D	162014	Top Pivot Guide	1/0/6	.092	2.29 PR

Prime Line Prod.

Top Pivot Guide - Top pivot guide for bi-fold doors. Manufactured of nylon. Spring loaded. 3/4" nylon cap. 1 pair per card.

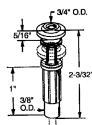

Product No.	Mfg. No.	Description	Order Mult.	Weight	Unit Cost
236500-D	162015	Top Pivot Guide	1/0/6	.090	2.29 PR

Prime Line Prod.

Top Pivot Guide - Top pivot guide for bi-fold doors. Manufactured of nylon and steel. Spring loaded. 3/8" nylon cap. 1 pair per card.

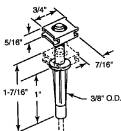

Product No.	Mfg. No.	Description	Order Mult.	Weight	Unit Cost
236519-D	161978	Top Pivot Guide	1/0/6	.092	3.49 PR

Prime Line Prod.

Top Pivot Guide - All steel body and stem with nylon guide cap. 2-5/8" top pivot guide for bi-fold doors. 1 per card.

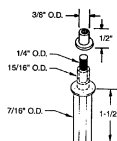

Product No.	Mfg. No.	Description	Order Mult.	Weight	Unit Cost
236551-E	16260	Top Pivot Guide	1/0/6	.151	1.79 EA

Prime Line Prod.

Top Pivot Roller - Top pivot guide for bi-fold doors. Manufactured of nylon and steel. 7/8" nylon cap. 1 pair per card.

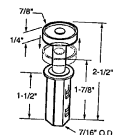

Product No.	Mfg. No.	Description	Order Mult.	Weight	Unit Cost
236578-D	16215	Top Pivot Roller	1/0/6	.157	3.29 PR

Prime Line Prod.

Top Pivot Guide - Top pivot guide for bi-fold doors. Manufactured of nylon and steel. 4" nylon with 2 springs. 1 per card.

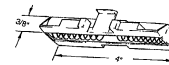

Product No.	Mfg. No.	Description	Order Mult.	Weight	Unit Cost
236535-D	16472	Top Pivot Guide	1/0/6	.080	1.79 EA

Prime Line Prod.

Snugger - 4-door snugger for use on bi-fold doors. Plastic construction with steel spring. snaps into top track, self adjusting, fits holes in doors in closed position. 3/4" body with 2" spring. For use on Cox and other styles of doors. 1 per card.

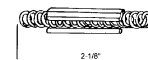

Product No.	Mfg. No.	Description	Order Mult.	Weight	Unit Cost
204390-D	161101	Bi-fold Door Snugger	1/0/6	.062	1.79 EA

Prime Line Prod.

Bottom Pivot Bolt - Bottom pivot guide for bi-fold doors. Manufactured of nylon and steel. Fits 1" to 1-3/8" bifold doors to 30 lb. each. 2 per card.

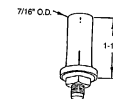

Product No.	Mfg. No.	Description	Order Mult.	Weight	Unit Cost
236527-D	161902	Bottom Pivot Bolt	1/0/6	.121	4.29 PR

Prime Line Prod.

Bottom Pivot Guide - All steel bottom pivot bolt for bi-fold doors. 1/4" steel bolt. 1 per card.

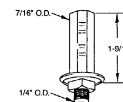

Product No.	Mfg. No.	Description	Order Mult.	Weight	Unit Cost
236586-D	16261	Bottom Pivot Guide	1/0/6	.144	1.99 EA

Prime Line Prod.

Bottom Pivot Guide - 2-1/16" minimum height x 15/16" maximum height x 9/16" nylon body with starred head. 1 pair per card.



Product No.	Mfg. No.	Description	Order Mult.	Weight	Unit Cost
204986-E	161934	Bottom Pivot Guide	1/0/6	.061	2.79 PR

Prime Line Prod.

Bottom Guide - All steel bottom slide guide for bi-fold doors, with 1/2" nylon cap. 1 per card.

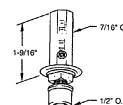

Product No.	Mfg. No.	Description	Order Mult.	Weight	Unit Cost
236640-D	16259	Bi-fold Dr Bottom Guide	1/0/6	.096	2.99 EA

DOOR PARTS

Prime Line Prod.

Bottom Pivot Guide - 3/8" bottom pivot bolt for bi-fold doors. Adjustable steel pivot with nylon base. 2 per card.

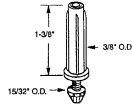

Product No.	Mfg. No.	Description	Order Mult.	Weight	Unit Cost
204994-D	161509	Bottom Pivot Guide	1/0/6	.056	2.29 PR

Prime Line Prod.

Top Pivot Guide - 1/4" x 5-3/4" steel top pin with 3/8" diameter nylon cap. 1 per card.

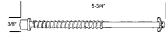

Product No.	Mfg. No.	Description	Order Mult.	Weight	Unit Cost
204404-D	16881	Top Pivot Guide	1/0/6	.125	2.29 EA

Prime Line Prod.

Top Pivot Guide - For use on bi-fold doors. Spring loaded with 7/8" O.D. nylon roller fits 3/8" hole. For use on Kenna Frame and other style doors. 1 per card.

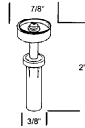

Product No.	Mfg. No.	Description	Order Mult.	Weight	Unit Cost
204811-D	161515	Top Pivot Guide	1/0/6	.081	2.49 PR

Prime Line Prod.

Floor Bracket - Floor bracket for bi-fold doors. 3-1/6" x 1" steel bottom bracket. Complete with 1 nylon holder. 1 per card.

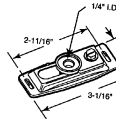

Product No.	Mfg. No.	Description	Order Mult.	Weight	Unit Cost
236357-D	162017	Bi-fold Dr Floor Bracket	1/0/6	.116	3.79 EA

Prime Line Prod.

Bottom Pivot Retainer - 2-7/8" x 7/8" steel bottom bracket for bi-fold doors. Hardware is included. 1 per card.

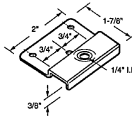

Product No.	Mfg. No.	Description	Order Mult.	Weight	Unit Cost
236462-D	162058	Bottom Pivot Retainer	1/0/6	.180	2.79 EA

HARDWARE

Prime Line Prod.

Top Pivot Bracket - 3/4" x 3/8" nylon top pivot bracket with a 1/4" hole. Complete with wrench. Use with DPI model No. 161111. Use on Alliance style closet doors. 1 per card.

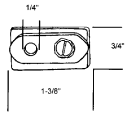

Product No.	Mfg. No.	Description	Order Mult.	Weight	Unit Cost
204366-D	162167	Top Pivot Bracket	1/0/6	.109	2.49 EA

Prime Line Prod.

Bottom Pivot Bracket - 15/16" x 2-15/16" steel bottom bracket with nylon holder complete with wrench. 1 per card.

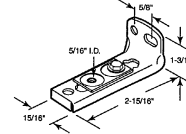

Product No.	Mfg. No.	Description	Order Mult.	Weight	Unit Cost
205028-E	16369	Bottom Pivot Bracket	1/0/6	.171	2.29 EA

Prime Line Prod.

Bottom Jamb Bracket - For use on bi-fold doors. Adjustable steel bracket with nylon bushing and wrench. Primarily used with Johnson hardware. 1 per card.

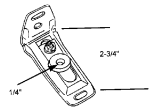

Product No.	Mfg. No.	Description	Order Mult.	Weight	Unit Cost
205419-D	161147	Bi-fold Dr Bottm Bracket	1/0/6	.162	2.99 EA

Prime Line Prod.

Closet Door Hinge - For use on wood bi-fold closet doors. Brass-plated, nonmortise design. 2 per card.

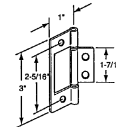

Product No.	Mfg. No.	Description	Order Mult.	Weight	Unit Cost
205397-D	161497	Bi-fold Closet Dr Hinge	1/0/6	.188	2.99 PR

Prime Line Prod.

Bi-fold Closet Hinge - For use on wood bi-fold closet doors. Brass-plated, flag type design. 2 per card.

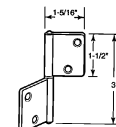

Product No.	Mfg. No.	Description	Order Mult.	Weight	Unit Cost
205400-D	162171	Bi-fold Closet Hinge	1/0/6	.250	3.29 PR

HARDWARE

DOOR PARTS

Prime Line Prod.

Closet Door Knob - Brass-plated knob. 1-9/16" diameter x 3/4" depth. Hardware is included. 1 pair per card.

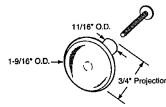

Product No.	Mfg. No.	Description	Order Mult.	Weight	Unit Cost
236667-D	162018	Closet Door Knob	1/0/6	.119	3.29 PR

Prime Line Prod.

Closet Door Knob - Ivory plastic knob. 1-13/16" diameter x 1" depth. Hardware is included. 1 pair per card.

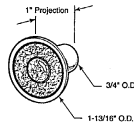

Product No.	Mfg. No.	Description	Order Mult.	Weight	Unit Cost
236675-E	161522	Ivory Plastic Door Knob	1/0/6	.109	1.79 PR

Prime Line Prod.

Bi-Fold Aligner - Steel bi-fold aligner for bi-fold doors. Hardware is included. 1 pair per card.

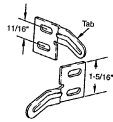

Product No.	Mfg. No.	Description	Order Mult.	Weight	Unit Cost
236446-E	161083	Steel Bi-fold Aligner	1/0/6	.097	1.79 PR

Prime Line Prod.

Double Wheel Hanger - Double wheel pocket door hanger. Adjustable steel top mount bracket. 2 per card.

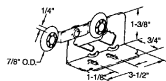

Product No.	Mfg. No.	Description	Order Mult.	Weight	Unit Cost
205265-D	16497	Double Wheel Hanger	1/0/6	.471	8.99 PR

Prime Line Prod.

Pocket Door Floor Guide - Manufactured of white nylon. Use with any single or multiple doors. 1 pair per card.

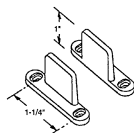

Product No.	Mfg. No.	Description	Order Mult.	Weight	Unit Cost
236659-D	161092	Pocket Door Guide	1/0/6	.063	1.49 PR

Prime Line Prod.

Pocket Door Guide - Single door guide. For use with single sliding closet/wardrobe door. Manufactured of white nylon. 1 per card.

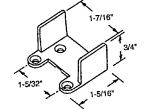

Product No.	Mfg. No.	Description	Order Mult.	Weight	Unit Cost
205370-D	16104	Pocket Door Guide	1/0/6	.040	1.49 EA

Prime Line Prod.

Spline Crank Handle - 11/32" spline crank handle. 3" projection. Made of zinc die-cast, bronze finish. Primarily used on standard casement windows. 1 per card.

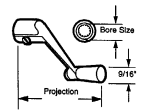

Product No.	Mfg. No.	Description	Order Mult.	Weight	Unit Cost
207411-D	171925	Spline Crank Handle	1/0/6	.158	4.49 EA

Prime Line Prod.

Casement Operator Crank Handle - Aluminum finish. Made of zinc die-cast. 5/16" hole. 2-11/16" projection. 1 per card.

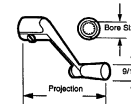

Product No.	Mfg. No.	Description	Order Mult.	Weight	Unit Cost
236233-D	17240	Casmnt Oper Crank Handle	1/0/6	.151	3.29 EA

Prime Line Prod.

Casement Operator Crank Handle - Aluminum-gray finish. 3/4" replacement crank handle. 3/8" hole. 1 per card.

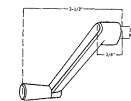

Product No.	Mfg. No.	Description	Order Mult.	Weight	Unit Cost
236209-D	171786	3/8" Oper Crank Handle	1/0/6	.223	4.79 EA

Prime Line Prod.

Spline Crank Handle - 3/8" spline crank handle. For use on all types of window operators with a 3/8" spline zinc die-cast with aluminum finish. 1 per card.

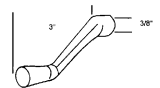

Product No.	Mfg. No.	Description	Order Mult.	Weight	Unit Cost
207446-D	17240-2	Spline Crank Handle	1/0/6	.206	3.29 EA

WINDOW PARTS

Prime Line Prod.

Casement Operator - Left hand. 9" arm. Zinc die-cast. Aluminum finish. All mounting hardware is included. 1 per card.

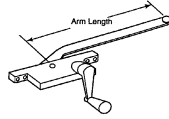

Product No.	Mfg. No.	Description	Order Mult.	Weight	Unit Cost
236187-D	17390-LA	Left Casement Operator	1/0/6	1.158	12.79 EA

Prime Line Prod.

Casement Operator - Right hand. 9" arm. Zinc die-cast. Aluminum finish. All mounting hardware is included. 1 per card.

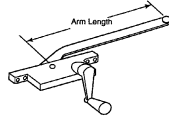

Product No.	Mfg. No.	Description	Order Mult.	Weight	Unit Cost
236179-D	17390-RA	Right Casement Operator	1/0/6	1.158	12.79 EA

Prime Line Prod.

Casement Operator - Left hand. 9" arm. Zinc die-cast. Bronze finish. All mounting hardware is included. 1 per card.



Product No.	Mfg. No.	Description	Order Mult.	Weight	Unit Cost
240397-D	17390-LB	Left Casement Operator	1/0/6	1.000	12.79 EA

Prime Line Prod.

Casement Operator - Right hand. 9" arm. Zinc die-cast bronze finish. All mounting hardware is included. 1 per card.



Product No.	Mfg. No.	Description	Order Mult.	Weight	Unit Cost
240400-D	17390-RB	Right Casement Operator	1/0/6	1.000	12.79 EA

Prime Line Prod.

Universal Jalousie Operator - Aluminum finish with T-crank handle. Fits most all Jalousie windows. All mounting hardware is included. 1 per card.

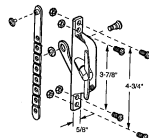

Product No.	Mfg. No.	Description	Order Mult.	Weight	Unit Cost
236314-D	17370	Univ Jalousie Operator	1/0/6	.671	9.99 SET

HARDWARE

Prime Line Prod.

T-Handle Crank - T-handle crank for window operators. 3/8" hole. Zinc die-cast brown finish. Fastener is included. 1 per card. Primary use is on Andersen Windows.

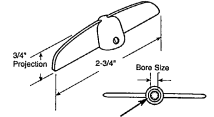

Product No.	Mfg. No.	Description	Order Mult.	Weight	Unit Cost
236160-E	172009	Wind Oper Crank T-handle	1/0/6	.097	2.79 EA

Prime Line Prod.

T-Handle Crank - T-handle crank for window operators. 3/8" hole. Zinc die-cast aluminum finish. Fastener is included. 1 per card. Primary use is on Andersen Windows.

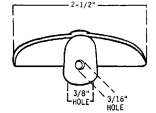

Product No.	Mfg. No.	Description	Order Mult.	Weight	Unit Cost
236152-E	17243-2	Wind Oper Crank T-handle	1/0/6	.095	2.79 EA

Prime Line Prod.

T-Handle Crank - T-handle crank for window operator. 5/16" hole. Zinc die-cast bronze finish. Fastener is included. 1 pair per card.

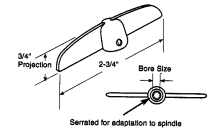

Product No.	Mfg. No.	Description	Order Mult.	Weight	Unit Cost
236144-E	17243-B	Wind Oper Crank T-handle	1/0/6	.099	2.79 EA

Prime Line Prod.

T-Handle Crank - T-handle crank for window operator. 5/16" hole. Zinc die-cast aluminum finish. Fastener is included. 1 per card.

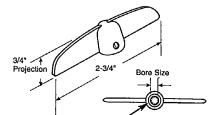

Product No.	Mfg. No.	Description	Order Mult.	Weight	Unit Cost
236136-E	17243	Wind Oper Crank T-handle	1/0/6	.098	2.29 EA

Prime Line Prod.

Casement Operator Crank Handle - Aluminum finish. 1-3/4" replacement crank handle. 5/16" hole. Contents: 1 handle. Use: Mobile home.

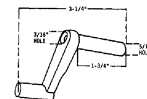

Product No.	Mfg. No.	Description	Order Mult.	Weight	Unit Cost
236306-E	22252	1-3/4" Case Crank Handle	1/0/6	.137	2.79 EA

HARDWARE

Prime Line Prod.

Casement Operator Crank Handle - Aluminum finish. 1" replacement crank handle. 5/16" hole. Contents: 1 handle. Use: Mobile home.

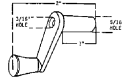

Product No.	Mfg. No.	Description	Order Mult.	Weight	Unit Cost
236276-D	22251	Casmnt Oper Crank Handle	1/0/6	.097	2.29 EA

Prime Line Prod.

Casement Crank Extension - 2" replacement crank extension. 5/16" hole. Contents: 1 extension. Use: Mobile home.

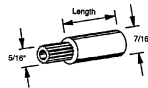

Product No.	Mfg. No.	Description	Order Mult.	Weight	Unit Cost
236225-E	22250-C	Casement Crank Extension	1/0/6	.090	2.29 EA

NOTE 1: Hand determined by window hinge location from **outside** home looking **in**.

Prime Line Prod.

Shelf Supports - Made of clear butyrate. 8 per card.

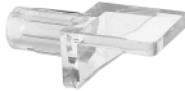

Product No.	Mfg. No.	Description	Order Mult.	Weight	Unit Cost
207985-D	242152	Clear Shelf Support	1/0/6	.026	2.29 PK

Prime Line Prod.

Shelf Supports - Made of clear butyrate. 8 per card.



Product No.	Mfg. No.	Description	Order Mult.	Weight	Unit Cost
207993-D	242155	Clear Shelf Support	1/0/6	.026	2.29 PK
208027-D	242156	Clear Shelf Support	1/0/6	.026	1.79 PK

Prime Line Prod.

Shelf Supports - Made of beige high-impact styrene. 8 per card.

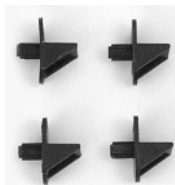

Product No.	Mfg. No.	Description	Order Mult.	Weight	Unit Cost
208035-D	242154	Brn Shelf Support	1/0/6	.027	2.29 PK

WINDOW PARTS

Prime Line Prod.

Shelf Supports - Made of high-impact styrene. 12 per package.

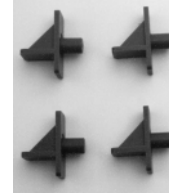

Product No.	Mfg. No.	Description	Order Mult.	Weight	Unit Cost
208043-D	241945	Brown	1/0/6	.027	2.29 EA
208051-D	242157	Beige	1/0/6	.027	2.29 PK
259403-D	241966	Almond	1/0/6	.085	2.29 CD
259411-D	241946	Clear	1/0/6	.083	2.29 CD
259438-D	242400	White	1/0/6	.093	1.99 CD

Prime Line Prod.

Shelf Supports - Fits imported entertainment centers. Shelf supports are made of clear plastic. 8 per card.



Product No.	Mfg. No.	Description	Order Mult.	Weight	Unit Cost
208094-D	242153	Clear Shelf Support	1/0/6	.026	1.79 PK

Prime Line Prod.

Shelf Supports - Metal with nickel finish. 7/8" long, 5mm diameter. 8 per package.



Product No.	Mfg. No.	Description	Order Mult.	Weight	Unit Cost
208108-D	242158	Chrome Shelf Support	1/0/6	.028	1.49 PK

Prime Line Prod.

Shelf Supports - Metal with brass finish. 7/8" long, 5mm diameter. 8 per package.



Product No.	Mfg. No.	Description	Order Mult.	Weight	Unit Cost
208124-D	243388	Brass Shelf Support	1/0/6	.028	1.49 PK

DOOR PARTS

Prime Line Prod.

Shelf Supports - Plastic support stem is 3mm. Color: Clear with metal stem. 8 per bag.

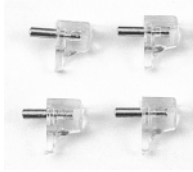

Product No.	Mfg. No.	Description	Order Mult.	Weight	Unit Cost
208132-D	242159	Clear Shelf Support	1/0/6	.028	1.79 PK

Prime Line Prod.

Patio Door Roller - 1" diameter steel patio door roller only, with axle. 1 pair per card.

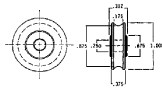

Product No.	Mfg. No.	Description	Order Mult.	Weight	Unit Cost
235911-D	111894	Patio Door Roller	1/0/6	.156	4.99 EA

Prime Line Prod.

Patio Door Roller - 1-1/4" diameter steel patio door roller only, with axle. 1 pair per card.

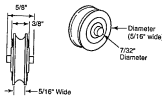

Product No.	Mfg. No.	Description	Order Mult.	Weight	Unit Cost
235938-D	131972	Patio Door Roller	1/0/6	.201	5.79 EA

Prime Line Prod.

Patio Door Roller - 1-1/2" diameter steel patio door roller only, with axle. 1 pair per card.

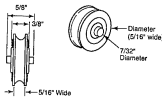

Product No.	Mfg. No.	Description	Order Mult.	Weight	Unit Cost
235946-D	131905	Patio Door Roller	1/0/6	.285	6.99 EA

Prime Line Prod.

Patio Door Roller - 1-1/4" diameter steel roller and housing. 1 per card. For sliding glass doors. Heavy-duty adjustable steel housing. Used by Fleetwood and other manufacturers.

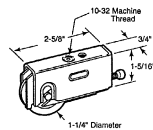

Product No.	Mfg. No.	Description	Order Mult.	Weight	Unit Cost
235954-D	131476	Patio Door Roller	1/0/6	.614	5.79 EA

HARDWARE

Prime Line Prod.

Patio Door Roller - 1-1/2" diameter steel roller and housing. 1 per card. For sliding glass doors. Heavy-duty adjustable steel housing. Used by Air Control, Howmet, Krestmark, and other manufacturers.

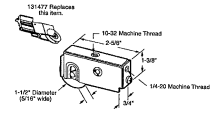

Product No.	Mfg. No.	Description	Order Mult.	Weight	Unit Cost
214039-D	131477	Patio Door Roller	1/0/6	.350	4.79 EA

Prime Line Prod.

Patio Roller Assembly - Steel roller assembly. For use on sliding glass doors. 1-1/4" steel ball bearing roller. Heavy adjustable metal housing. Used by Crossly and other door manufacturers. 1 per card.

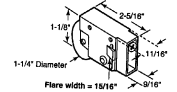

Product No.	Mfg. No.	Description	Order Mult.	Weight	Unit Cost
206679-D	131973	Patio Door Roller	1/0/6	.375	6.99 EA

Wright Prod.

Patio Door Hardware Set - Flush-mounted. Fits into a machined pocket in the door stile. Projection in only 1/16" on inside and outside of patio door. Complete mounting instructions on the skin pack card. Replaces most sets of this style and is reversible for right or left hand application. For 1" to 1-1/4" thick doors. 6-1/2" between attaching screws. Zamac-steel.



Product No.	Mfg. No.	Description	Order Mult.	Weight	Unit Cost
213815-D	V1195	Patio Door Hardware Set	1/0/6	1.050	13.99 EA

Prime Line Prod.

Patio Door Pull - 1-piece hardwood handle with a 1-piece black finish die-casted body. 6-1/2" center to center screw holes. 1 per card.



Product No.	Mfg. No.	Description	Order Mult.	Weight	Unit Cost
206784-D	142268	Patio Door Pull	1/0/6	.500	7.29 EA

Prime Line Prod.

Patio Locking Handle Assembly - For use on sliding glass doors. Aluminum construction with solid wood handle. 3-15/16" center to center distance. Complete with striker and mounting screws. Inside lock. Use model No. 1505 cylinder for outside key lock. 1 set per card.



Product No.	Mfg. No.	Description	Order Mult.	Weight	Unit Cost
206806-D	14186	Patio Locking Dr Assembly	1/0/4	.887	17.49 EA

Prime Line Prod.

Patio Door Striker - 1/2" wide chrome strikers with hardware included. 1 per card. Popular style with many door manufacturers.

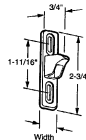

Product No.	Mfg. No.	Description	Order Mult.	Weight	Unit Cost
236063-D	14504	Patio Door Striker	1/0/6	.092	2.29 EA

Prime Line Prod.

Patio Door Strike - Die-casted strike with screws. Used by many different sliding glass door manufacturers. 2 per card.

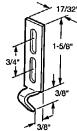

Product No.	Mfg. No.	Description	Order Mult.	Weight	Unit Cost
206814-D	151955	Patio Door Strike	1/0/6	.125	2.99 PR

Prime Line Prod.

Patio Lock Cylinder - Brass key cylinder. 2 keys. 1 per card.

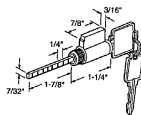

Product No.	Mfg. No.	Description	Order Mult.	Weight	Unit Cost
206865-D	1505	Patio Lock Cylinder	1/0/6	.156	8.29 EA

Prime Line Prod.

Patio Lock Cylinder - Wafer cylinder. Use with model No. 956 and 962. 2 keys. 1 per card.

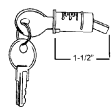

Product No.	Mfg. No.	Description	Order Mult.	Weight	Unit Cost
206849-D	152179	Patio Lock Cylinder	1/0/6	.125	3.49 EA

Prime Line Prod.

Security Pin Lock - Steel finish patio door security pin. Hardware included. 1 per card.

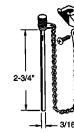

Product No.	Mfg. No.	Description	Order Mult.	Weight	Unit Cost
236098-D	15301	Patio Security Lock	1/0/6	.100	1.79 EA

Prime Line Prod.

Mortise Patio Lock - Patio door mortise lock. 45° hub. 1 per card.

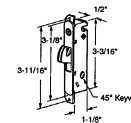

Product No.	Mfg. No.	Description	Order Mult.	Weight	Unit Cost
207101-D	15410-F	Patio Door Mortise Lock	1/0/6	.250	10.99 EA

Prime Line Prod.

Mortise Patio Lock - Patio door mortise lock 45° hub with mounting bracket. 1 per card.

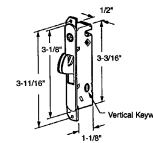

Product No.	Mfg. No.	Description	Order Mult.	Weight	Unit Cost
207241-D	153554	Mortise Patio Lock	1/0/6	.437	13.79 EA

Prime Line Prod.

Strike With Screws - 3/16" offset die-cast striker with screws. For screen doors. 1 per card.

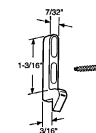

Product No.	Mfg. No.	Description	Order Mult.	Weight	Unit Cost
206652-E	1207-M	Screen Door Strike	1/0/6	.063	1.29 EA

Prime Line Prod.

Striker With Screws - 1/4" offset steel strike with screws. For screen doors. 1 per card.

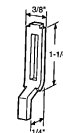

Product No.	Mfg. No.	Description	Order Mult.	Weight	Unit Cost
206660-D	121090	Screen Door Strike	1/0/6	.039	.99 EA

DOOR PARTS

HARDWARE

Prime Line Prod.

Screen Door Roller - 1" nylon screen door roller. Nylon housing with nylon roller with ball bearing. 1 pair per card.

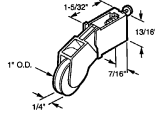

Product No.	Mfg. No.	Description	Order Mult.	Weight	Unit Cost
235857-D	111370	Screen Door Roller	1/0/6	.106	5.29 PR

Prime Line Prod.

Screen Door Roller - Aluminum screen door roller with 1" nylon roller. 1 pair per card.

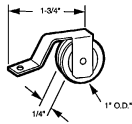

Product No.	Mfg. No.	Description	Order Mult.	Weight	Unit Cost
235903-D	11960	Nylon	1/0/6	.060	2.49 PR
257664-D	11960-B	Steel ball bearing	1/0/6	.108	3.99 CD

Prime Line Prod.

Screen Door Roller - Screen door roller with 2-1/2" spring and 1" nylon roller. 1 pair per card. Nylon.

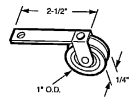

Product No.	Mfg. No.	Description	Order Mult.	Weight	Unit Cost
235997-D	1186	Screen Door Roller	1/0/6	.053	2.49 PR

Prime Line Prod.

1" Steel Screen Door Roller - For use on sliding screen doors. Steel ball bearings and roller. Adjustable steel housing. May be used as top or bottom roller. 1 pair per card.

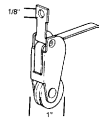

Product No.	Mfg. No.	Description	Order Mult.	Weight	Unit Cost
206954-D	11749	1" Steel Scrn Dr Roller	1/0/6	.063	5.79 PR

Prime Line Prod.

Screen Door Roller - Screen door roller with 1-1/4" nylon roller and aluminum assembly. 1 pair per card.

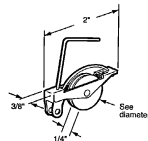

Product No.	Mfg. No.	Description	Order Mult.	Weight	Unit Cost
236039-D	11118	Screen Door Roller	1/0/6	.091	3.49 PR

Prime Line Prod.

Roller Assembly - Aluminum screen door roller with 1" nylon roller. Fits Academy doors. 1 pair per card.

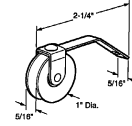

Product No.	Mfg. No.	Description	Order Mult.	Weight	Unit Cost
235881-D	11666	Nylon	1/0/6	.059	2.49 PR
257648-D	11666-B	Steel ball bearing	1/0/6	.108	3.99 CD

Prime Line Prod.

Screen Door Roller - Screen door roller with 1" nylon roller and aluminum assembly. 1 pair per card.

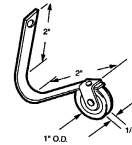

Product No.	Mfg. No.	Description	Order Mult.	Weight	Unit Cost
236004-D	11597	Screen Door Roller	1/0/6	.076	3.29 PR

Prime Line Prod.

Screen Door Roller - Screen door roller with 1" nylon roller and aluminum assembly. 1 pair per card.

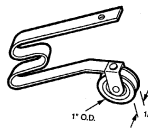

Product No.	Mfg. No.	Description	Order Mult.	Weight	Unit Cost
236012-D	1109	Nylon	1/0/6	.083	2.79 PR
236101-D	1109-B	Steel ball bearing	1/0/6	.126	4.79 PR
257583-D	111766	Nylon ball bearing	1/0/6	.113	4.49 CD

Prime Line Prod.

Screen Door Roller - Screen door roller with 1" nylon roller and aluminum assembly. 2 per card.

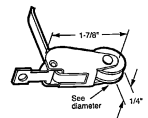

Product No.	Mfg. No.	Description	Order Mult.	Weight	Unit Cost
236020-D	11314	Screen Door Roller	1/0/6	.088	3.79 PR

Prime Line Prod.

Screen Door Pull - Screen door pull with hardware included. Plastic with steel latch assembly. Nonhanded. Mortise installation. Vertical sliding activator. Fits on *Jim Walters* sliding roll-formed screen door. 1 per card.

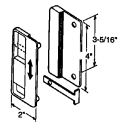

Product No.	Mfg. No.	Description	Order Mult.	Weight	Unit Cost
236047-D	121803	Screen Door Pull	1/0/6	.116	4.49 EA

Some products shown may need to be special ordered for your convenience!

HARDWARE

Prime Line Prod.

Screen Door Handle - Screen door Pull. Black. Plastic with steel latch assembly. Nonhanded. Mortise installation that is used by several manufacturers. 1 per card.

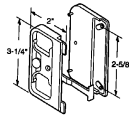

Product No.	Mfg. No.	Description	Order Mult.	Weight	Unit Cost
236055-D	121740	Screen Door Handle	1/0/6	.145	4.49 EA

Prime Line Prod.

Nylon Roller - For use on sliding screen doors. 1" diameter nylon roller with 1/8" center groove. Includes axle and bolt. 1 pair per card.

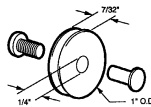

Product No.	Mfg. No.	Description	Order Mult.	Weight	Unit Cost
206636-D	11116	Screen Door Roller	1/0/6	.004	1.99 PR

Prime Line Prod.

1" Adjustable Roller Assembly - For use on sliding screen doors. Aluminum and nylon construction. Fully adjustable. May be used as top or bottom roller. Used on Columbia and other types of doors. 2 per card. Nylon.

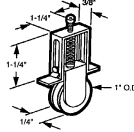

Product No.	Mfg. No.	Description	Order Mult.	Weight	Unit Cost
207020-D	11657	Screen Door Roller	1/0/6	.056	4.29 PR

Prime Line Prod.

Screen Door Roller - 1" adjustable roller assembly. For use on sliding screen doors, nylon ball bearing roller. Adjustable design. Primarily used on Academy Uni-fit doors. 2 per card.

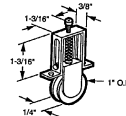

Product No.	Mfg. No.	Description	Order Mult.	Weight	Unit Cost
206687-D	11434	Screen Door Roller	1/0/6	.050	4.29 PR

Prime Line Prod.

Plastic Screen Door Pull - Universal black plastic pull handle. Replaces most types of screen door handles. 2-screw installation. Includes mounting hardware. 1 per package.

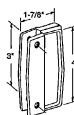

Product No.	Mfg. No.	Description	Order Mult.	Weight	Unit Cost
207012-D	12209	Screen Door Pull	1/0/6	.087	2.29 PR

Prime Line Prod.

1" Tension Roller Spring - For use on sliding screen doors 1" nylon roller with 1/4" center groove. High-tension steel spring. For use on a variety of sliding screen doors. 2 pair per card.

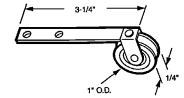

Product No.	Mfg. No.	Description	Order Mult.	Weight	Unit Cost
206628-D	1147	Screen Door Roller	1/0/6	.050	3.29 PR

Wright Prod.

Strike Plate - For all types of storm and screen door locks. Packed individually on a display card.



Product No.	Mfg. No.	Description	Order Mult.	Weight	Unit Cost
208144-D	V777ST	Aluminum	1/0/100	.008	1.99 EA
238451-D	V777STBL	Black	1/0/10	.075	2.29 EA

Wright Prod.

Rigid Strike Plate - 1/4", 3/8", 1/2" high strike plates with slotted holes for universal replacement. Packed with installation screws. Zinc finish.



Product No.	Mfg. No.	Description	Order Mult.	Weight	Unit Cost
203610-D	V333ST	Rigid Strike	1/0/10	.100	2.49 EA

Wright Prod.

Colonial Push-Button Latch - Authentic colonial hammered finish. For outswinging wood or metal doors. Fits doors 1" to 1-1/4" thick. *No Lock Out* feature. Installs with only three 1/4" holes. Backset from jamb 13/16". Installation hole spacing 1-3/4". Key cylinder thumb buttons available to convert latch to key locking set. Carded.



Product No.	Mfg. No.	Description	Order Mult.	Weight	Unit Cost
209562-D	VC333BL	Colonial Pushbutton Latch	1/0/6	.650	9.49 EA

DOOR PARTS

Wright Prod.

Key Lock Thumb Button Assembly - Converts model No. V333 and VC333BL push-button latches to key locking set. Nickel finish. Skin packed.



Product No.	Mfg. No.	Description	Order Mult.	Weight	Unit Cost
211782-D	V3	Key Lock Thumb Button	1/0/5	.150	7.99 EA

Wright Prod.

Push-Button Latch - For outswinging wood or metal doors 1" to 1-1/4" thick. *No Lock Out* feature. Installs with only three 5/16" holes. Backset from jamb 13/16". Installation hole spacing 1-3/4". Key cylinder thumb buttons available to convert latch to key locking set. Replacement covers furnished. Skin packed for display.



Product No.	Mfg. No.	Description	Order Mult.	Weight	Unit Cost
229452-D	V333	Zamac aluminum	1/0/6	.650	9.49 EA
235407-D	V333WH	White	1/0/6	.660	9.49 EA
203629-D	V333BL	Black	1/0/6	.660	9.49 EA

Wright Prod.

Push-Button Key Lock - For outswinging wood or metal doors. Fits doors 1" to 1-1/4" thick. Installs with only three 1/4" holes. Installation hole spacing 1-3/4". Contains 2 sizes of strikes and shims to provide adjustment for latching. Has *No Lock Out* feature. Exterior has key lock for extra security.



Product No.	Mfg. No.	Description	Order Mult.	Weight	Unit Cost
213179-D	VK333X3	Aluminum	1/0/6	.700	16.99 EA

Wright Prod.

Door Catch - Steel. Extruded bearing in housing and rocker arm assures smooth action and long service. Prelubricated. Cadmium finish. Skin packaged for display.



Product No.	Mfg. No.	Description	Order Mult.	Weight	Unit Cost
208019-D	V12	Steel Door Catch	1/0/5	.175	4.29 EA

HARDWARE

Wright Prod.

Snap Fastener - Holds storm windows, screens, combination door panels and has many other uses. Snap plate made of tempered spring steel. Spring tension holds window firmly against frame. Does not mar painted surfaces by rotating on them. Storm windows and screens easily removed by snapping fastener back to open position. Poly bag holds 4 fasteners.



Product No.	Mfg. No.	Description	Order Mult.	Weight	Unit Cost
238147-D	#P29	Snap Fastener	1/0/100	.196	2.79 BG

Wright Prod.

Snap Fastener - Holds storm windows, screens, combination door panels and has many other uses. Snap plate made of tempered spring steel. Spring tension holds window firmly against frame. Does not mar painted surfaces by rotating on them. Storm windows and screens easily removed by snapping fastener back to open position. Display card holds 4 fasteners.



Product No.	Mfg. No.	Description	Order Mult.	Weight	Unit Cost
217349-D	V29	Snap Fasteners	1/0/10	.140	3.49 CD

Wright Prod.

Door Stop Spring Chain - Built to absorb shock and protect against wind damage to door. Heavy spring wire and bull dog chain give maximum protection. Chain can be readily detached from bracket to allow full opening of door. Skin packed for display.



Product No.	Mfg. No.	Description	Order Mult.	Weight	Unit Cost
208741-D	V11	Zinc	1/0/5	.425	4.29 EA
203726-D	V11BL	Black	1/0/5	.400	4.59 EA

Century Spring

Door Springs - Steel wire. Double loop ends with screw hook for attaching. Cadmium finish.



Product No.	Mfg. No.	Description	Order Mult.	Weight	Unit Cost
207430-E	CS3	23/64" outside diameter, 16-3/8" long	10/0/100	.020	1.79 EA
207458-D	CS4	3/8" outside diameter, 16-3/8" long	10/0/100	.195	1.99 EA
207476-D	CS5	13/32" outside diameter, 16-3/8" long	10/0/100	.030	2.29 EA
207494-D	CS6	1/2" outside diameter, 16-3/8" long	10/0/100	.030	2.29 EA
207519-D	CS7	9/16" outside diameter, 16-3/8" long	10/0/100	.040	2.79 EA

HARDWARE

DOOR PARTS

National Mfg.

Adjustable Door And Gate Spring - Rust-resistant tension adjusted by threaded shaft. Zinc. V-pac.

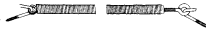

Product No.	Mfg. No.	Description	Order Mult.	Weight	Unit Cost
202088-C	N172114	Zn Adj Door Spring	1/10/30	.351	3.79 PK

Wright Prod.

Universal Casement Operator - Designed for outswinging metal or wood casement windows. Special adapter brackets allow replacement on either metal or wood casements. Handling determined from the inside facing window. Hinge determines hand. Will replace most standard crank-type operators. Case-hardened worm gear and stud assure long service. Operator arm is rustproofed steel. Zinc and steel. Bronze finish.



Product No.	Mfg. No.	Description	Order Mult.	Weight	Unit Cost
231751-D	V80R9BZ	Casement Operator	1/0/5	1.100	15.99 EA
231760-D	V80L9BZ	Casement Operator	1/0/5	1.100	15.99 EA

Prime Line Prod.

Casement Locking Handle - Extra-strong casting for long life. Replaces most lock fasteners of this type. Made of Zamac and steel. Easily installed with a screwdriver. Bronze finish.



Product No.	Mfg. No.	Description	Order Mult.	Weight	Unit Cost
231779-D	1760-A-LB	Casement Locking Handle	1/0/6	.276	4.79 EA
231788-D	1760-A-RB	Casement Locking Handle	1/0/6	.276	4.79 EA

Wright Prod.

Casement Operator Handle - Extra-strong casting for long life. Replaces most broken or worn out casement operator handles. Made of Zamac bronze. Bronze finish. Easily installed with screwdriver.



Product No.	Mfg. No.	Description	Order Mult.	Weight	Unit Cost
217571-D	V82BZ	Casement Operator Handle	1/0/5	.088	4.99 EA

Wright Prod.

Easy Touch Storm And Screen Door Closer - Door closer features are; bracket cover, hides exposed screws or connector pins. Color matched bracket cover *snaps* over jamb bracket. Integrated, easy to dial, provides positive *hold open* locking action. New regulating knob for *tool free* latching speed.



Product No.	Mfg. No.	Description	Order Mult.	Weight	Unit Cost
253529-D	V2000CH	Champagne	1/0/6	1.436	13.99 EA
253537-D	V2000BL	Black	1/0/6	1.436	13.99 EA
253545-D	V2000WH	White	1/0/6	1.433	13.99 EA

Wright Prod.

Door Closer - For wood or metal screen storm, combination or light interior doors. Controlled power feature bypass on closer tube and multiple-hole door bracket allow section of proper closing power at latching point. Replacement cover plate included for neat replacement of most broken or worn out closers. Designed for outswinging doors. Steel material.



Product No.	Mfg. No.	Description	Order Mult.	Weight	Unit Cost
209376-C	V920	Aluminum	1/0/6	1.300	9.79 EA
234320-C	V920BL	Black	1/0/6	1.313	9.79 EA
235415-C	V920WH	White	1/0/6	1.300	9.79 EA

Wright Prod.

Combination Door Hardware Set - A complete set containing all necessary hardware for installing a wood or metal combination door, 1" to 1-1/4" thick. Contains the model No. 333 push-button latch, model No. 1020 door closer and model No. 11 spring and chain door retainer.



Product No.	Mfg. No.	Description	Order Mult.	Weight	Unit Cost
239076-D	#S40	Combo Door Hardware Set	1/0/5	2.460	19.49 EA

Wright Prod.

Combination Door Hardware Set - A complete set containing all necessary hardware for installing a wood or metal combination door, 1" to 1-1/4" thick. Contains the model No. C333 colonial push-button latch, model No. 1020 door closer and model No. 11 spring and chain door retainer.



Product No.	Mfg. No.	Description	Order Mult.	Weight	Unit Cost
239067-D	VS50BL	Combo Door Hardware Set	1/0/5	2.460	15.99 EA

National Mfg.

Screen And Storm Sash Hanger - Hot-rolled steel. Zinc finish. Consists of 1 pair top hooks and 1 pair bottom hangers and screws in a visual pack.



Product No.	Mfg. No.	Description	Order Mult.	Weight	Unit Cost
207822-C	N106682	Screen Door Hangers	1/5/50	.225	2.29 PK

DOOR PARTS

National Mfg.

Snap Fasteners - Spring steel base, cold-rolled steel center piece. Zinc finish. Makes window removal easy. Will not damage painted surfaces. Packed 4 in a visual pack with screws.

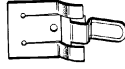

Product No.	Mfg. No.	Description	Order Mult.	Weight	Unit Cost
242438-C	N192179	Zinc Snap Fastener	1/0/5	.150	2.99 PK

National Mfg.

Half Turn Button - Formed so only contact on frame is at circular base around screw hole. Packed 4 in a visual pack with screws.



Product No.	Mfg. No.	Description	Order Mult.	Weight	Unit Cost
223378-C	N106906	4pk Half Turn Button	1/5/50	.125	1.49 PK

National Mfg.

Turn Button - Formed so the only point of contact on the window frame is at the circular base around the screw hole. The wings are raised slightly above the base and edges are curved so that in turning it will not gouge the wood. 1-3/4" zinc finish. Packed 4 in a visual pack with screws.



Product No.	Mfg. No.	Description	Order Mult.	Weight	Unit Cost
207859-D	N106815	4pk Zinc Turn Button	1/5/50	.143	1.79 PK

National Mfg.

Screen And Storm Door Set - Zinc. Designed for full-surface, half-surface, half-mortise, or offset application. Set consists of: 1 pair model No. 129 loose pin hinges, 3" x 2-1/2"; 1 each model No. 2000 zinc hook and eye, 2-1/2", model No. 200 door pull and model No. 76 spring with hooks.



Product No.	Mfg. No.	Description	Order Mult.	Weight	Unit Cost
218507-C	N107425	Screen/storm Door Set	1/5/20	.880	7.79 PK

National Mfg.

Screen Door Hinge - Button tip, loose pin, unwaged, reversible hinge. Use full-surface, half-surface, half-mortise or for offset where door and jamb are not flush. Screw holes countersunk on both sides of each leaf. Size: 3" x 2-1/2". Packed 1 pair in visual bag with 3/4" x 8 flat head screws. BakEnamel brass and zinc finishes.

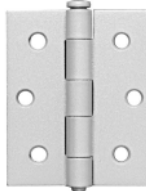

Product No.	Mfg. No.	Description	Order Mult.	Weight	Unit Cost
208279-C	N115477	Brs Screen Door Hinge	1/5/50	.667	5.79 PK
229256-C	N115519	Zinc Screen Door Hinge	1/5/50	.588	4.79 PK

HARDWARE

National Mfg.

Screen Door Hinge - Solid brass. Polished brass finish. Bottom-tip, loose pin for wood screen and storm doors, utility and cabinet doors. Surface mounted, no mortise or cutout required. Screw holes countersunk on both sides of each leaf. Size: 3" x 2-1/2". 1 per card.



Product No.	Mfg. No.	Description	Order Mult.	Weight	Unit Cost
206752-D	N220053	Sb/pb Screen Door Hinge	1/5/25	.340	9.79 PK

National Mfg.

Screen Door Turnbuckle - Use to brace, raise, or eliminate sagging on screen or storm doors. Threaded steel rods will not rust to aluminum turnbuckle body. Steel construction with zinc finish. Packed in visual-pac with screws.



Product No.	Mfg. No.	Description	Order Mult.	Weight	Unit Cost
207966-C	N117564	42" long	1/0/5	.319	4.49 PK
234071-C	N117580	50" long	1/0/5	.700	5.79 PK

National Mfg.

Screen Door Catch - Steel frame and spring, rubber rollers. Zinc-plated. Spring action catch designed to hold doors firmly closed. Packed 1 in a visual pack with screws.



Product No.	Mfg. No.	Description	Order Mult.	Weight	Unit Cost
242454-C	N192773	Screen Door Catch	1/3/30	.283	3.99 EA

Prime Line Prod.

Plastic Screen And Storm Door Grilles - Molded plastic grille fits most swinging door applications. Helps prevent screen or glass damage. Easy-to-install. Installation screws included in poly bagged package.



Product No.	Mfg. No.	Description	Order Mult.	Weight	Unit Cost
219487-D	PL-15517	White	1/0/6	.261	15.49 EA
219479-D	PL-15515	Gray	1/0/6	.261	15.49 EA

Prime Line Prod.

Door Grille - Molded of high-quality, rugged polymer plastic. Resists fading, cracking, and chipping. Suitable for use in all climates, and is maintenance free. Polymer grille is 20" in height and installs on doors 30", 32", and 36" wide. Cut to size for 30" and 32" doors with a hacksaw. Dark brown.



Product No.	Mfg. No.	Description	Order Mult.	Weight	Unit Cost
251429-D	PL15516	Dark Brown Door Grille	1/0/6	1.917	15.49 EA

Prime Line Prod.

Door Grille - 24" high. Fits doors 30", 32", and 36" wide. Manufactured of aluminum. Cut to size for 30" and 32" doors with a hacksaw.



Product No.	Mfg. No.	Description	Order Mult.	Weight	Unit Cost
209783-D	PL-15930	Mill	1/0/6	2.250	24.49 EA
209775-D	PL15933	White	1/0/6	2.250	25.49 EA
251437-D	PL15934	Dark brown	1/0/6	2.250	25.49 EA

M-D Building Products

Door Grille - 8" high. Aluminum. Satin finish.



Product No.	Mfg. No.	Description	Order Mult.	Weight	Unit Cost
212504-D	33167	32" wide	0/0/3	1.173	24.99 EA
212520-D	33209	36" wide	0/0/3	1.241	24.99 EA

M-D Building Products

Door Grille - Extruded aluminum. 15" high. Satin (aluminum) finish.



Product No.	Mfg. No.	Description	Order Mult.	Weight	Unit Cost
212539-D	33241	32" wide	0/0/3	2.041	29.49 EA

M-D Building Products

Door Grille - Expanded aluminum. Push grille. 19" high.



Product No.	Mfg. No.	Description	Order Mult.	Weight	Unit Cost
212555-D	33282	32" wide, satin (aluminum)	0/0/3	1.996	31.49 EA
212563-D	33340	36" wide, satin (aluminum)	0/0/3	2.186	33.99 EA
212571-D	33381	36" wide, duratone bronze	0/0/3	2.401	39.49 EA

Prime Line Prod.

Patio Door Grille - 36" wide. Sturdy, extruded aluminum frame holds panel of expanded aluminum. Easily mounted on sliding screen door.

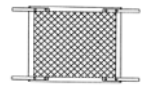

Product No.	Mfg. No.	Description	Order Mult.	Weight	Unit Cost
212598-D	PL15935	Mill finish (aluminum)	0/0/3	3.067	47.49 EA
251445-D	PL15937	White finish	0/0/3	3.067	37.49 EA
212628-D	PL15938	Bronze finish	0/0/3	3.067	52.99 EA

Amerock Corp.

Shenandoah Knob - 1-1/4" diameter. 15/16" high.



Product No.	Mfg. No.	Description	Order Mult.	Weight	Unit Cost
237760-D	BP710-26	Polished chromium (26) finish	1/0/25	.070	3.49 EA
244732-D	BP710-3	Polished brass (3) finish	1/0/25	.090	3.79 EA

Amerock Corp.

Porcelain Knob - 1-1/4" diameter. 1-3/16" high.



Product No.	Mfg. No.	Description	Order Mult.	Weight	Unit Cost
216216-C	BP725-OM	Oatmeal (OM) finish, 1 per pack	1/0/25	.150	3.49 EA

KNOBBS/PULLS

HARDWARE

Amerock Corp.

Earhtone Knobs - 1-3/8" diameter. 13/16" high.



Product No.	Mfg. No.	Description	Order Mult.	Weight	Unit Cost
207751-C	BP725A-AM	Almond (AL) finish	1/0/25	.150	3.49 EA
207261-C	BP725A-CR	Crackle (CR) finish	1/0/25	.150	3.49 EA

Amerock Corp.

Traditional Classics - Round knob.



Product No.	Mfg. No.	Description	Order Mult.	Weight	Unit Cost
252549-D	BP771-WI	1-1/4" diameter, 1-1/16" high, wrought iron (WI) finish	1/0/25	.192	4.79 EA
209312-C	BP771-RBZ	1-1/4" diameter, 1-1/16" projection, rustic bronze (RBZ) finish	1/0/25	.190	4.49 EA

Amerock Corp.

Plastic Knob - 1-1/4" diameter. 15/16" high.



Product No.	Mfg. No.	Description	Order Mult.	Weight	Unit Cost
200905-D	BP802-PW	White plastic (PW) finish	1/0/25	.050	1.49 EA
244648-D	BP802-PBK	Black plastic (PBK) finish	1/0/25	.030	1.49 EA

Amerock Corp.

Plastic Pull - 3-5/16" with 3" center.



Product No.	Mfg. No.	Description	Order Mult.	Weight	Unit Cost
200875-C	BP803-PW	White plastic (PW) finish	1/0/25	.050	1.99 EA
244643-C	BP803-PBK	Black plastic (PBK) finish	1/0/25	.040	1.99 EA

Amerock Corp.

Wood Knob - Round 1-1/4" diameter. 3/4" high. 2 per package. Wood (WD) finish.

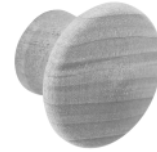

Product No.	Mfg. No.	Description	Order Mult.	Weight	Unit Cost
200859-C	BP811-WD	1-1/4" Wood Knob	1/0/25	.040	1.29 PKG

Amerock Corp.

Wood Knob - Round, 1" diameter. 13/16" high. 2 per package. Wood (WD) finish.



Product No.	Mfg. No.	Description	Order Mult.	Weight	Unit Cost
206495-D	BP812-WD	1" Rnd Wood Knob	1/0/25	.041	1.29 PKG

Amerock Corp.

Wood Knob - Round 1-1/2" diameter. 7/8" high. 2 per package. Wood (WD) finish.



Product No.	Mfg. No.	Description	Order Mult.	Weight	Unit Cost
219891-D	BP813-WD	1-1/2" Rnd Wood Knob	1/0/25	.080	1.49 PKG

Amerock Corp.

Wood Knob - Round, 2" diameter. 1" high. 2 per package. Wood (WD) finish.



Product No.	Mfg. No.	Description	Order Mult.	Weight	Unit Cost
206618-C	BP814-WD	2" Rnd Wood Knob	1/0/25	.099	1.99 PKG

HARDWARE

HARDWARE

KNOB/PULLS

Amerock Corp.

Legacy Polished Brass Knob And Backplate - 1-1/8" diameter backplate. 1-3/16" diameter. 1-1/2" high. Polished brass (3) finish.



Product No.	Mfg. No.	Description	Order Mult.	Weight	Unit Cost
207323-C	BP830C-3	1-1/8" Pb Knob/backplate	1/0/10	.220	8.79 SET

Amerock Corp.

Anniversary Knob - Commemorative series. 1-3/16" diameter.



Product No.	Mfg. No.	Description	Order Mult.	Weight	Unit Cost
200840-C	BP853-O74	Sterling brass (074) finish	1/0/25	.100	5.79 EA
225681-D	BP853-G9	Sterling nickel (G9) finish	1/0/25	.100	6.49 EA
237779-D	BP853-26	Chrome (26) finish	1/0/25	.100	5.29 EA

Amerock Corp.

Anniversary Pull - Commemorative series. 4-1/4" with 3" center.



Product No.	Mfg. No.	Description	Order Mult.	Weight	Unit Cost
200832-C	BP854-O74	Sterling brass (074) finish	1/0/25	.080	6.49 EA
225703-D	BP854-G9	Sterling nickel (G9) finish	1/0/25	.080	6.99 EA

Amerock Corp.

Furniture Trim Knob - Porcelain knob. 1" diameter. 13/16" high.



Product No.	Mfg. No.	Description	Order Mult.	Weight	Unit Cost
200824-C	BP856-30A	Polished brass with white porcelain (30A) finish	1/0/25	.060	3.29 EA

Amerock Corp.

Furniture Trim Pull - Die-cast 4-15/16" with porcelain insert. 3" center.



Product No.	Mfg. No.	Description	Order Mult.	Weight	Unit Cost
200808-C	BP861-3	Polished brass (3) finish	1/0/25	.130	5.29 EA
206119-C	BP861-BB	Burnished brass (BB) finish	1/0/25	.210	4.79 EA

Amerock Corp.

Furniture Trim Knob - Die-cast with porcelain insert. 1-1/4" diameter. 7/8" high.



Product No.	Mfg. No.	Description	Order Mult.	Weight	Unit Cost
200786-D	BP862-3	Polished brass (3) finish	1/0/25	.090	3.79 EA
207788-C	BP862-BB	Burnished brass (BB) finish	1/0/25	.100	3.29 EA

Amerock Corp.

Furniture Trim Wire Pull - Steel 3-1/4" pull with 3" center.



Product No.	Mfg. No.	Description	Order Mult.	Weight	Unit Cost
207527-C	BP865-26	Polished chrome (26)	1/0/25	.120	3.29 EA
216224-D	BP865-26D	Brushed dull chrome (26D) finish	1/0/25	.120	.79 EA
207535-C	BP865-3	Polished brass (3) finish	1/0/25	.120	3.29 EA
205414-C	BP865-BB	Burnished brass (BB) finish	1/0/25	.120	2.99 EA

Amerock Corp.

Knob - 1-1/4" diameter. 1-1/8" high.



Product No.	Mfg. No.	Description	Order Mult.	Weight	Unit Cost
244740-E	BP1950-B	Solid brass (B) finish	1/0/10	.200	1.79 EA
259845-C	BP1950H-G10	Hollow solid brass, satin chrome finish	1/0/25	.072	3.99 EA
259837-C	BP1950H-BNB	Hollow solid brass, black nickel on solid brass finish	1/0/25	.060	3.99 EA
259829-C	BP1950H-26D	Hollow solid brass, brushed dull chrome on solid brass finish	1/0/25	.072	3.99 EA

KNOBSPULLS

HARDWARE

Amerock Corp.

Knob - 1-1/4" diameter. 15/16" high. Bright brass (B) finish.



Product No.	Mfg. No.	Description	Order Mult.	Weight	Unit Cost
226629-D	BP1956-B	1-1/4" Bb Knob	1/0/10	.120	7.49 EA

National Mfg.

Gallery Series Sash Lock - 600 series. This rigid, traditional, crescent-type lock is for double-hung windows. Steel. Includes screws.



Product No.	Mfg. No.	Description	Order Mult.	Weight	Unit Cost
215939-E	N331520	Oil rubbed bronze, 1 per bag	1/15/75	.071	3.79 BG
215966-E	N325662	Satin nickel, 1 per bag	1/15/60	.024	3.79 BG

Amerock Corp.

Furniture Hinge - Steel. 2" joint, 1-3/8" wide. Tight pin. Antique English (AE) finish.



Product No.	Mfg. No.	Description	Order Mult.	Weight	Unit Cost
208288-C	BP2355-AE	2" Ae Pin Hinge	1/0/25	.118	4.99 PR

Amerock Corp.

Magnetic Touch Latch - Plastic single latch.



Product No.	Mfg. No.	Description	Order Mult.	Weight	Unit Cost
244627-D	BP32301-BR	Brown (cabinet hardware) (BR) finish	1/0/25	.060	3.29 EA
245380-D	BP32301-W	White (W) finish	1/0/25	.060	3.29 EA

Amerock Corp.

Magnetic Catch - Aluminum case, 1-1/2" L. x 13/16" W. x 1/2" H., screws. Aluminum (AL) finish.



Product No.	Mfg. No.	Description	Order Mult.	Weight	Unit Cost
245267-C	BP33772-AL	Alum Magnetic Catch	1/0/25	.160	3.49 EA

Amerock Corp.

Colonial Pull - Weathered steel pull. 5-1/6" with 3-1/4" center.



Product No.	Mfg. No.	Description	Order Mult.	Weight	Unit Cost
219347-D	BP3401-AC	Antique copper (AC) finish	1/0/25	.070	1.29 EA
219793-D	BP3401-CB	Colonial black (CB) finish	1/0/25	.070	1.29 EA

Amerock Corp.

Colonial Knob - Die-cast knob, 1-1/4" diameter.



Product No.	Mfg. No.	Description	Order Mult.	Weight	Unit Cost
219427-E	BP3403-AC	Antique copper (AC) finish	1/0/25	.059	1.29 EA
220184-C	BP3403-CB	Colonial black (CB) finish	1/0/25	.058	.99 EA

Amerock Corp.

Colonial Hinge - Weathered steel H hinge for flush doors. 3-1/2" L. x 1-7/16" W.



Product No.	Mfg. No.	Description	Order Mult.	Weight	Unit Cost
210453-C	BP3404-AC	Antique copper (AC) finish	1/0/25	.155	3.49 PR
210471-C	BP3404-CB	Colonial black (CB) finish	1/0/25	.153	3.49 PR

Amerock Corp.

Hinge - Steel. Overlay, self-closing. 2-3/4" x 1-7/8".



Product No.	Mfg. No.	Description	Order Mult.	Weight	Unit Cost
202983-D	BP3429-3	Polished brass (3)	1/0/25	.260	2.29 PR
238317-D	BP3429-BB	Burnished brass (BB)	1/0/25	.200	2.29 PR

HARDWARE

We can become your single-source supplier on many of the products you currently use!

Amerock Corp.

Roller Catch - Steel. Double roller. Spring cushioned with A strike. 1-5/16" L. x 1-1/16" W. x 5/8" H. Perma bright zinc (2G) finish.



Product No.	Mfg. No.	Description	Order Mult.	Weight	Unit Cost
221977-D	BP3472-2G	Roller Catch	1/0/25	.060	.89 EA

Amerock Corp.

Magnetic Catch - Plastic case. 2" L. x 1-1/8" x 1/2" H. Steel strike 1" L. x 3/4" W. x 1/16" H. Tan plastic (PT) finish.



Product No.	Mfg. No.	Description	Order Mult.	Weight	Unit Cost
208983-D	BP3473-PT	Magnetic Catch	1/0/25	.080	.89 EA

Amerock Corp.

Roller Catch - Steel. Double roller. 1" L. x 15/16" W. x 1/2" H. Steel strike 1" L. x 11/16" W. x 3/8" H. Bright nickel (14) finish.



Product No.	Mfg. No.	Description	Order Mult.	Weight	Unit Cost
221986-D	BP3474-14	Roller Catch	1/0/25	.033	.89 EA

Amerock Corp.

Modern Hinge - Steel. Self-closing hinge. Overlay. Burnished brass (BB) finish.



Product No.	Mfg. No.	Description	Order Mult.	Weight	Unit Cost
202843-C	BP7531-BB	Bb Overlay Hinge	1/0/25	.270	5.29 PR

Amerock Corp.

Functional Self-Closing Hinge - Decorative hinge. 1/2" overlay. Partial wrap.



Product No.	Mfg. No.	Description	Order Mult.	Weight	Unit Cost
202665-C	BP7550-3	Polished brass (3) finish	1/0/25	.240	5.29 PR
202738-C	BP7550-BB	Burnished brass (BB) finish	1/0/25	.240	5.29 PR

Amerock Corp.

Hinge - Steel. Wraparound self-closing hing. 3/8" inset. Burnished brass (BB) finish.



Product No.	Mfg. No.	Description	Order Mult.	Weight	Unit Cost
202657-C	BP7565-BB	3/8" Bb Inset Hinge	1/0/25	.240	5.29 PR

Amerock Corp.

Modern Hinge - Steel. Self-closing hinge. For 3/8" inset. Antique English (AE) finish.



Product No.	Mfg. No.	Description	Order Mult.	Weight	Unit Cost
207624-C	BP7628-AE	3/8" Ae Inset Mod Hinge	1/0/25	.260	4.79 PR

Amerock Corp.

Modern Hinge - Steel. Self-closing hinge. Overlay. Antique English (AE) finish.



Product No.	Mfg. No.	Description	Order Mult.	Weight	Unit Cost
207632-C	BP7629-AE	Ae Overlay Mod Hinge	1/0/25	.250	4.79 PR

HINGES

Amerock Corp.

Self-Closing Hinge - Steel. For 3/8" inset overlapping doors.



Product No.	Mfg. No.	Description	Order Mult.	Weight	Unit Cost
215984-C	BP7928-3	Polished brass (3) finish	1/0/25	.260	4.79 PR
221940-C	BP7928-26	Polished chromium (26) finish	1/0/25	.265	4.79 PR
233367-C	BP7928-AE	Antique English (AE) finish	1/0/25	.265	4.79 PR
213496-C	BP7928-BB	Burnished brass (BB) finish	1/0/25	.260	4.79 PR

Amerock Corp.

Functional Self-Closing Hinge - Decorative hinge. Face mount. Variable overlay.



Product No.	Mfg. No.	Description	Order Mult.	Weight	Unit Cost
213502-C	BP7929-3	Polished brass (3) finish	1/0/25	.238	4.79 PR
231421-C	BP7929-26	Polished chromium (26) finish	1/0/25	.240	4.79 PR
213780-C	BP7929-BB	Burnished brass (BB) finish	1/0/25	.237	4.79 PR

National Mfg.

Magnetic Catches - Sturdy permanent magnet mounted in adjustable modern streamlined nylon case with approximately 14 lb. holding power. Packed 1 per visual pack with screws.



Product No.	Mfg. No.	Description	Order Mult.	Weight	Unit Cost
220905-D	N149823	White Magnetic Catch	1/5/25	.106	2.29 PK

National Mfg.

Magnetic Catch - Reversible. Aluminum case. Magnet has approximately 13 lb. holding power. Packed 1 per visual pack with screws.

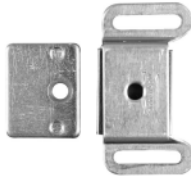

Product No.	Mfg. No.	Description	Order Mult.	Weight	Unit Cost
220914-D	N149898	Alum Magnetic Catch	1/5/25	.119	2.29 PK

HARDWARE

Baldwin Hdwe.

Ball Catch - Solid brass. Polished brass finish. Rolling ball action for perfect tension. Adjustable. Recommended for use on louvered, bifolding, accordion, closet and light to medium service doors when catch is fitted in the door. Strike and proper fasteners included. Face plate: 1" x 2.125". Bore: .875" x 1.25". Strike: 1.375" x 2.125". Lip to center: .875".

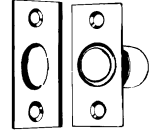

Product No.	Mfg. No.	Description	Order Mult.	Weight	Unit Cost
223174-D	0426-030	Ball Catch	1/0/10	.220	12.79 EA

Baldwin Hdwe.

Roller Catch - Solid brass. Polished brass finish. Heavy-duty, nylon roller. Recommended for use on cabinet, closet and interior doors. Adjustable from 3 lb. to 18 lb. of heading pressure. Strike and proper fasteners included. Face plate: 1" x 2.25". Bore: 1" x 1.625". Strike: 1.125" x 2.75". Lip to center: 1.312".

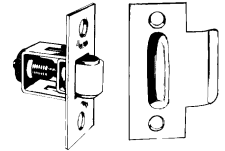

Product No.	Mfg. No.	Description	Order Mult.	Weight	Unit Cost
223182-D	0440-030	Roller Catch	1/0/10	.220	16.79 EA

Amerock Corp.

Magnetic Catch - Plastic case.



1-15/16" L. x 11/16" W. Strike: 1-1/8" L. x 7/8" W. x 3/4" H. Tan plastic (PT) finish.

Product No.	Mfg. No.	Description	Order Mult.	Weight	Unit Cost
216233-C	BP9765-3PT	Magnet Catch	1/0/25	.067	2.49 EA

Amerock Corp.

Magnetic Catch - Aluminum case dual action. 2" L. x 1" W. x 5/8" H. Strike: 1-1/8" L. x 3/4" W. Aluminum (AL) finish.



Product No.	Mfg. No.	Description	Order Mult.	Weight	Unit Cost
223779-B	BP9783-AL	Magnet Catch	1/0/25	.085	1.99 EA

Amerock Corp.

Magnetic Catch - Heavy-duty. Woodgrain aluminum (AW) case. 2-1/32" L. x 1-1/16" W. x 13/16" H. Strike: 1" L. x 3/4" W.



Product No.	Mfg. No.	Description	Order Mult.	Weight	Unit Cost
206379-C	BP9798-AW	Magnet Catch	1/0/25	.475	3.79 EA

HARDWARE

Amerock Corp.

Roller Catch - Steel. Spring cushioned roller with A and B strikes. 1-3/4" L. x 1-1/4" W. x 3/8" H. Perma brite zinc (2G) finish.



Product No.	Mfg. No.	Description	Order Mult.	Weight	Unit Cost
208894-C	BP9823-2G	Roller Catch	1/0/25	.053	1.99 EA

Amerock Corp.

Concealed Hinge - Frameless hinge, full overlay, 110° opening, nickel finish. Due to the highly technical nature of these concealed hinges, further information regarding concealed hinges may be obtained from the manufacturer. Pair.



Product No.	Mfg. No.	Description	Order Mult.	Weight	Unit Cost
244821-C	BP4611-A14	Concealed Hinge	1/0/10	.400	10.99 PR

Amerock Corp.

Pull - Hardwood pull. 3" center. 3-1/2" L. x 1/2" W. x 1-1/8" projection.



Product No.	Mfg. No.	Description	Order Mult.	Weight	Unit Cost
217212-C	937	3-1/2" Wood Pull	1/0/25	.044	2.49 EA

Waddell

Hardwood Dowel Pin - For craft and construction projects. Packaged 25 poly bags per box.



Product No.	Mfg. No.	Description	Order Mult.	Weight	Unit Cost
203998-E	774DI	1/4" x 1-1/4", packed 25 in poly bag	1/0/25	.040	1.79 BG
204005-E	775DI	5/16" x 1-1/2", packed 20 in poly bag	1/0/25	.060	1.79 BG
204021-E	776DI	3/8" x 2", packed 15 in poly bag	1/0/25	.080	1.79 BG
204048-E	778DI	1/2" x 2", packed 10 in poly bag	1/0/25	.100	1.79 BG

Waddell

Hardwood Shaker Peg - For craft and construction projects. Packaged 2 shaker peg per poly bag, and 25 poly bags per box. Shaker peg is 3-3/8" L. x 7/8" diameter with 1/2" tenon.



Product No.	Mfg. No.	Description	Order Mult.	Weight	Unit Cost
208663-E	760DI	3-3/8x7/8 Shaker Peg	1/0/25	.060	1.79 BG

Waddell

Oak Shaker Peg - For craft and construction projects. Packaged 2 shaker pegs per poly bag, and 25 poly bags per box. Shaker peg is 3-3/8" L x 7/8" diameter with 1/2" tenon.



Product No.	Mfg. No.	Description	Order Mult.	Weight	Unit Cost
214787-E	760DIO	3-3/8x7/8 Oak Shaker Peg	1/0/25	.060	1.79 BG

Knape & Vogt

Extension Drawer Slides - 3-1/8" high with side-mounted styling. Ball bearing nylon rollers provide smooth operation, positive stop. Drawer may be removed by depressing stop lever. Requires 1/2" clearance each side. Rust-resistant, precoated cold rolled steel. Rated for 60 lb. load with 20" normal use. Includes screws and instructions. Packaged 2 per set.

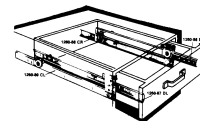

Product No.	Mfg. No.	Description	Order Mult.	Weight	Unit Cost
222137-C	1260P-18	Approximately 18"	1/0/10	2.000	7.49 SET
222146-C	1260P-20	Approximately 20"	1/0/10	2.119	7.79 SET
222155-C	1260P-22	Approximately 22"	1/0/10	2.300	7.99 SET
222164-C	1260P-24	Approximately 24"	1/0/10	2.525	8.49 SET

Knape & Vogt

Extension Drawer Slide - Single track under drawer slide. Flanged nylon roller prevents side binding. Rated at 50 lb. load capacity with 20" size. Minimum side clearance of 1/16" (0.16cm) and minimum height of 1" (2.54cm). Mounts with staples or screws. Assembly includes model No. 1175-6 plastic mounting bracket, model No. 1175-63 steel mounting bracket, model No. 1175-64 track, model No. 1175-82 rear roller, and model No. 1175-84/85 right and left hand front roller. Screws included. Zinc-plated. Packaged 1 set per poly bag. Can be cut to exact size needed.



Product No.	Mfg. No.	Description	Order Mult.	Weight	Unit Cost
226507-B	1175PZC	Approximately 18"	1/0/10	.617	4.29 SET
217456-C	1175PZC	Approximately 22-5/8"	1/0/10	.525	4.49 SET
243000-C	1175PZC	Approximately 24"	1/0/10	.774	4.79 SET

Knape & Vogt

Extension Drawer Slides - 3" high. Side mount styling. Ball bearing nylon rollers. Positive stop lever prevents accidental drawer removal. (Drawer may be removed by depressing stop lever.) Zinc-plated cold rolled steel. Rated for 75 lb. load with 20" in normal usages. Mounts with pan head screws, included. Packaged 2 per set.

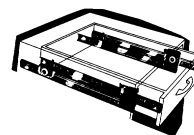

Product No.	Mfg. No.	Description	Order Mult.	Weight	Unit Cost
242993-C	1300PZC-16	Approximately 16"	1/0/10	1.600	8.79 SET
209244-C	1300PZC-18	Approximately 18"	1/0/10	1.807	8.79 SET
209252-C	1300PZC-20	Approximately 20"	1/0/10	1.945	9.29 SET
209260-C	1300PZC-22	Approximately 22"	1/0/10	2.132	9.49 SET

Knape & Vogt

Drawer Slide - 1-9/32" high. Bottom or side mounting style. Solid stud acetal roller, captive in 1 channel member. Positive stop, lift-out disconnect, *stay closed design*. Almond, white epoxy-coated cold rolled steel. Rated for 100 lb. load with 20" in normal usages. Includes screws and instructions. Packaged 2 per set.



Product No.	Mfg. No.	Description	Order Mult.	Weight	Unit Cost
254525-D	1284P WH 400	Approximately 16" white	1/0/10	1.490	7.79 SET
254533-D	1284P WH 450	Approximately 18" white	1/0/10	1.600	8.29 SET
254541-D	1284P WH 500	Approximately 20" white	1/0/10	1.690	8.79 SET
254568-D	1284P WH 550	Approximately 22" white	1/0/10	1.760	8.99 SET
254517-D	1284P ALM 400	Approximately 16" almond	1/0/10	1.490	7.99 SET
232114-D	1284P ALM 450	Approximately 18" almond	1/0/10	1.598	8.29 SET
232122-D	1284P ALM 500	Approximately 20" almond	1/0/10	1.687	8.79 SET
232130-D	1284P ALM 550	Approximately 22" almond	1/0/10	1.763	8.99 SET

DRAWER SLIDES

Knape & Vogt

Self-Close Euro Drawer Slide - For use in kitchen cabinets, commercial millwork, home office, and RTA furniture applications.

Adaptable to face frame or 32mm mounting. Euro screw hole pattern for traditional of



European-style cabinet construction. Self-aligning roller. Positive in-stop, positive double out-stop; 4-way adjustment slots; positive lock-open position; self-closing. Screws not included. Cream (CW) epoxy-coated finish. Rated for 75 lb. Packaged 2 per set.

Product No.	Mfg. No.	Description	Order Mult.	Weight	Unit Cost
254495-D	1805H CW 400	Approximately 16"	1/0/20	1.180	5.99 SET
250503-D	1805H CW 450	Approximately 18"	1/0/20	1.350	6.29 SET
250481-D	1805H CW 500	Approximately 20"	1/0/20	1.520	6.79 SET
250473-D	1805H CW 550	Approximately 22"	1/0/20	1.680	6.99 SET

Knape & Vogt

Vertical File Drawer Slide - Heavy-duty, telescopic full extension slide. For box drawer or pedestal file drawers up to 18" wide. Progressive movement on precision steel ball bearings. Lever disconnect for easy drawer removal. Requires 1/2" clearance each side.



Zinc-plated cold rolled steel. Rated for 100 lb. load. Packaged 2 per set.

Product No.	Mfg. No.	Description	Order Mult.	Weight	Unit Cost
254509-B	8400P-16	Approximately 16"	1/0/10	2.760	15.49 SET
202452-C	8400P-18	Approximately 18"	1/0/10	3.105	18.99 SET
202460-C	8400P-20	Approximately 20"	1/0/10	3.452	19.79 SET
202479-C	8400P-22	Approximately 22"	1/0/10	3.800	21.49 SET

Faultless Caster

Lazy Susan - 1-unit construction. No separate parts, preassembled so there is no contact under load except through the rolling balls. Center opening allows for center post and ease of centering the unit. Attaches easily to second surface even though hidden after it is fastened to first surface. Only 5/16" thick adds a minimum of height to item. (Can be recessed into surfaces, reducing space to 1/8".) Triangle's large ball race designed for maximum stability. Bearing is interlocked. No rivet to work loose or bind.

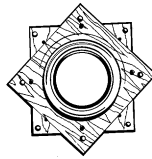

Product No.	Mfg. No.	Description	Order Mult.	Weight	Unit Cost
212458-D	27646	3", 100 lb. weight rating	1/0/10	.211	2.29 EA
212466-D	27647	4", 200 lb. weight rating	1/0/10	.321	2.79 EA
212474-D	27648	6", 500 lb. weight rating	1/0/10	.573	3.79 EA
212482-D	27649	12", 1000 lb. weight rating	1/0/10	.849	8.29 EA

United States Hdwe.

4" x 8" Deluxe Register - For floor to distribute heat. Mar-resistant baked enamel finish with damper. Manufactured from steel. Color is brown enamel. 1 register per bag.



Product No.	Mfg. No.	Description	Order Mult.	Weight	Unit Cost
220965-D	V-056IB	Brown enamel	1/10/20	1.277	8.99 EA
250996-D	V-056IWB	White enamel	1/10/20	2.434	8.99 EA

HARDWARE

United States Hdwe.

4" x 10" Deluxe Register - For floor to distribute heat.

Mar-resistant baked enamel finish with damper. Manufactured from steel. Color is brown enamel. 1 register per bag.

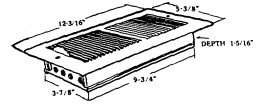

Product No.	Mfg. No.	Description	Order Mult.	Weight	Unit Cost
220973-D	V-057IB	Brown enamel	1/10/20	1.472	8.99 EA
251038-D	V-057IWB	White enamel	1/10/20	1.470	9.29 EA

United States Hdwe.

4" x 8" Register - For floor to distribute heat. Mar-resistant baked enamel finish with damper. Manufactured from steel. Color is brown enamel. 1 register per bag.

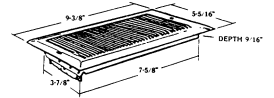

Product No.	Mfg. No.	Description	Order Mult.	Weight	Unit Cost
220981-D	V-102B	Brown enamel	1/12/24	.971	8.99 EA
251046-D	V-102WB	White enamel	1/12/24	1.942	8.99 EA

United States Hdwe.

4" x 10" Register - For floor to distribute heat. Mar-resistant baked enamel finish with damper. Manufactured from steel. Color is brown enamel. 1 register per bag.

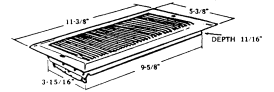

Product No.	Mfg. No.	Description	Order Mult.	Weight	Unit Cost
221007-D	V-103B	Brown enamel	1/12/24	1.162	8.99 EA
251054-D	V-103WB	White enamel	1/12/24	1.162	9.29 EA

Solar Group

Deluxe No. T1 Rural Mailbox - Reinforced rib design with embossed side and door panels for name and number. Manufactured from hot-dipped galvanized steel. Finished with a baked-on polyester enamel and clear polyester coating. Individually packaged in appealing carton. Exceeds U.S. Post Office specifications. Dimensions: 19" L. x 6-3/4" W. x 8-3/4" H. Gray.



Product No.	Mfg. No.	Description	Order Mult.	Weight	Unit Cost
205780-C	ST10	Gray T1 Mailbox	0/0/1	5.000	8.79 EA

Steel City Corp

Rural Mailbox - Black. Standard size (#1). Made of ribbed galvanized steel. Individually boxed. Meets all U.S. Post Office specifications. Embossed smooth area for name or number on door. Dimensions: 18-3/4" L. x 8-3/4" H. x 6-1/4" W.



Product No.	Mfg. No.	Description	Order Mult.	Weight	Unit Cost
206431-B	1-C	Blk Steel T1 Mailbox	1/0/70	5.000	9.49 EA

Steel City Corp

Drive N Mount Mounting Post - 2-1/2" square 16-gauge steel tubing post with adjustable 1-1/2" square steel tubing arm. Mounting bracket can be adjusted to fit all U.S. rural mailboxes. Bottom of post pointed for easy driving into ground. Black finish. Post assembles to 5' (2-pieces).



Product No.	Mfg. No.	Description	Order Mult.	Weight	Unit Cost
239307-C	DM-1	Drive-in-mounting Post	0/0/1	17.000	35.49 EA

Solar Group

Deluxe No. T1 Rural Mailbox - Reinforced rib design with embossed side and door panels for name and number. Manufactured from solid aluminum. Individually packaged in eye appealing full-color carton. Exceeds U.S. Post Office specifications. Dimensions: 19" L. x 6-3/4" W. x 8-3/4" H.

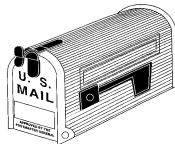

Product No.	Mfg. No.	Description	Order Mult.	Weight	Unit Cost
205833-D	ALM11000	Aluminum T1 Mailbox	0/0/1	2.420	21.49 EA

Solar Group

Deluxe No. T3 Rural Mailbox - Reinforced rib design with embossed side and door panels for name and number. Manufactured from hot-dipped galvanized steel. Finished with a baked-on polyester enamel and clear polyester coating. Individually packaged in eye appealing full-color carton. Exceeds U.S. Post Office specifications. Dimensions: 15" H. x 11-1/2" W. x 23-1/2" D.



Product No.	Mfg. No.	Description	Order Mult.	Weight	Unit Cost
206440-D	ST20	Gray	0/0/1	13.000	39.99 EA
235597-D	ST20B	Black	0/0/1	18.000	39.99 EA

Flambeau Prod.

No. 1 Poly Mailbox - Molded in 1-piece from top grade copolymer materials with interior strut construction. Fully assembled. Individually packaged in self-selling cartons. Approved by the Postmaster General. Dimensions: 19" L. x 6-3/4" W. x 9-7/8" H.



Product No.	Mfg. No.	Description	Order Mult.	Weight	Unit Cost
221937-D	T-R4501BL	Black	0/0/1	4.500	10.79 EA
226122-D	T-R4503WT	White	0/0/1	4.500	10.79 EA
259306-D	TR4505GR	Green	0/0/1	3.000	10.79 EA

Solar Group

Curbside Mailsafe - Lockable mailbox. Full service for incoming and outgoing mail. Extra wide mail slot meets and exceeds Postal Regulations. Slide-out mail signal, alerts mail carrier of outgoing mail. Concealed locking access door for easy mail retrieval. Outgoing mail clip for easy access to outgoing mail. Black. Made of plastic and metal. 9-1/2" H. x 13" W. x 23-1/2" D.



Product No.	Mfg. No.	Description	Order Mult.	Weight	Unit Cost
204285-B	RSKB000	Lockable Rural Mailbox	0/0/1	15.000	89.99 EA

Step 2

Mailmaster® Triline™ Plus Mailbox - All-in-1 mailbox, newspaper compartment, and post. Weather-resistant heavy-duty poly construction. Rear door access to avoid street and moving vehicles. Sturdy double-wall design is vandal-resistant. Mounts on existing or new 4x4 post (not included). Fully assembled. Dimensions: 23.5" L. x 9.25" W. x 50.25" H. 15.5 lb.



Product No.	Mfg. No.	Description	Order Mult.	Weight	Unit Cost
242810-A	5330	Spruce green	0/0/1	15.500	54.99 EA
201308-A	5320	Stone gray (taupe)	0/0/1	15.500	54.99 EA
250570-A	5340	Black	0/0/1	15.500	54.99 EA

Solar Group

Standard Cedar Post - Traditional double-notch joint. Extra tall, longer crossarm accommodates larger mailboxes and post planter. Mailbox post components are securely attached with staples. Assembly instructions and hardware included. Post measures 74" with 19-1/2" shelf for mailbox.



Product No.	Mfg. No.	Description	Order Mult.	Weight	Unit Cost
217441-D	CC-5R	Standard Cedar Post	1/4/24	30.000	43.99 EA

Fulton

Mailbox - Security hasp, black satin finish. Magazine rack included. 5-1/2" W. x 10-1/2" H. x 2" D. Made of quality steel.



Product No.	Mfg. No.	Description	Order Mult.	Weight	Unit Cost
238326-D	15W	Black Vertical Mailbox	1/0/10	1.300	10.99 EA

AF 1250 SERIES VERTICAL MAILBOXES

Auth-Florence 1250 Series Vertical Mailboxes are USPS 4B+ APPROVED and designed for use in small, multi-family apartment buildings. They are constructed of durable, heavy-gauge extruded aluminum. Doors and trim are striated to resist scratching. Mailboxes feature a full mounting frame that ensures complete enclosure of mail compartments. 1250 Series mailboxes are available in configurations from three to seven compartments.



Model 1250-5HA w/ Clear Anodize and Recess Mount shown above

Features:

- Door Dim. - 5 1/2" W x 15" H
- Locks - 5-Pin Cylinder Locks w/ two (2) Keys

Specify:

1. Installation -
 - Recessed (6 3/4" Wall Depth)
 - Surface Applied - Requires - SM-125 Collar
2. Finish -
 - Clear Anodize
 - Gold Anodize

Important Notice:
Mailboxes designed to USPS 4B+ Standards may only be used for replacement of existing mailboxes after October 5, 2006. For NEW construction mailbox needs, see the new Auth-Florence 4C Horizontal mailbox systems.

PRICING:			
1250 Series Verticals - Specify Clear or Gold Finish		1250 Series SM125 Collars - For Surface Mount Applications	
1250-3HA	\$95.51 ea.	SM125-3	19.24 ea.
1250-4HA	\$124.90 ea.	SM125-4	25.19 ea.
1250-5HA	\$143.27 ea.	SM125-5	31.49 ea.
1250-6HA	\$156.91 ea.	SM125-6	36.74 ea.
1250-7HA	\$179.65 ea.	SM125-7	44.08 ea.

HARDWARE

AF 1400 SERIES HORIZONTAL MAILBOX



Model 1400-75 Front Load w/ Clear Anodize and 34 usable compartments

Auth-Florence 1400 and 1500 Series Horizontal Mailboxes are USPS 4B+ Approved and designed for use in larger multi-family apartment buildings, dormitories, office high-rises, etc. They are constructed of heavy-gauge aluminum. Front-loading boxes require one compartment to be a master door for Postal Service use. Rear-loading boxes require a rear cover. All horizontal mailboxes are recess-mounted.

Features:

- ❑ Door Dim.- 6" W x 5" H
- ❑ Locks - 5-Pin Cylinder Locks w/ two (2) Keys
- ❑ Clear plastic window number slots
- ❑ 15½" deep compartments

Specify:

1. Installation -
 - ❑ Recess Mounted
 - ❑ Rear Cover Included on Rear-Loading boxes
 - ❑ Snap-On Trim (*Optional Add \$1.00 per compartment)
 - ❑ Front-Load Cabinets lose one compartment to USPS Master Door
2. Finish -
 - ❑ Clear Anodize
 - ❑ Powder Coat Metallic Gold
 - ❑ Powder Coat Bronze

Important Notice: Mailboxes designed to USPS 4B+ Standards may only be used for replacement of existing mailboxes after October 5, 2006. For NEW construction mailbox needs, see Auth-Florence 4C Horizontal mailbox systems.

PRICING (per Cabinet/front loading models):		
1400-53HSA (5 high/3 wide = 14 tenant doors)	\$398.72	<i>NOTE: Custom configured mailboxes available. Powder coat finishes also available – add 15%. Call for options.</i>
1400-54HSA (5 high/4 wide = 19 tenant doors)	\$525.49	
1400-55HSA (5 high/5 wide = 24 tenant doors)	\$652.26	
1400-63HSA (6 high/3 wide = 17 tenant doors)	\$474.78	
1400-64HSA (6 high/4 wide = 23 tenant doors)	\$626.91	
1400-73HSA (7 high/3 wide = 20 tenant doors)	\$550.85	
1400-74HSA (7 high/4 wide = 27 tenant doors)	\$709.92	
1400-75HSA (7 high/5 wide = 24 tenant doors)	\$905.80	
*Trim per door	\$ 1.00	

Auth-Florence 4C Horizontal Mailbox Systems



Auth-Florence new 4C Horizontal Mailbox Systems are designed to meet or exceed new USPS 4C standards for security and performance. Auth-Florence 4C models are available in Suites that provide the ability to easily mix-and-match various modules to easily and efficiently complete an attractive yet exceptionally secure wall-mounted mailbox system.

USPS STD-4C mailboxes are required on any NEW construction on or after October 5, 2006.

Features:

- Rugged, corrosion resistant weatherproof powdercoat finish resists scratching and vandalism.
- For indoor and outdoor applications.
- Constructed of heavy gauge aluminum and 300 series stainless steel components for superior strength, corrosion resistance and exceptional durability
- Unique double-locking parcel mechanism design (patent pending) for added mail package security
- New USPS-1172 910A lock with three (3) keys
- Exclusive Auth-Florence multi-unit connector kit hardware (patent pending) included with every mailbox module for convenience and ease of installation

Specify:

1. Powdercoat Paint Finish

- Blonde Gold*
- Silver Speck
- Black
- White
- Sandstone
- Bright Gold*
- Postal Grey
- Dark Bronze
- Forest Green

2. Identification

- Number Decals
- Engraved

*Note: All powdercoat paint colors (except Blonde & Bright Gold) are weather resistant and may be used for indoor or outdoor installations.

Pricing: (double column=30 5/16" wide, single column=17 1/2" wide)

4CAT8-19	(39" high/double column/19 tenant doors)	\$1,099.56
4CAT2-15	(39" high/double column/15 tenant/1-15" parcel door)	\$1,149.54
4CAT1-4	(39" high/single column/4 tenant/1-15" parcel door)	\$ 584.77
4CAT6-9	(39" high/single column/9 tenant doors)	\$ 609.76
4CAT10	(39" high/single column/1-15" & 1-18" parcel door)	\$ 549.78
4CBT8-7	(18" high/double column/7 tenant doors)	\$ 724.71
4CBT8-3	(18" high/double column/3 tenant/1-18" parcel door)	\$ 699.72
4CBT6-3	(18" high/single column/3 tenant doors)	\$ 449.82
4CBT10	(18" high/single column/1-18" parcel door)	\$ 349.86
4CCT2-16	(51 1/4" high/double column/16 tenant doors)	\$1,374.45
4CCT1-7	(51 1/4" high/single column/7 tenant/1-18" parcel door)	\$ 774.69
4CCT10	(51 1/4" high/single column/1-15" & 1-18" parcel door)	\$ 724.71

(More 4C models available – call for options and pricing)

AUTH-FLORENCE CLUSTER BOX UNITS



Model 1570 Type I

Model 1570 Type II

Model 1570 Type III

Model 1570 Type IV

Auth-Florence 1570 "F" Series CBUs are USPS APPROVED. These Cluster Boxes offer superior durability and a high level of security in an easy-to-use, attractive freestanding unit. They are designed for use throughout the U.S. in all weather conditions. Available in four sizes, each CBU has a parcel locker equipped with a USPS 910A lock and an outgoing-mail slot. Mail carriers can gain easy access to all mail slots through master door gates hinged on the outer corners of the cluster box. The Auth-Florence 1570 design was selected by the USPS as the standard for all new "F-specification" cluster boxes.

Features:

- ✓.100" thick welded aluminum protective outer cabinet
- ✓.125"-.250" thick aluminum doors
- ✓Tough, scratch- and corrosion-resistant powder coat finish
- ✓Stainless steel hardware and hinges
- ✓5-pin cam locks, with spring loaded cover
- ✓Quick-release door-lock latch
- ✓Number decals standard (engraving optional)

<u>PRICING:</u>	<u>ALL UNITS TO OVERALL SIZE</u> 28 ½"W x 62"H x 17 ½"D	
1570-8AF	Type I (8 tenant doors, 2 parcel lockers)	\$1,173.97
1570-12AF	Type II (12 tenant doors, 1 parcel locker)	\$1,166.55
1570-16AF	Type III (16 tenant doors, 2 parcel lockers)	\$1,245.03
1570-13AF	Type IV (13 business boxes, 1 parcel locker)	\$1,210.03

AUTH-FLORENCE POSTAL ACCESSORIES



Model 690



Model 689



Model 686

Auth Chimes, a division of Auth-Florence, offers a wide selection of low-cost chimes for residential, commercial and municipal applications. Auth is the only chime manufacturer to offer fire-rated viewers on some of its chime models.

Model 690	\$21.16 ea.
Model 689	\$27.56 ea.
Model 686	\$20.88 ea.



Model KK

Key Keepers allow the front door of a building to be locked, and the key to the door stored safely in the key keeper. The key keeper is locked with a postal or private master lock.

Model KK \$22.74 ea.



Model LD12

Letter Drop with spring-hinged front door for door or wall installation, extruded aluminum construction, rough opening 5"H x 12-5/8"W, frame size 6-5/16" H x 14-1/16"W x 3/4"D, Door size 4"H x 11-3/4"W, engraved "U.S. Mail" standard and anodized aluminum finish.

Model LD12 \$76.18 ea.



Model D300

D300 directories are surface mounted and can be used independently or with mailboxes. They include a clear plastic window, metal back plate, and blank ruled name cards.

19 1/8" H x 13 5/8" W
Model D300-2 \$53.44 ea.

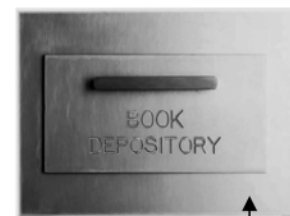

Model CC11RL

CC11RL Book Depository made from 1/4" thick extruded aluminum construction. Rough opening 11-1/4"H x 16-1/2" W Frame size 14"H x 19"W Hopper door size 8"H x 15"W Anodized aluminum finish. Engraved "Book Depository"

CC11RL \$356.27 ea.



Model 130

Model 130 Vertical Collection Boxes for installations serviced by the USPS and those with private mail collection.

Surface Mount
23 5/8" H x 15 3/16" W
Model 130SMS \$163.73 ea.

AF MB2000 Private Locking Mailbox

Secure your incoming mail **and parcels** with the state-of-the-art MB2000 from Auth-Florence Manufacturing. The MB2000 Lockable Mailbox was designed for the individual or SOHO user desiring a mailbox with increased security, expanded storage capabilities and durable construction. The MB2000 provides the following standard features:

- ☞ Multiple Installation Options – Curbside / Post / Wall
- ☞ *All Aluminum* Construction assures **RUST-FREE** Performance
- ☞ Outgoing Mail Slot
- ☞ Meets USPS Standard 7
- ☞ Accepts Envelopes up to 10”x1.75”x12”
- ☞ Provides easy and secure access for owner via:
 - Large Storage Capacity
 - Standard 5-Pin Cylinder Lock
- ☞ Optional Read-Fit Aluminum Post (MB2001) for Curbside Mounting

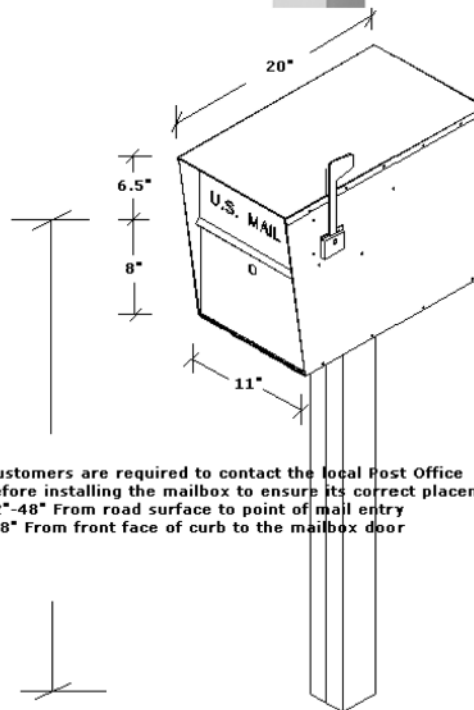

Customers are required to contact the local Post Office before installing the mailbox to ensure its correct placement.
 42"-48" From road surface to point of mail entry
 6-8" From front face of curb to the mailbox door

<u>PRICING:</u>	
MB2000	- \$158.95
MB2001	- \$ 65.77

MAILBOX

Fulton

Mailbox - Satin finish. Box made of textured metal. Self-locking hinge. Preassembled matching magazine rack included.



Product No.	Mfg. No.	Description	Order Mult.	Weight	Unit Cost
238353-D	3235	Black, 15" W. x 6-1/4" H. x 3" D.	1/0/5	3.200	17.99 EA
202770-D	3275	White, 15" W. x 6-1/4" H. x 3" D.	1/0/5	3.200	17.99 EA

Fulton

Mailbox - Painted textured steel. Preassembled matching magazine rack included.



Product No.	Mfg. No.	Description	Order Mult.	Weight	Unit Cost
238362-D	3277	Black, 8-1/2" W. x 10" H. x 3" D.	1/0/5	3.000	17.99 EA

Fulton

Lockable Mailbox - Black satin finish. Brass plated medallion. Key locking security lock. Preassembled matching magazine rack included. 15" W. x 6-1/4" H. x 3" D.



Product No.	Mfg. No.	Description	Order Mult.	Weight	Unit Cost
202789-D	3495-L	Locking Mailbox	1/0/5	3.600	16.99 EA

Solar Group

Lockable Security Mailbox - Extra large Mailsafe™ mailbox. Heavy-duty construction. Durable aluminum mail slot for incoming and outgoing mail. Easy-Up™ flag assembles in minutes. Heavy-duty access door protects mail. 2 camlock keys. Can be mounted at house or curb. Includes bracket for post mounting at the curb. Rustproof. Color: Black. Dimensions: 12-1/2" H. x 15-1/4" W. x 7-13/16" D.



Product No.	Mfg. No.	Description	Order Mult.	Weight	Unit Cost
212253-B	MSK	Black Security Mailbox	1/0/2	12.500	92.99 EA

HARDWARE

Solar Group

Heavy-Duty Round Mailbox Post - With decorative scroll. Fits all rural-style mailboxes. Flattened sides at the bottom prevents turning. Includes all mounting hardware. Baked-on black enamel on galvanized steel. Individually cartoned.



Product No.	Mfg. No.	Description	Order Mult.	Weight	Unit Cost
205931-D	PBK	Round Post W/scroll	0/0/1	5.000	19.49 EA

Hy-Ko Prod.

Reflective Letters And Numbers - 1-1/4" figure on a 2" reflecting panel. Long-lasting, weather-resistant self-adhesive. Black characters on white reflective background.



Product No.	Mfg. No.	Description	Order Mult.	Weight	Unit Cost
215716-F	RV15-A	1" Reflect Letter A	0/0/10	.001	.49 EA
215708-F	RV15-B	1" Reflect Letter B	0/0/10	.001	.49 EA
215694-F	RV15-C	1" Reflect Letter C	0/0/10	.001	.49 EA
215686-F	RV15-D	1" Reflect Letter D	0/0/10	.001	.49 EA
215678-F	RV15-E	1" Reflect Letter E	0/0/10	.001	.49 EA
215651-F	RV15-F	1" Reflect Letter F	0/0/10	.001	.49 EA
215643-F	RV15-G	1" Reflect Letter G	0/0/10	.001	.49 EA
215627-F	RV15-H	1" Reflect Letter H	0/0/10	.001	.49 EA
215619-F	RV15-I	1" Reflect Letter I	0/0/10	.001	.49 EA
215600-F	RV15-J	1" Reflect Letter J	0/0/10	.001	.49 EA
215597-F	RV15-K	1" Reflect Letter K	0/0/10	.001	.49 EA
215589-F	RV15-L	1" Reflect Letter L	0/0/10	.001	.49 EA
215570-F	RV15-M	1" Reflect Letter M	0/0/10	.001	.49 EA
215562-F	RV15-N	1" Reflect Letter N	0/0/10	.001	.49 EA
215538-F	RV15-P	1" Reflect Letter P	0/0/10	.001	.49 EA
215511-F	RV15-Q	1" Reflect Letter Q	0/0/10	.001	.49 EA
215503-F	RV15-R	1" Reflect Letter R	0/0/10	.001	.49 EA
215481-F	RV15-S	1" Reflect Letter S	0/0/10	.001	.49 EA
215473-F	RV15-T	1" Reflect Letter T	0/0/10	.001	.49 EA
215465-F	RV15-U	1" Reflect Letter U	0/0/10	.001	.49 EA
215457-F	RV15-V	1" Reflect Letter V	0/0/10	.001	.49 EA
215422-F	RV15-W	1" Reflect Letter W	0/0/10	.001	.49 EA
215414-F	RV15-X	1" Reflect Letter X	0/0/10	.001	.49 EA
215406-F	RV15-Y	1" Reflect Letter Y	0/0/10	.001	.49 EA
215333-F	RV15-Z	1" Reflect Letter Z	0/0/10	.001	.49 EA
215848-F	RV15-0	1" Reflect Number 0	0/0/10	.001	.49 EA
215821-F	RV15-1	1" Reflect Number 1	0/0/10	.001	.49 EA
215805-F	RV15-2	1" Reflect Number 2	0/0/10	.001	.49 EA
215791-F	RV15-3	1" Reflect Number 3	0/0/10	.001	.49 EA
215783-F	RV15-4	1" Reflect Number 4	0/0/10	.001	.49 EA
215775-F	RV15-5	1" Reflect Number 5	0/0/10	.001	.49 EA
215767-F	RV15-6	1" Reflect Number 6	0/0/10	.001	.49 EA
215759-F	RV15-7	1" Reflect Number 7	0/0/10	.001	.49 EA
215740-F	RV15-8	1" Reflect Number 8	0/0/10	.001	.49 EA
215732-F	RV15-9	1" Reflect Number 9	0/0/10	.001	.49 EA
215392-F	RV15-AMPER-SAND	1" Reflect Ampersand	0/0/10	.001	.49 EA
215384-F	RV15-HYPHEN	1" Reflect Hyphen	0/0/10	.001	.49 EA
215376-F	RV15-PERIOD	1" Reflect Period	0/0/10	.001	.49 EA
215368-F	RV15-BLANK	1" Reflect Blank	0/0/10	.001	.49 EA

HARDWARE



Commercial & Industrial Sign Center

15" x 19" Heavy-Duty Plastic Parking Signs

■ Commercial-grade plastic ■ Individually packaged

SIZE: 15" x 19" PACK: 1 EACH WEIGHT: .13 LBS. COLOR: MULTIPLE



700 245933



701 245917



702 245925

Heavy-Duty Aluminum Highway Signs

■ Individually packaged in polybags ■ Pre-punched mounting holes



HW-1 224685



HW-4 224693



HW-6



HW-7 224707



HW-9



HW-10 224715



HW-11



HW-13 224723



HW-21



HW-23 224731



HW-24



HW-26



HW-27



HW-29



HW-30



HW-32 246107



HW-34



HW-35 (BLANK)



HW-37



HW-38



HW-39



HW-42



HW-43



HW-44



HW-45



HW-47



HW-49



HW-22
SIZE: 12" X 12"
WEIGHT: .40 LBS.

SIZE: 12" X 18" RECTANGLE EXCEPT WHERE NOTED

PACK: 1 EACH

WEIGHT: .85 LBS. EXCEPT WHERE NOTED

COLOR: MULTIPLE

5" Reflective Hi-Visibility House Numbers



Hy-Ko Part No.	Description
920	5" Reflective House No. 0
921	5" Reflective House No. 1
922	5" Reflective House No. 2
923	5" Reflective House No. 3
924	5" Reflective House No. 4
925	5" Reflective House No. 5
926	5" Reflective House No. 6
927	5" Reflective House No. 7
928	5" Reflective House No. 8
929	5" Reflective House No. 9

SIZE: 5 1/4" WHITE NUMBER ON 6" GREEN PLATE CARD SIZE: 3 7/8" X 7 1/2"
 PACK: 5 EACH WEIGHT: .15 LBS.



6" x 18" Reflective Address Plate

SIZE: 6" X 18" (PLATE)
 PACK: 5 EACH
 WEIGHT: .70 LBS.
 COLOR: GREEN REFLECTIVE PLATE WITH SILVER REFLECTIVE NUMBERS

911 252166

10" x 14" Heavy-Duty Polyethylene OSHA Signs

■ Durable ■ Weather-resistant ■ Use in industrial workplace settings ■ Choose between these wordings: "DANGER", "WARNING", "CAUTION", "SAFETY FIRST" and "NOTICE"

 501 244473	 507 244481	 508 244503	 509	 512 245852	 514	 515 245860
 517	 520 244511	 523 244538	 525	 528	 529	 530
 540 245879	 541	 542	 543	 550	 554	 557 245887
 559	 562 244546	 570 245895	 571	 572	 573	 580 245909

SIZE: 10" x 14" PACK: 5 EACH WEIGHT: 1.32 LBS. COLOR: DANGER (RED & BLACK); CAUTION (YELLOW & BLACK); NOTICE (BLUE & WHITE); SAFETY (GREEN & WHITE); WARNING (ORANGE & BLACK)

Heavy-Duty Aluminum Highway Signs



HW-31 224758
 SIZE: 18" X 18" OCTAGON
 PACK: 1 EACH
 WEIGHT: 1.1 LBS.
 COLOR: RED & WHITE



HW-65
 SIZE: 24" X 24" OCTAGON
 PACK: 1 EACH
 WEIGHT: 2.82 LBS.
 COLOR: RED & WHITE



HW-62
 SIZE: 16" X 16" DIAMOND
 PACK: 1 EACH
 WEIGHT: 1.01 LBS.
 COLOR: YELLOW & BLACK

Poly Safety Tape Rolls

- Brightly visible ■ Inexpensive ■ Reusable ■ Residential/Commercial use
- Directs immediate attention to safety areas

TAPE SIZE: 3" x 300'
ROLL SIZE: 3" x 4.25"
PACK: 6 EACH
WEIGHT: 6.04 LBS.
COLOR: YELLOW OR RED (*)

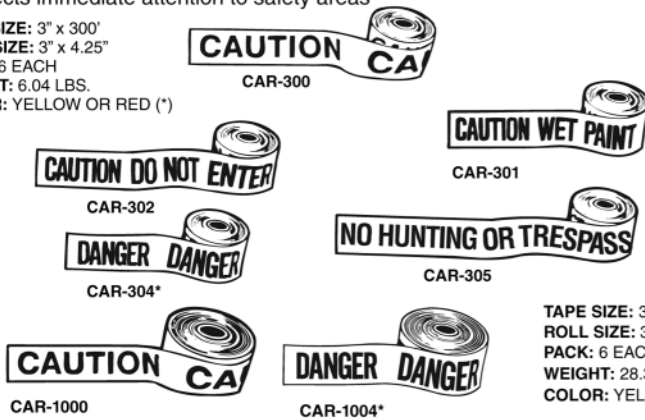

TAPE SIZE: 3" x 1000'
ROLL SIZE: 3" x 7.50"
PACK: 6 EACH
WEIGHT: 28.32 LBS.
COLOR: YELLOW OR RED (*)

Vinyl Flagging/Surveying Tape Rolls

- Weather-resistant, durable vinyl ■ Used by utility companies, service departments, police departments, construction crews, etc.

BULK TAPES-FLUORESCENT

TAPE SIZE: 1.19" x 150'
ROLL SIZE: 1.19" x 3.50"
PACK: 12 EACH
WEIGHT: 3.70 LBS.

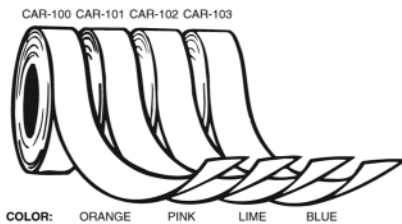

12"-18"-28"-36" Triangular Day-Glo Vinyl Traffic Safety Cones

- Flexible, yet durable ■ High visibility ■ Choose from four different sizes ■ Engineered to meet MUTCD specifications

SC-12

HEIGHT: 12"
SIZE: 12" x 9"
WEIGHT: 10.34 LBS.
PACK: 6 EACH

SC-18

HEIGHT: 18"
SIZE: 18" x 11.25"
WEIGHT: 22.16 LBS.
PACK: 6 EACH

SC-28

HEIGHT: 28"
SIZE: 28" x 13.13"
WEIGHT: 36.80 LBS.
PACK: 6 EACH

SC-36

HEIGHT: 36"
SIZE: 36" x 15.5"
WEIGHT: 41 LBS.
PACK: 3 EACH

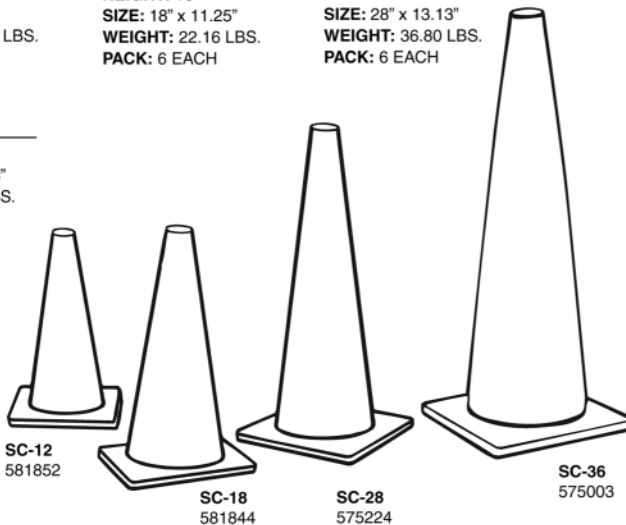

2" x 24" Reflective Vinyl Safety Tapes

- Self-adhesive ■ Weather-resistant
- Highly visible ■ Mark designated areas for safety purposes ■ Used to mark items for easy visibility (Mailbox, Fire Extinguisher, Stairway, Commercial Vehicles)

TAPE SIZE: 2" x 24" **WEIGHT:** .30 LBS.
PACK: 5 EACH



20" Corrugated Plastic Safety Floor Stands

- Made of heavy-duty, corrugated plastic
- Message printed on both sides
- Attractive and eye catching
- Directs attention to hazardous areas

HEIGHT: 20"
SIZE: 20.25" x 12.25"
PACK: 5 EACH
WEIGHT: 4.26 LBS.
COLOR: YELLOW/BLACK



Standard Aluminum Markers

- Rustproof and strong
- Molded head on twisted aircraft-grade aluminum rod
- Brilliant break-resistant plexiglas reflector
- Display on pegboard or display merchandiser

DM100R36 OR B36
 HEIGHT: 36"
 COLOR: RED OR BLUE
 SIZE: 37" x 10.50"
 PACK: 24 EACH
 WEIGHT: 6.50 LBS.

DM100R48 OR B48
 HEIGHT: 48"
 COLOR: RED OR BLUE
 SIZE: 48.75" x 10.50"
 PACK: 24 EACH
 WEIGHT: 7.68 LBS.

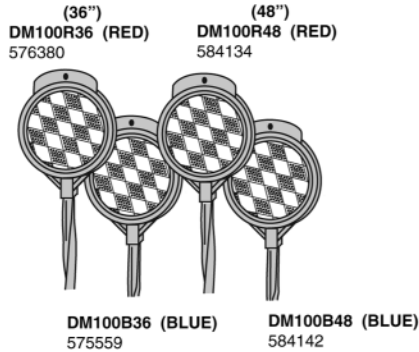

Fiberglass Safety Markers

- Made of durable fiberglass
- 4 1/2" of Reflective tape is wrapped around each marker
- Visible from all angles
- Rubber tip at the top protects end
- Use for any purpose to attract attention to specific area

DM85048 591718
 HEIGHT: 48"
 COLOR: YELLOW
 WEIGHT: 9 LBS.

DM80048 591726
 HEIGHT: 48"
 COLOR: ORANGE
 WEIGHT: 9 LBS.

DM80072 591696
 HEIGHT: 72"
 COLOR: ORANGE
 WEIGHT: 13 LBS.

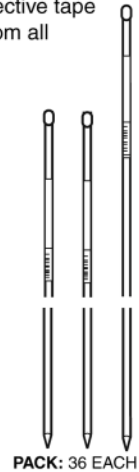

Carded Reflectors

- Made of break-resistant plexiglas
- Skin-packed on attractive cards
- Display on pegboard or revolving display rack

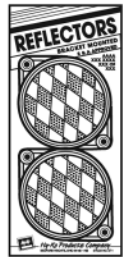

CDRF-3R (RED) 577197
CDRF-3B (BLUE) 582174

BRACKETED NAIL-ON REFLECTORS
 CARD SIZE: 9.63" x 4.88"
 COLOR: RED OR BLUE
 DIAMETER: 3 1/4"
 PACK: 12 EACH
 WEIGHT: 1.64 LBS.

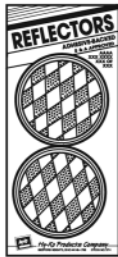

CDRF-4R (RED) 577200
CDRF-4B (BLUE) 582182

SELF-ADHESIVE PRESS-ON REFLECTORS
 CARD SIZE: 9.63" x 4.88"
 COLOR: RED OR BLUE
 DIAMETER: 3 1/4"
 PACK: 12 EACH
 WEIGHT: 1.12 LBS.

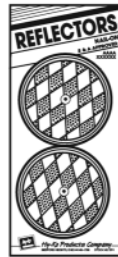

CDRF-5R (RED) 577081
CDRF-5B (BLUE) 582190

NAIL-ON REFLECTORS
 CARD SIZE: 9.63" x 4.88"
 COLOR: RED OR BLUE
 DIAMETER: 3 1/4"
 PACK: 12 EACH
 WEIGHT: 1.02 LBS.

24" Vinyl Safety/Boundary Stake Flags

- Four different day-glow colors to choose from
- High-visibility
- Marks underground wires/pipes/cables
- Reusable

SF-24
 HEIGHT: 24"
 BUNDLE SIZE: 1.50" x 24"
 SIZE: 6.75" x 26.75"
 WEIGHT: 26.74 LBS.
 PACK: 10 BUNDLES (100 FLAGS PER BUNDLE)

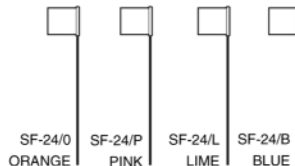

Self-Adhesive Vinyl Industrial Sign

- Commercial/Industrial use

THIS DOOR TO REMAIN UNLOCKED WHILE BUILDING IS OCCUPIED CV-2
 PANEL SIZE: 1.50" x 30.5" SIZE: 1.50" x 28" PACK: 10 EACH
 WEIGHT: .02 LBS. COLOR: BLACK & WHITE

Aluminum or Vinyl Slow-Moving Vehicle Emblems

- Bright colors for visibility & safety



COLORS: RED/ORANGE

TA-1
 ALUMINUM EMBLEM
 SIZE: 16" x 14"
 PACK: 12 EACH
 WEIGHT: 7.72 LBS.

TD-2
 VINYL EMBLEM DECAL
 SIZE: 13.75" x 15.75"
 PACK: 12 EACH
 WEIGHT: 1.36 LBS.

High Visibility SMV Emblems

- 10X more reflective
- Meets ASAE S276.5 Standard

TA-5
 ALUMINUM EMBLEM
 SIZE: 16" x 14"
 PACK: 3 EACH
 WEIGHT: 1.98 LBS.

TD-5
 VINYL EMBLEM DECAL
 SIZE: 13.75" x 15.75"
 PACK: 3 EACH
 WEIGHT: .50 LBS.

50' Multicolored Polyethylene Pennant Flags

- 22 - 11" x 18.5" V-shaped pennants
- Contains 6 colors (Red, White, Blue, Yellow, Green & Orange)
- Weather-resistant poly plastic material

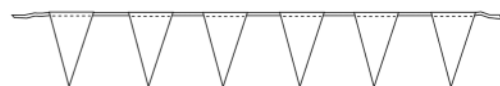

SIZE: 3.50" x 20.5" PACK: 10 EACH
 WEIGHT: .54 LBS. COLOR: MULTIPLE

PEN-3

Parking Lot Stencils

■ Easy to mark parking lot surface ■ Reusable, heavy-duty plastic

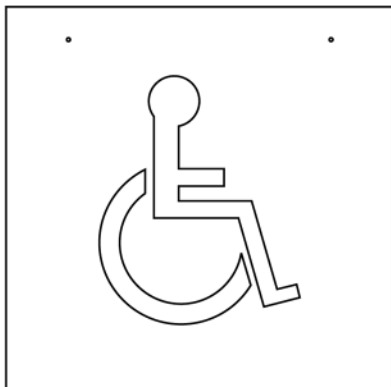

PLS-50

PLS-50

STENCIL SIZE: 24.5" x 24.5"
 SIZE: 18" IMAGE SIZE
 PACK: 5 EACH
 WEIGHT: 5.6 LBS.



PLS-51



PLS-52



PLS-53



PLS-54

PLS-51, 52, -53, -54

STENCIL SIZE: 5" x 24"
 SIZE: 3" LETTERING
 PACK: 5 EACH
 WEIGHT: 1.5 LBS.

1"- 2"- 3"- 4"- 5"- 6" Carded Number & Letter Stencils

■ Attractive blister-carded stencils ■ Reusable/Flexible ■ Made of heavy duty stencil board ■ Water-resistant ■ Includes numbers 0 thru 9; letters A thru Z; Symbols (Period, Dash, Comma, ¢, &, \$ and one extra A, E, O, R and S)

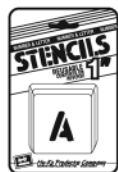

ST-1 248797

STENCIL SIZE: 1"
 CARD SIZE: 3.75" x 5.88"
 WEIGHT: .92 LBS.



ST-2 248800

STENCIL SIZE: 2"
 CARD SIZE: 3.75" x 6.88"
 WEIGHT: 1.62 LBS.

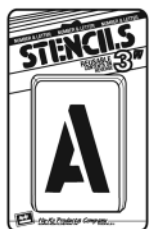

ST-3 248819

STENCIL SIZE: 3"
 CARD SIZE: 4.75" x 7.88"
 WEIGHT: 2.50 LBS.



ST-4 248827

STENCIL SIZE: 4"
 CARD SIZE: 5.75" x 9.88"
 WEIGHT: 4.12 LBS.



ST-5 248835

STENCIL SIZE: 5"
 CARD SIZE: 5.75" x 10.88"
 WEIGHT: 5.12 LBS.



ST-6 248843

STENCIL SIZE: 6"
 CARD SIZE: 6.75" x 11.88"
 WEIGHT: 6.54 LBS.

PACK: 6 EACH

Vinyl Glow-In-The-Dark Safety Signs

■ Self-adhesive ■ Meets most safety requirements ■ Phosphorescent material has a non-radioactive chemical which glows in total darkness after exposure to a light source ■ Up to 8 hours visibility



EE-2

PANEL SIZE: 8" x 11"
 SIZE: 8" x 10" with
 6" Letters
 WEIGHT: .92 LBS.



EE-3 246069

PANEL SIZE: 11" x 12"
 SIZE: 10" x 12" with
 8" Letters
 WEIGHT: 1.36 LBS.



FA-1 248711

PANEL SIZE: 4" x 11"
 SIZE: 4" x 10"
 WEIGHT: .42 LBS.



FE-2L 248738

PANEL SIZE: 4" x 11"
 SIZE: 4" x 10"
 WEIGHT: .42 LBS.



FE-2R 248746

PANEL SIZE: 4" x 11"
 SIZE: 4" x 10"
 WEIGHT: .42 LBS.



FE-1 242985

PANEL SIZE: 4" x 19"
 SIZE: 4" x 18"
 WEIGHT: .74 LBS.



FH-1

PANEL SIZE: 4" x 19"
 SIZE: 4" x 18"
 WEIGHT: .74 LBS.

PACK: 10 EACH
 COLOR: RED/DAYGLO

Heavy-Duty Plastic Deco Designer Graphic Signs

- Indoor/Outdoor use ■ Wipe clean, polished finish ■ Easy to read ■ Self-adhesive strips for easy mounting
- Use in offices, factories, restaurants, hospitals, hotels, etc.

3" x 9" Deco Signs

SIZE: 3" x 9" PACK: 5 EACH WEIGHT: .50 LBS. COLOR : BROWN/OFF-WHITE

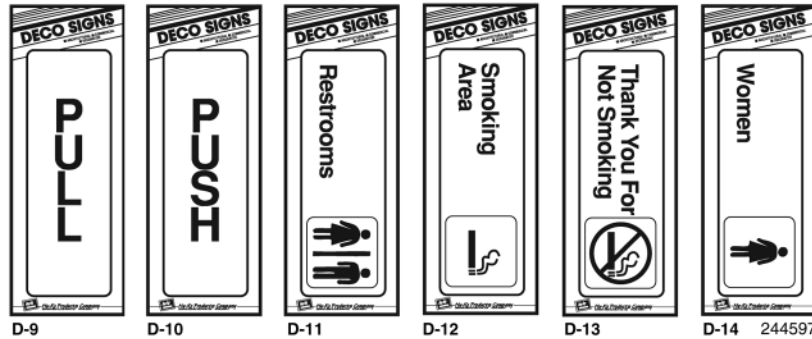
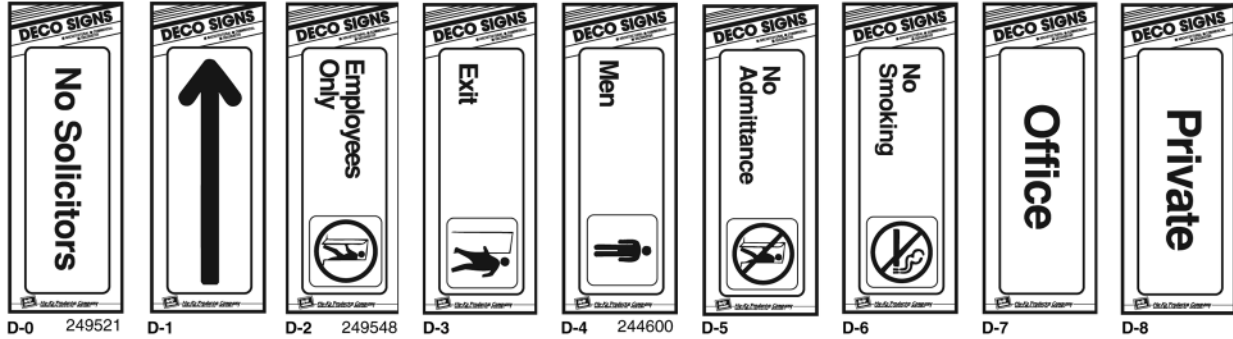

2" x 8" Self-Adhesive Vinyl Fuel Labels

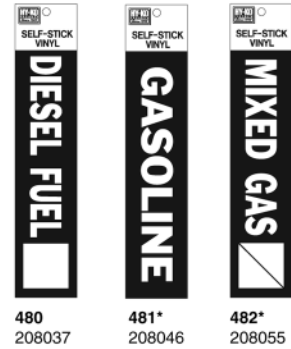

5" x 7" Deco Signs



SIZE: 2" x 8"
PACK: 10 EACH
WEIGHT: .080 LBS.
COLOR: GREEN
or RED*

Vinyl Graphic Sign



SIZE: 5" x 7"
PACK: 5 EACH
WEIGHT: .66 LBS.
COLOR: MULTIPLE

SIZE: 7" x 10"
PACK: 10 EACH
WEIGHT: .34 LBS.
COLOR: MULTIPLE

2" x 8" Press-On Aluminum Princess Signs ■ Brushed aluminum finish



SIZE: 2.13" x 8.50" PACK: 10 EACH WEIGHT: .20 LBS. COLOR: BLACK or RED (*)

Heavy Duty Plastic Braille/Tactile Designer Graphic Signs

6" x 9" Braille/Tactile Signs ■ Meets ADA (Americans with Disabilities Act) Requirements

CARD SIZE: 7" x 11.75" SIZE: 6" x 9" PACK: 3 EACH WEIGHT: .70 LBS. COLOR: BLACK/WHITE

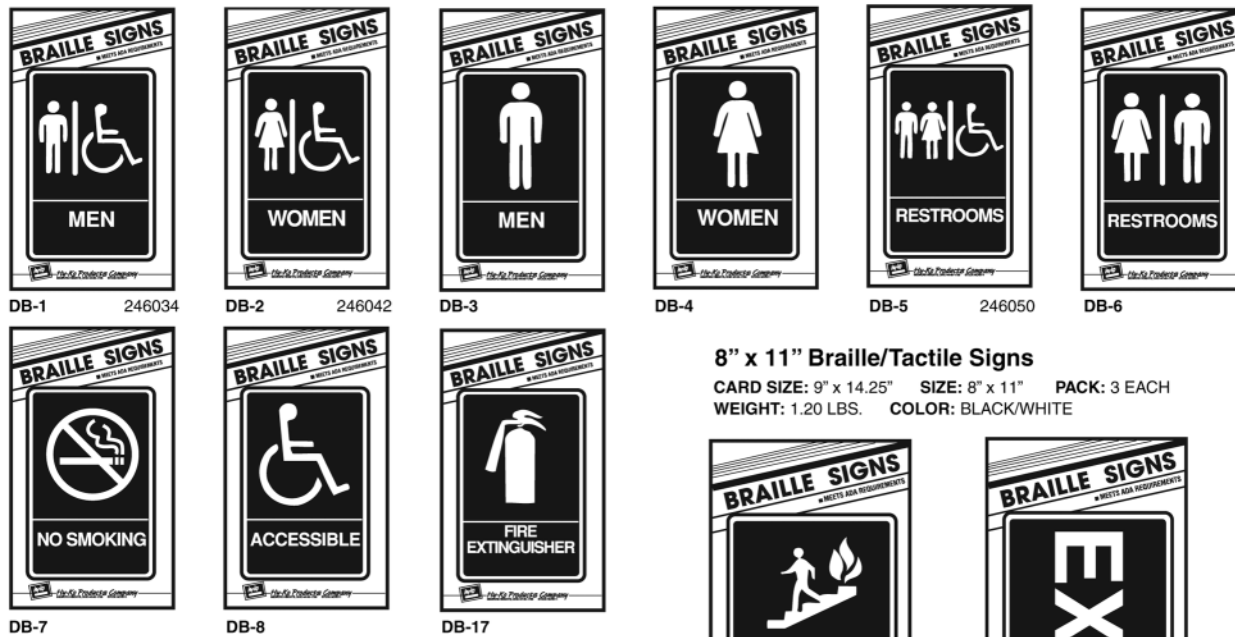

8" x 11" Braille/Tactile Signs

CARD SIZE: 9" x 14.25" SIZE: 8" x 11" PACK: 3 EACH WEIGHT: 1.20 LBS. COLOR: BLACK/WHITE

ADA/Title 24 Plastic Signs

■ Meets ADA (Americans with Disabilities Act) Requirements
 ■ Contrasting blue & bright white finish ■ Self-adhesive



CARD SIZE: 13" x 15.75"
 SIZE: 12" x 12"
 PACK: 3 EACH
 WEIGHT: 1.80 LBS.
 COLOR: BLUE/WHITE

10" x 14" Aluminum Exit Signs

■ Weather-Resistant ■ Durable ■ Meets many safety, building and fire department codes



SS-2W 246026



SS-7



SS-9

SIZE: 10" x 14"
PACK: 12 EACH
WEIGHT: 1.96 LBS.
COLOR: RED/WHITE

10" x 14" Aluminum Commercial Hy-Glo Signs

■ Pre-punched mounting holes ■ Rounded corners ■ Weather-resistant ■ Attractive and eye catching



801 202998



802 203005



804 204674



805 204727



806 204781



807 204941



808 202290



810



811 212102



813 219837



820 * (Reversible Sign) 245941



824



826



830



831 245968



833 245976



834



837



838 245984



842



848 246018



861



862



865



866 230459



868

SIZE: 10" x 14"
PACK: 12 EACH
WEIGHT: 1.96 LBS.
COLOR: ORANGE/BLACK

15" x 19" Plastic Commercial Hy-Glo Signs

■ Weather-resistant ■ Larger for greater visibility ■ Attractive and eye catching

SIZE: 15" x 19" PACK: 5 EACH WEIGHT: 1.50 LBS. COLOR: ORANGE/BLACK



SP-100 227793



SP-102 228694



SP-104 228970



SP-105 229675



SP-106 229700



SP-107 230164



SP-115



SP-117



SP-151



SP-152

HARDWARE

HARDWARE

Hy-Ko Prod.

Boat Number And Letter Assortment - 3" size letters and numbers. Specifically designed for Marine use. 16-7/8" H. x 7-3/4" W. Self-adhesive. Black characters on white background. Skin packed.



Product No.	Mfg. No.	Description	Order Mult.	Weight	Unit Cost
203912-D	MM-4L57	3" Assortment Letters	1/0/10	.110	2.79 EA
203904-E	MM-4N26	3" Assortment Numbers	1/0/10	.140	2.29 EA

Hy-Ko Prod.

2" Reflective Numbers, Letters, And Symbols - Bend and peel reflective vinyl. Self-adhesive. Long-lasting, weather-resistant. Commercial. Residential. 2" black figure on white reflective vinyl.



Product No.	Mfg. No.	Description	Order Mult.	Weight	Unit Cost
219894-E	RV-25/A	2" Reflect Letter A	0/0/10	.002	.59 EA
219967-E	RV-25/B	2" Reflect Letter B	0/0/10	.002	.59 EA
220000-E	RV-25/C	2" Reflect Letter C	0/0/10	.002	.59 EA
220043-E	RV-25/D	2" Reflect Letter D	0/0/10	.002	.59 EA
220132-E	RV-25/E	2" Reflect Letter E	0/0/10	.002	.59 EA
220140-E	RV-25/F	2" Reflect Letter F	0/0/10	.002	.59 EA
220159-E	RV-25/G	2" Reflect Letter G	0/0/10	.002	.59 EA
220167-E	RV-25/H	2" Reflect Letter H	0/0/10	.002	.59 EA
220183-E	RV-25/I	2" Reflect Letter I	0/0/10	.002	.59 EA
220191-E	RV-25/J	2" Reflect Letter J	0/0/10	.002	.59 EA
220205-E	RV-25/K	2" Reflect Letter K	0/0/10	.002	.59 EA
220213-E	RV-25/L	2" Reflect Letter L	0/0/10	.002	.59 EA
220221-E	RV-25/M	2" Reflect Letter M	0/0/10	.002	.59 EA
220248-E	RV-25/N	2" Reflect Letter N	0/0/10	.002	.59 EA
220256-E	RV-25/P	2" Reflect Letter P	0/0/10	.002	.59 EA
220264-E	RV-25/Q	2" Reflect Letter Q	0/0/10	.002	.59 EA
220272-E	RV-25/R	2" Reflect Letter R	0/0/10	.002	.59 EA
220280-E	RV-25/S	2" Reflect Letter S	0/0/10	.002	.59 EA
220299-E	RV-25/T	2" Reflect Letter T	0/0/10	.002	.59 EA
220302-E	RV-25/U	2" Reflect Letter U	0/0/10	.002	.59 EA
220426-E	RV-25/V	2" Reflect Letter V	0/0/10	.002	.59 EA
220434-E	RV-25/W	2" Reflect Letter W	0/0/10	.002	.59 EA
220442-E	RV-25/X	2" Reflect Letter X	0/0/10	.002	.59 EA
220450-E	RV-25/Y	2" Reflect Letter Y	0/0/10	.002	.59 EA
220469-E	RV-25/Z	2" Reflect Letter Z	0/0/10	.002	.59 EA
219703-E	RV-25/0	2" Reflect Number 0	0/0/10	.002	.59 EA
219738-E	RV-25/1	2" Reflect Number 1	0/0/10	.002	.59 EA
219746-E	RV-25/2	2" Reflect Number 2	0/0/10	.002	.59 EA
219754-E	RV-25/3	2" Reflect Number 3	0/0/10	.002	.59 EA
219762-E	RV-25/4	2" Reflect Number 4	0/0/10	.002	.59 EA
219770-E	RV-25/5	2" Reflect Number 5	0/0/10	.002	.59 EA
219789-E	RV-25/6	2" Reflect Number 6	0/0/10	.002	.59 EA
219797-E	RV-25/7	2" Reflect Number 7	0/0/10	.002	.59 EA
219851-E	RV-25/8	2" Reflect Number 8	0/0/10	.002	.59 EA
219878-E	RV-25/9	2" Reflect Number 9	0/0/10	.002	.59 EA
220477-E	RV-25/-	2" Reflect Period	0/0/10	.002	.59 EA
220566-E	RV-25/&	2" Reflect Ampersand	0/0/10	.002	.59 EA
220574-E	RV-25/-	2" Reflect Hyphen	0/0/10	.002	.59 EA
220582-E	RV-25/BLNK	2" Reflect Blank	0/0/10	.002	.59 EA

LETTERS/NUMBERS

Hy-Ko Prod.

3" Reflecting Numbers And Letters - For marking boats, trucks, recreational vehicles, snowmobiles, 3" figure on 4" reflective panel. Weather-resistant. Self-adhesive. Black characters on white reflective background. Coast Guard Approved. 10 per pack.



Product No.	Mfg. No.	Description	Order Mult.	Weight	Unit Cost
204471-D	RV-50/BL	3" Reflect Blank	0/0/10	.003	.69 EA
204498-D	RV-50/AM	3" Reflect Ampersand	0/0/10	.003	.69 EA
204501-D	RV-50/PE	3" Reflect Period	0/0/10	.003	.69 EA
204528-D	RV-50/HY	3" Reflect Hyphen	0/0/10	.003	.69 EA
204544-D	RV-50-0	3" Reflect Number 0	0/0/10	.003	.69 EA
204536-D	RV-50-1	3" Reflect Number 1	0/0/10	.003	.69 EA
204552-D	RV-50-2	3" Reflect Number 2	0/0/10	.003	.69 EA
204560-D	RV-50-3	3" Reflect Number 3	0/0/10	.003	.69 EA
204579-D	RV-50-4	3" Reflect Number 4	0/0/10	.003	.69 EA
204587-D	RV-50-5	3" Reflect Number 5	0/0/10	.003	.69 EA
204595-D	RV-50-6	3" Reflect Number 6	0/0/10	.003	.69 EA
204609-D	RV-50-7	3" Reflect Number 7	0/0/10	.003	.69 EA
204617-D	RV-50-8	3" Reflect Number 8	0/0/10	.003	.69 EA
204625-D	RV-50-9	3" Reflect Number 9	0/0/10	.003	.69 EA
204633-D	RV-50A	3" Reflect Letter A	0/0/10	.003	.69 EA
204641-D	RV-50B	3" Reflect Letter B	0/0/10	.003	.69 EA
204668-D	RV-50C	3" Reflect Letter C	0/0/10	.003	.69 EA
204676-D	RV-50D	3" Reflect Letter D	0/0/10	.003	.69 EA
204684-D	RV-50E	3" Reflect Letter E	0/0/10	.003	.69 EA
204706-D	RV-50F	3" Reflect Letter F	0/0/10	.003	.69 EA
204714-D	RV-50G	3" Reflect Letter G	0/0/10	.003	.69 EA
204722-D	RV-50H	3" Reflect Letter H	0/0/10	.003	.69 EA
204730-D	RV-50I	3" Reflect Letter I	0/0/10	.003	.69 EA
204749-D	RV-50J	3" Reflect Letter J	0/0/10	.003	.69 EA
204757-D	RV-50K	3" Reflect Letter K	0/0/10	.003	.69 EA
204765-D	RV-50L	3" Reflect Letter L	0/0/10	.003	.69 EA
204773-D	RV-50M	3" Reflect Letter M	0/0/10	.003	.69 EA
204803-D	RV-50N	3" Reflect Letter N	0/0/10	.003	.69 EA
204838-D	RV-50P	3" Reflect Letter P	0/0/10	.003	.69 EA
204846-D	RV-50Q	3" Reflect Letter Q	0/0/10	.003	.69 EA
204854-D	RV-50R	3" Reflect Letter R	0/0/10	.003	.69 EA
204862-D	RV-50S	3" Reflect Letter S	0/0/10	.003	.69 EA
204889-D	RV-50T	3" Reflect Letter T	0/0/10	.003	.69 EA
204897-D	RV-50U	3" Reflect Letter U	0/0/10	.003	.69 EA
204900-D	RV-50V	3" Reflect Letter V	0/0/10	.003	.69 EA
204919-D	RV-50W	3" Reflect Letter W	0/0/10	.003	.69 EA
204927-D	RV-50X	3" Reflect Letter X	0/0/10	.003	.69 EA
204935-D	RV-50Y	3" Reflect Letter Y	0/0/10	.003	.69 EA
204943-D	RV-50Z	3" Reflect Letter Z	0/0/10	.003	.69 EA

Hy-Ko Prod.

Numbers And Letters - Made of polyester film. Skin packed, colorful eye-catching cards. Unlimited uses in hardware, home improvement, stationery, and sporting goods departments.



Product No.	Mfg. No.	Description	Order Mult.	Weight	Unit Cost
200561-E	MM2	Assortment consists of 96 - 1" letters and numbers, gold characters on black background	1/0/10	.113	2.29 CD
201105-D	MM3N	Assortment consists of 24 - 2" numbers, gold characters on black background	1/0/10	.113	1.99 CD
201310-D	MM3L	Assortment consists of 54 - 2" letters, gold characters on black background	1/0/10	.138	2.99 CD

Continued Next Column

LETTERS/NUMBERS

HARDWARE

Continued From Previous Column

Product No.	Mfg. No.	Description	Order Mult.	Weight	Unit Cost
205584-D	MM-5N	Assortment consists of 26 - 3" numbers, gold characters on black background	1/0/10	.100	3.49 EA
246115-E	MM-6	Assortment consists of 114 - 1" letters and numbers, black characters on white background	1/0/10	.078	2.29 CD
246123-D	MM-7L	Assortment consists of 61 - 2" letters, black characters on white background	1/0/10	.106	2.99 CD
246131-D	MM-7N	Assortment consists of 33 - 2" numbers, black characters on white background	1/0/10	.082	1.99 CD
249513-E	MM-100	3/4" numbers, black characters on white background	1/0/10	.082	2.29 CD

Continued From Previous Column

Product No.	Mfg. No.	Description	Order Mult.	Weight	Unit Cost
235156-D	GB-7/Q	7" Poly Letter Q	1/0/3	.313	2.99 EA
235164-D	GB-7/R	7" Poly Letter R	1/0/3	.313	2.99 EA
235172-D	GB-7/S	7" Poly Letter S	1/0/3	.313	2.99 EA
235180-D	GB-7/T	7" Poly Letter T	1/0/3	.313	2.99 EA
235199-D	GB-7/U	7" Poly Letter U	1/0/3	.313	2.99 EA
235202-D	GB-7/V	7" Poly Letter V	1/0/3	.313	2.99 EA
235210-D	GB-7/W	7" Poly Letter W	1/0/3	.313	2.99 EA
235229-D	GB-7/X	7" Poly Letter X	1/0/3	.313	2.99 EA
235237-D	GB-7/Y	7" Poly Letter Y	1/0/3	.313	2.99 EA
235245-D	GB-7/Z	7" Poly Letter Z	1/0/3	.313	2.99 EA

Hy-Ko Prod.

4" Solid Brass 3-D House Numbers - Attractive solid polished brass. Mounting screws included. Numbers 0 thru 9.



Hy-Ko Prod.

Number And Letter Stencils - Made of heavy-duty stencil board. Reusable, flexible, water-resistant. Includes numbers 0 thru 9; letters A thru Z; symbols, period, dash, comma, cents, &, \$, and 1 extra A, E, O, R, and S. 1" thru 6".

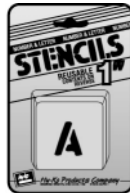

Product No.	Mfg. No.	Description	Order Mult.	Weight	Unit Cost
248797-E	ST-1	1"	1/0/6	.153	2.29 PK
248800-E	ST-2	2"	1/0/6	.270	2.79 PK
248819-E	ST-3	3"	1/0/6	.417	4.29 PK
248827-E	ST-4	4"	1/0/36	.687	5.49 PK
248835-E	ST-5	5"	1/0/6	.853	6.79 PK
248843-E	ST-6	6"	1/0/6	1.090	8.29 PK

Product No.	Mfg. No.	Description	Order Mult.	Weight	Unit Cost
254770-D	BR-90/0	4"solid Brs 3-d Number 0	1/0/5	.100	4.79 EA
254789-D	BR-90/1	4"solid Brs 3-d Number 1	1/0/5	.100	4.79 EA
254797-D	BR-90/2	4"solid Brs 3-d Number 2	1/0/5	.100	4.79 EA
254800-D	BR-90/3	4"solid Brs 3-d Number 3	1/0/5	.100	4.79 EA
254819-D	BR-90/4	4"solid Brs 3-d Number 4	1/0/5	.100	4.79 EA
254827-C	BR-90/5	4"solid Brs 3-d Number 5	1/0/5	.100	4.79 EA
254835-D	BR-90/6	4"solid Brs 3-d Number 6	1/0/5	.100	4.79 EA
254843-D	BR-90/7	4"solid Brs 3-d Number 7	1/0/5	.100	4.79 EA
254851-D	BR-90/8	4"solid Brs 3-d Number 8	1/0/5	.100	4.79 EA
254878-D	BR-90/9	4"solid Brs 3-d Number 9	1/0/5	.100	4.79 EA

Hy-Ko Prod.

Signs - Hy-glo plastic, 9" x 12". White durable plastic. Brilliant fluorescent lettering. Black background. Weatherproof.



Hy-Ko Prod.

7" Poly Numbers And Letters - Manufactured of quality plastic. Decorative numbers and letters for indoor or outdoor use. Woodgrain texture, pre-drilled, can be used as they are or can be painted, stained, or antiqued.



Product No.	Mfg. No.	Description	Order Mult.	Weight	Unit Cost
234877-D	GB-7/0	7" Poly Number 0	1/0/3	.313	2.99 EA
234885-D	GB-7/1	7" Poly Number 1	1/0/3	.313	2.99 EA
234893-D	GB-7/2	7" Poly Number 2	1/0/3	.313	2.99 EA
234907-D	GB-7/3	7" Poly Number 3	1/0/3	.313	2.99 EA
234915-D	GB-7/4	7" Poly Number 4	1/0/3	.313	2.99 EA
234923-D	GB-7/5	7" Poly Number 5	1/0/3	.313	2.99 EA
234931-D	GB-7/6	7" Poly Number 6	1/0/3	.313	2.99 EA
234958-D	GB-7/7	7" Poly Number 7	1/0/3	.313	2.99 EA
234966-D	GB-7/8	7" Poly Number 8	1/0/3	.313	2.99 EA
234974-D	GB-7/9	7" Poly Number 9	1/0/3	.313	2.99 EA
234982-D	GB-7/A	7" Poly Letter A	1/0/3	.313	2.99 EA
234990-D	GB-7/B	7" Poly Letter B	1/0/3	.313	2.99 EA
235008-D	GB-7/C	7" Poly Letter C	1/0/3	.313	2.99 EA
235016-D	GB-7/D	7" Poly Letter D	1/0/3	.313	2.99 EA
235024-D	GB-7/E	7" Poly Letter E	1/0/3	.313	2.99 EA
235032-D	GB-7/F	7" Poly Letter F	1/0/3	.313	2.99 EA
235040-D	GB-7/G	7" Poly Letter G	1/0/3	.313	2.99 EA
235059-D	GB-7/H	7" Poly Letter H	1/0/3	.313	2.99 EA
235067-D	GB-7/I	7" Poly Letter I	1/0/3	.313	2.99 EA
235075-D	GB-7/J	7" Poly Letter J	1/0/3	.313	2.99 EA
235083-D	GB-7/K	7" Poly Letter K	1/0/3	.313	2.99 EA
235091-D	GB-7/L	7" Poly Letter L	1/0/3	.313	2.99 EA
235105-D	GB-7/M	7" Poly Letter M	1/0/3	.313	2.99 EA
235113-D	GB-7/N	7" Poly Letter N	1/0/3	.313	2.99 EA
235148-D	GB-7/P	7" Poly Letter P	1/0/3	.313	2.99 EA

Continued Next Column

Product No.	Mfg. No.	Description	Order Mult.	Weight	Unit Cost
245631-F	3001	Apartment For Rent	0/0/10	.060	.89 EA
208242-F	3002	Beware Of Dog	0/0/10	.100	.89 EA
202304-F	3003	Exit	0/0/10	.100	.89 EA
205655-F	3005	For Rent	0/0/10	.100	.89 EA
205539-F	3006	For Sale	0/0/10	.100	.89 EA
220567-F	3007	For Sale By Owner	0/0/10	.100	.89 EA
205343-F	3010	Keep Out	0/0/10	.100	.89 EA
207546-F	3011	No Hunting-Trespassing	0/0/10	.100	.89 EA
207154-F	3012	No Parking	0/0/10	.100	.89 EA
206501-F	3013	No Smoking	0/0/10	.100	.89 EA
205664-F	3014	No Trespassing	0/0/10	.100	.89 EA
245658-F	3016	Private Property Keep Out	0/0/10	.060	.89 EA
225189-F	3021	No Hunting	0/0/10	.010	.89 EA
208126-F	3022	Keep Off The Grass	0/0/10	.060	.89 EA
222259-F	3023	Garage Sale	0/0/10	.100	.89 EA
245666-F	3025	Private Property No Trespassing	0/0/10	.060	.89 EA
245674-F	3028	Private Drive	0/0/10	.060	.89 EA
245682-F	3030	Store Hours	0/0/10	.060	.89 EA
222240-F	3031	Auto For Sale	0/0/10	.100	.89 EA
245690-F	3033	Yard Sale	0/0/10	.060	.89 EA
245704-F	3034	Help Wanted	0/0/10	.060	.89 EA
245712-F	3036	No Loitering	0/0/10	.060	.89 EA
245720-F	3041	For Sale (black background with pink and green lettering)	0/0/10	.060	1.29 EA

We can become your single-source supplier on many of the products you currently use!

HARDWARE

Hy-Ko Prod.

For Lease - 9" x 12" plastic sign. Weather-resistant. Durable. Bright, attention-getting colors. Red on white background.



Product No.	Mfg. No.	Description	Order Mult.	Weight	Unit Cost
208162-E	20615	12x19 For Lease Sign	0/0/10	.060	.89 EA

Hy-Ko Prod.

For Sale By Owner Sign - Large custom design sign with mounting bracket. 20" x 24" weatherproof corrugated plastic with mounting bracket of black steel rod inserted between corrugated openings. White background with black lettering gives top visibility at long distances. Printed same on both sides. Each sign individually bagged with 1 bracket.



Product No.	Mfg. No.	Description	Order Mult.	Weight	Unit Cost
220576-D	LFS-1	For Sale By Owner	1/0/5	1.100	8.29 EA
207640-D	LGS-2	Garage Sale	1/0/5	1.100	8.29 EA

Hy-Ko Prod.

Fluorescent Signs - Meets safety, building, and fire department codes. White background with red lettering. 10" x 14". Aluminum.



Product No.	Mfg. No.	Description	Order Mult.	Weight	Unit Cost
246026-E	SS-2W	Exit	1/12/144	.169	1.49 EA
230440-E	SS-5	No Trespassing	1/12/144	.167	1.49 EA

Hy-Ko Prod.

Posted Legal Sign - Tyvek. Durable sign, tear-resistant. Yellow background with black lettering. Tyvek is a sheet of polyethylene fiber which is completely waterproof. 12" x 12".



Product No.	Mfg. No.	Description	Order Mult.	Weight	Unit Cost
200151-D	TV-2	Box of 50	0/0/50	.025	.59 EA
215325-D	TSR-100	Roll of 100	1/0/12	2.167	41.49 RL

LETTERS/NUMBERS

Hy-Ko Prod.

Signs - Heavy-gauge plastic. Durable and weatherproof. Yellow background with black lettering. 11" x 11".



Product No.	Mfg. No.	Description	Order Mult.	Weight	Unit Cost
200035-D	YP-1	Posted Legal	1/20/300	.150	.99 EA
246190-D	YP-2	For Sale	1/0/20	.115	.99 EA
246204-D	YP-3	Garage Sale	1/0/20	.115	.99 EA
246212-D	YP-7	No Trespassing	1/0/20	.115	.99 EA
246174-D	YP-10	Beware BadDog	1/0/20	.115	.99 EA
246182-D	YP-17	Safety Zone	1/0/20	.115	.99 EA

Hy-Ko Prod.

Deco Signs - 5" x 7" heavy-duty plastic deco designer graphic signs. White background with black lettering. Indoor/outdoor use. Easy-to-read. Self-adhesive strips for easy mounting.



Product No.	Mfg. No.	Description	Order Mult.	Weight	Unit Cost
244589-E	D-16	Fire Extinguisher	1/0/5	.132	4.49 EA
244570-E	D-17	Handicapped	1/0/5	.132	4.49 EA
244562-E	D-20	No Smoking	1/0/5	.132	4.49 EA
244554-E	D-23	Restrooms	1/0/5	.132	4.49 EA

Hy-Ko Prod.

OSHA Signs - 10" x 14" heavy-duty polyethylene. Durable, weather-resistant.



Product No.	Mfg. No.	Description	Order Mult.	Weight	Unit Cost
244473-E	501	Restricted Area	1/0/5	.275	2.99 EA
244481-E	507	Danger Hard Hat	1/0/5	.275	2.99 EA
244503-E	508	High Voltage	1/0/5	.280	2.99 EA
245852-E	512	Keep Out Danger	1/0/5	.264	2.99 EA
245860-E	515	Danger No Smoking	1/0/5	.264	2.99 EA
244511-E	520	Construction Area	1/0/5	.275	2.99 EA
244538-E	523	Danger	1/0/5	.260	2.99 EA
245879-E	540	Warning - Blank	1/0/5	.264	2.99 EA
245887-E	557	Caution Hazard Area	1/0/5	.264	2.99 EA
244546-E	562	Caution	1/0/5	.278	2.99 EA
245895-E	570	Safety First - Blank	1/0/5	.264	2.99 EA
245909-E	580	Notice - Blank	1/0/5	.264	2.99 EA

SIGNS

Hy-Ko Prod.

Self-Adhesive Fuel Safety Signs - 2" x 8" self-adhesive signs. Weather-resistant. Durable, bright and highly visible vinyl signs.



Product No.	Mfg. No.	Description	Order Mult.	Weight	Unit Cost
208037-B	480	Diesel Fuel	0/0/10	.008	.89 EA
208046-B	481	Gasoline	0/0/10	.008	.89 EA
208055-B	482	Mixed Gas	0/0/10	.008	.89 EA
208064-B	483	Kerosene	0/0/10	.008	.89 EA
208073-B	484	Flammable	0/0/10	.008	.89 EA

Hy-Ko Prod.

Signs - 15" x 19" heavy gauge plastic signs. Commercial grade plastic. Meets many local code requirements.



Product No.	Mfg. No.	Description	Order Mult.	Weight	Unit Cost
245933-D	700	Customer Parking	0/0/1	.128	5.29 EA
245917-D	701	Tenant Parking	0/0/1	.128	5.29 EA
245925-D	702	No Parking	0/0/1	.128	5.29 EA

Hy-Ko Prod.

Glow In The Dark Arrow Sign - Self-adhesive. Meets all safety requirements. Phosphorescent material has a nonradioactive chemical which glows in total darkness after exposure to a light source. Up to 8 hour visibility. Vinyl. Size 4" x 10".



Product No.	Mfg. No.	Description	Order Mult.	Weight	Unit Cost
248711-D	FA-1	4x10 Glo-n-dr Arrow Sign	1/0/10	.042	4.79 EA

Hy-Ko Prod.

Fire Extinguisher Sign - Meets all safety requirements. Self-adhesive. Phosphorescent material has a nonradioactive chemical which glows in total darkness after exposure to a light source. Up to 8 hours of visibility. 4" x 18".



Product No.	Mfg. No.	Description	Order Mult.	Weight	Unit Cost
242985-D	FE-1	4x18 Fire Extingher Sign	1/0/10	.074	5.99 EA

HARDWARE

Hy-Ko Prod.

Glow In The Dark Fire Extinguisher Sign - Self-adhesive. Meets all safety requirements. Phosphorescent material has a nonradioactive chemical which glows in total darkness after exposure to a light source. Up to 8 hour visibility. Vinyl. Size 4" x 10".



Product No.	Mfg. No.	Description	Order Mult.	Weight	Unit Cost
248738-D	FE-2L	Left	1/0/10	.042	4.79 EA
248746-D	FE-2R	Right	1/0/10	.042	4.79 EA

Hy-Ko Prod.

Signs - 3" x 9" heavy-duty plastic deco designer graphic signs. White background with black lettering. Indoor/outdoor use. Easy to read. Self-adhesive strips for easy mounting.



Product No.	Mfg. No.	Description	Order Mult.	Weight	Unit Cost
249521-E	D-0	No solicitors	1/0/5	.100	4.49 EA
249548-E	D-2	Employees only	1/0/5	.100	4.49 EA
244600-E	D-4	Men	1/0/5	.100	4.49 EA
244597-E	D-14	Women	1/0/5	.100	4.49 EA

Hy-Ko Prod.

No Smoking Sign - Self-adhesive vinyl. 6.75" x 11". Weather-resistant and durable. Bright and highly visible.



Product No.	Mfg. No.	Description	Order Mult.	Weight	Unit Cost
246093-E	HSV-8	6-3/4x11 No Smoking Sign	0/0/10	.034	.99 EA

Hy-Ko Prod.

Braille Signs - Heavy-duty plastic 6" x 9" Braille/tactile signs. Meets ADA requirements. Grade 2 Braille lettering and graphics. Contrasting eggshell finish. Self-adhesive. Packaged for the customer to feel the contour of the sign.



Product No.	Mfg. No.	Description	Order Mult.	Weight	Unit Cost
246034-C	DB-1	Men Handicapped	1/0/3	.233	7.29 EA
246042-C	DB-2	Women Handicapped	1/0/3	.233	7.29 EA
246050-C	DB-5	Restrooms Handicapped	1/0/3	.233	7.29 EA

HARDWARE

HARDWARE

SIGNS

Hy-Ko Prod.

Highway Signs - 12" x 18". Manufactured of heavy-duty 20-gauge aluminum. Rustproof. Prepunched mounting holes. For traffic and parking control in residential and commercial areas.



Product No.	Mfg. No.	Description	Order Mult.	Weight	Unit Cost
224685-D	HW-1	No Parking Anytime	0/0/1	.875	13.49 EA
224693-D	HW-4	No Dumping Allowed	0/0/1	.875	13.49 EA
224707-D	HW-7	Caution Children At Play	0/0/1	.875	13.49 EA
224715-D	HW-10	Speed Limit 10 MPH	0/0/1	.875	13.49 EA
224723-D	HW-13	Handicapped Parking	0/0/1	.875	13.49 EA
224731-D	HW-23	Speed Limit 5 MPH	0/0/1	.875	13.49 EA
246107-D	HW-32	Reserved Parking	0/0/1	.600	13.49 EA

Hy-Ko Prod.

Highway Sign - 18" x 18". Manufactured of .050 aluminum. Rustproof. Prepunched mounting holes. For traffic control in residential and commercial areas.



Product No.	Mfg. No.	Description	Order Mult.	Weight	Unit Cost
224758-D	HW-31	12x18 Stop Hwy Sign	0/0/1	.875	28.49 EA

Hy-Ko Prod.

Real Estate Signs - 18" x 24" plastic, double-sided signs, rectangle, red background with white lettering.



Product No.	Mfg. No.	Description	Order Mult.	Weight	Unit Cost
248762-D	RS-603	For Rent	1/5/25	.668	7.49 EA
248789-D	RS-604	For Sale	1/5/25	.668	7.49 EA
248770-D	RS-605	For Sale By Owner	1/5/25	.668	7.49 EA

Hy-Ko Prod.

Heavy-Duty Sign Frame - 24-3/8" x 41", 1/4" thick steel. Glossy black finish. Suitable for mounting 18" x 24" signs. Includes bolts for sign mounting.

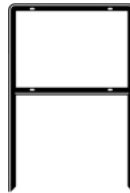

Product No.	Mfg. No.	Description	Order Mult.	Weight	Unit Cost
215988-D	FRAME-2	H/duty Sign Frame	1/0/5	6.696	21.49 EA

Hy-Ko Prod.

Heavy-Duty Sign Stake - 8" x 42" elongated black steel. 1/4" thick.



Product No.	Mfg. No.	Description	Order Mult.	Weight	Unit Cost
248754-E	FRAME-3	8x42 H/duty Sign Stake	1/0/5	3.620	11.79 EA

National Mfg.

Shelf Bracket - Cold-rolled steel. Electro-galvanized finish. Supplied less screws.



Product No.	Mfg. No.	Description	Order Mult.	Weight	Unit Cost
211087-C	N224436	3x4 Shelf Bracket	10/0/40	.078	.69 EA
211096-D	N224444	4x5 Shelf Bracket	10/0/50	.106	.89 EA
211103-D	N224451	5x6 Shelf Bracket	10/20/60	.197	1.29 EA
211121-D	N224469	6x8 Shelf Bracket	10/20/60	.260	1.79 EA
211149-C	N224477	8x10 Shelf Bracket	10/0/60	1.140	2.49 EA
211158-D	N224485	10x12 Shelf Bracket	10/0/60	1.600	3.29 EA
211167-C	N224493	12x14 Shelf Bracket	10/0/60	1.950	3.79 EA

National Mfg.

Shelf And Rod Bracket - Strong, 1-piece welded bracket. No hook strip needed. Rod bracket is made for 1-3/8" diameter pole. For shelves up to 4' long, use 2 brackets. For each additional 2' of shelving, add another bracket. Made for 12" shelves. White.

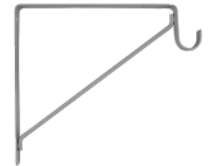

Product No.	Mfg. No.	Description	Order Mult.	Weight	Unit Cost
234829-D	N224428	Wht Shelf & Rod Bracket	1/0/20	1.300	3.29 EA

National Mfg.

Shelf Bracket - Catalog model No. 211 series. Steel. Unique girder-like construction gives exceptional strength. Brackets are sized to fit lumber dimensions. 6 screw holes per bracket. Lumber size: 4" x 6", 6" x 8", 8" x 10", 10" x 12", 12" x 14". Actual bracket size: 3" x 5", 5" x 7", 7" x 9", 9" x 11", 11" x 13". Available in gray, fruitwood, or white.



Product No.	Mfg. No.	Description	Order Mult.	Weight	Unit Cost
238022-D	N172601	4x6 Gray Shelf Bracket	1/20/100	.090	.49 EA
238031-C	N171066	6x8 Gray Shelf Bracket	1/20/200	.165	.49 EA
238040-C	N171074	8x10 Gray Shelf Bracket	1/20/140	.228	.59 EA
238059-C	N171082	10x12 Gray Shelf Bracket	1/0/20	.555	.99 EA
238068-C	N172619	12x14 Gray Shelf Bracket	1/0/20	.490	1.29 EA

Continued Next Column

SHELF BRACKET

HARDWARE

Continued From Previous Column

Product No.	Mfg. No.	Description	Order Mult.	Weight	Unit Cost
214043-D	N185017	4x6 Fw Shelf Bracket	1/20/60	.090	.49 EA
214035-D	N185025	6x8 Fw Shelf Bracket	1/20/80	.181	.59 EA
214000-C	N185033	8x10 Fw Shelf Bracket	1/20/60	.228	.69 EA
214019-D	N185041	10x12 Fw Shelf Bracket	1/0/20	.375	1.29 EA
214027-C	N185058	12x14 Fw Shelf Bracket	1/0/20	.480	1.49 EA
242497-D	N218891	6x8 Wht Shelf Bracket	1/20/80	.163	.79 EA
242500-C	N218925	8x10 Wht Shelf Bracket	1/20/60	.227	.89 EA
242519-D	N218958	10x12 Wht Shelf Bracket	1/0/20	.355	1.49 EA
200042-D	N245779	12x14 Wht Shelf Bracket	1/0/20	.490	1.79 EA

National Mfg.

Shelf And Rod Bracket - 1-piece shelf and rod bracket with adjustable support. 10" high, 12-1/2" projection, and 10-3/4" shelf support area. White.

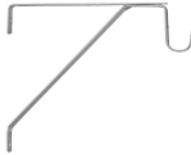

Product No.	Mfg. No.	Description	Order Mult.	Weight	Unit Cost
211354-C	N234971	Shelf & Rod Bracket	1/0/20	1.156	3.49 EA

National Mfg.

Shelf Bracket - Cold-rolled steel. Baked enamel. White painted finish. Designed for mounting shelves in closets, storage rooms, etc. 9-1/32" high. 10-3/8" projection.



Product No.	Mfg. No.	Description	Order Mult.	Weight	Unit Cost
249971-C	N234401	Wht Shelf Bracket	1/0/20	.934	3.29 EA

Knape & Vogt

Heavy-Duty Shelf Bracket - Holds up to 1000 lb. per pair. 5mm thick steel bar construction. White epoxy coat finish. Recommended fasteners (not included) are 3" or longer 5/16" lag screws mounted onto studs.



Product No.	Mfg. No.	Description	Order Mult.	Weight	Unit Cost
242772-C	208WH300	11-3/4" x 8-1/4" x 1-1/8"	1/0/10	1.900	5.49 EA
242780-C	208WH400	15-1/2" x 10-1/2" x 1-1/8"	1/0/10	2.600	6.79 EA
242799-D	208WH500	19-1/2" x 13" x 1-1/8"	1/0/10	3.300	8.29 EA
203327-D	208WH550	21-1/2" x 14-1/2" x 1-1/8"	1/0/10	3.700	9.99 EA

A V F Inc

TV Mount - TV wall mount pivots at the wall. Platform swivels for easy viewing. Channel strip and wall plate hides the TV power cord. For 13" to 17" size TV. UL rated up to 66 lb. Powder-coated epoxy finish. Black.



Product No.	Mfg. No.	Description	Order Mult.	Weight	Unit Cost
224572-D	350B	Tv Mount	1/0/6	6.333	47.99 EA

A V F Inc

TV Mount - TV wall mount pivots at the wall. Platform swivels and tilts for easy viewing. Channel strip and wall plate hides the TV power cord. For 13" to 17" size TV. UL rated up to 66 lb. Powder-coated epoxy finish. Silver.



Product No.	Mfg. No.	Description	Order Mult.	Weight	Unit Cost
224581-D	350S	Tv Mount	1/0/6	6.333	47.99 EA

A V F Inc

TV Wall Mount - TV wall mount pivots at the wall. Platform swivels and tilts for easy viewing. Channel strip and wall plate hides the TV power cord. For 13" to 17" size TV. UL rated up to 110 lb. Powder-coated epoxy finish. Black.



Product No.	Mfg. No.	Description	Order Mult.	Weight	Unit Cost
224590-D	750B	Tv Mount	1/0/6	12.333	59.99 EA

A V F Inc

TV Wall Mount - TV wall mount pivots at the wall. Platform swivels and tilts for easy viewing. Channel strip and wall plate hides the TV power cord. For 13" to 17" size TV. UL rated up to 110 lb. Powder-coated epoxy finish. Silver.



Product No.	Mfg. No.	Description	Order Mult.	Weight	Unit Cost
224596-D	750S	Tv Mount	1/0/6	12.333	59.99 EA

A V F Inc

TV And VCR Wall Mount - TV wall mount pivots at the wall. Platform swivels and tilts for easy viewing. Component mount fits neatly under the TV platform. Channel strip and wall plate hides the TV power cord. For 13" to 21" size TV. UL rated up to 100 lb. adjustable component mount 10" to 18". Powder-coated epoxy finish. Black.



Product No.	Mfg. No.	Description	Order Mult.	Weight	Unit Cost
224607-B	650B	Tv/vcr Wall Mount	1/0/6	10.000	59.99 EA

HARDWARE

HARDWARE

SHELVING

A V F Inc

TV And VCR Wall Mount - TV wall mount pivots at the wall. Platform swivels and tilts for easy viewing. Component mount fits neatly under the TV platform. Channel strip and wall plate hides the TV power cord. For 13" to 21" size TV. UL rated up to 100 lb. adjustable component mount 10" to 18". Powder-coated epoxy finish. Black.



Product No.	Mfg. No.	Description	Order Mult.	Weight	Unit Cost
224616-B	650S	Tv/vcr Wall Mount	1/0/6	10.000	59.99 EA

A V F Inc

Heavy-Duty TV Mount - Heavy-duty TV mount arm pivots at the wall. Platform has 2-position downward tilt for easy positioning and viewing. Ideal for commercial locations like restaurants, schools, hotels, and hospitals. Reinforced steel tubing with exclusive clamp design. For TV size 19" to 27". UL rated up to 130 lb. Powder-coated epoxy. Black finish.



Product No.	Mfg. No.	Description	Order Mult.	Weight	Unit Cost
224626-B	850B	Hd Tv Mount	1/0/3	20.000	64.99 EA

A V F Inc

Ceiling TV Mount - Heavy-duty ceiling mount turns 360° independent of the platform. Platform has 2-position downward tilt for easy positioning and viewing. Ideal for commercial locations like restaurants, schools, hotels, and hospitals. Reinforced steel tubing with exclusive clamp design. For TV size 19" to 27". UL rated up to 130 lb. Powder-coated epoxy. Black finish.



Product No.	Mfg. No.	Description	Order Mult.	Weight	Unit Cost
224634-B	950B	Ceiling Tv Mount	1/0/3	11.000	64.99 EA

A V F Inc

VCR And DVD Mounting Bracket - Universal stackable bracket can be used with all AVF TV mounts. Suitable for VCR, DVD, cable box, or DSS receivers. Fully pivots 360° independently from the TV mount. For components from 10" to 18" in width, and 2.25" to 4" in height. Powder-coated epoxy. Black.



Product No.	Mfg. No.	Description	Order Mult.	Weight	Unit Cost
224650-C	P6138BP	Vcr/dvd Mounting Bracket	1/0/6	4.000	29.99 EA

A V F Inc

VCR And DVD Mounting Bracket - Universal stackable bracket can be used with all AVF TV mounts. Suitable for VCR, DVD, cable box, and DSS receivers. Fully pivots 360° independently from the TV mount. For components from 10" to 18" in width, and 2.25" to 4" in height. Powder-coated epoxy. Silver.



Product No.	Mfg. No.	Description	Order Mult.	Weight	Unit Cost
224652-C	P6138SP	Vcr/dvd Mounting Bracket	1/0/6	4.000	29.99 EA

A V F Inc

TV Fixed Wall Mount - LCD TV mount provides fixed operation. Maximum load: 33 lb. 75mm to 100mm VESA compatible plus adaptor plate for 5" x 4" centers. Lifetime warranty. Wall hardware included. For LCD TVs 15" to 22". Fully compatible with AVF cable cover system.



Product No.	Mfg. No.	Description	Order Mult.	Weight	Unit Cost
224698-B	LCD000	Lcd Tv Fixed Wall Mount	1/0/3	1.750	29.99 EA

A V F Inc

LCD Tilt Mount - LCD TV mount provides for tilt, swivel, and pivot operation. Maximum load: 33 lb. 75mm to 100mm VESA compatible plus adapter plate for 5" x 4" center. Lifetime warranty. Wall hardware included. For LCD TVs 15" to 22". Fully compatible with AVF cable cover system.



Product No.	Mfg. No.	Description	Order Mult.	Weight	Unit Cost
224705-B	LCD003	Lcd Tv Fixed Wall Mount	1/0/3	3.057	59.99 EA

A V F Inc

LCD Plasma TV Wall Mount - LCD retractable TV mount is perfect for the kitchen and allows the LCD TV to fold up securely out of the way when not in use. The mount folds down, tilts, and swivels 180° for optimum viewing. Installs in minutes. Maximum load: 33 lb. 75mm to 100mm VESA compatible. Lifetime warranty. Wall hardware included. For LCD TVs up to 15".



Product No.	Mfg. No.	Description	Order Mult.	Weight	Unit Cost
224714-C	LCD500	Lcd/plasma Tv Wall Mount	0/0/1	3.682	49.99 EA

A V F Inc

Plasma TV Wall Mount - LCD retractable TV mount is perfect for the kitchen and allows the LCD TV to fold up securely out of the way when not in use. The mount folds down, tilts, and swivels 180° for optimum viewing. Installs in minutes. Maximum load: 33 lb. 75mm to 100mm VESA compatible. Lifetime warranty. Wall hardware included. For LCD TVs 30" to 50".



Product No.	Mfg. No.	Description	Order Mult.	Weight	Unit Cost
224732-C	FP1000	Plasma Tv Wall Mount	0/0/1	24.912	149.99 EA

SHELVING

A V F Inc

Ceiling Speaker Mount - Compatible with most surround sound speakers. Contains 2 ball joint mounts for wall, ceiling, or cabinets. Unique patented design allows 360° swivel and tilt for perfect sound direction. Maximum weight capacity: 10 lb. All hardware included. Made from zinc for strength and durability. Silver finish.



Product No.	Mfg. No.	Description	Order Mult.	Weight	Unit Cost
224689-B	P6199SP	Ceiling Speaker Mounts	1/0/6	1.300	39.99 EA

Edsal

Heavy-Duty Storage Shelving - Super strong, sway free, sturdy steel construction with both back and side braces. Strong X back brace construction. Ribbed shelves and posts. Shelves adjust at 1-1/2" intervals. Double bolt construction with 8 bolts each shelf. Vista gray baked enamel for smooth, rust-resistant finish. Plastic floor protectors included. 500 lb. per unit. 36" x 16" x 72", 5 shelf.



Product No.	Mfg. No.	Description	Order Mult.	Weight	Unit Cost
212059-C	7216H	H/d 5-shelf Unit	0/0/1	26.000	34.99 EA

Edsal

Heavy Industrial Duty Rack - Maximum strength modular storage system. Heavy-gauge steel posts and support beams for unparalleled stability. Easily assembled with no nuts or bolts. Extra strong 1/2" particleboard shelves for maximum strength. Shelves adjust at 1-1/2" intervals. Gray baked enamel finish. 1200 lb. per unit. 36" x 18" x 72", 5 shelf unit.



Product No.	Mfg. No.	Description	Order Mult.	Weight	Unit Cost
226149-C	SR100	Industrial 5-shelf Unit	0/0/1	70.000	67.99 EA

Sensible Storage

Industrial Strength 5-Shelf Kit - Heavier gauge shelf construction makes these the shelving units of choice when heavy bearing capacity is needed. Each shelf is rated to support 800 lb. of evenly distributed static weight. More than enough strength than needed for most industrial storage applications. Maintenance-free black epoxy finish. Dimensions: 18" D. x 42" W. x 72" H.



Product No.	Mfg. No.	Description	Order Mult.	Weight	Unit Cost
208402-B	30061	Blk H/duty 5-shelf Kit	0/0/1	75.000	97.99 EA

HARDWARE



Plastic Storage Shelving - Manufactured of high-impact, chemical-resistant plastic. Rigid I-beam construction. Ideal for garage, basement, laundry, and utility areas. Easy, quick assembly, no tools required. 56-1/4" H. x 34-1/4" W. x 14-1/4" D. 4 shelf unit. Capacity per shelf: 100 lb. evenly distributed.



Product No.	Mfg. No.	Description	Order Mult.	Weight	Unit Cost
235377-C	904	Charcoal gray	0/0/1	15.000	39.99 EA
240028-C	904W	White	0/0/1	17.000	36.49 EA



Plastic Storage Shelving - Manufactured of high-impact, chemical-resistant plastic. Rigid I-beam construction. Ideal for garage, basement, laundry, and utility areas. Easy quick assembly, no tools required. Charcoal gray. 74" H. x 34-1/4" L. x 14-1/4" D. 5 shelf unit. Capacity per shelf: 100 lb. evenly distributed.



Product No.	Mfg. No.	Description	Order Mult.	Weight	Unit Cost
238996-C	905	Gray Durashelf 5 Shelf	0/0/1	19.000	56.99 EA



Plastic Vented Shelving - Industrial strength high-impact resistant plastic for heavy-duty applications. Easy, quick assembly, no tools required. Color: Gray. 56-1/4" H. x 34-1/4" W. x 14-1/4" D. 4 shelf unit. Capacity per shelf: 125 lb. per shelf evenly distributed.



Product No.	Mfg. No.	Description	Order Mult.	Weight	Unit Cost
223042-C	924	Gray 4-shelf Vented Unit	0/0/1	23.000	49.99 EA



Plastic Vented Shelving - Industrial strength, high-impact resistant plastic for heavy-duty applications. Easy, quick assembly, no tools required. Can be divided into a 3-shelf unit and 2-shelf unit. Color: Gray. 74" H. x 34-1/4" W. x 14-1/4" D. 5 shelf unit. Capacity per shelf: 125 lb. per shelf evenly distributed.



Product No.	Mfg. No.	Description	Order Mult.	Weight	Unit Cost
223034-C	925	Gray 5-shelf Vented Unit	0/0/1	29.000	59.99 EA

Your representative can give you details on product availability and shipping requirements!

HARDWARE

HyLoft USA, LLC

HyLoft Heavy-Duty Shelf - 2' x 4' heavy-duty shelves attach directly to the wall. The low profile shelves provide plenty of room below the brackets to install multiple shelves. Manufactured from durable steel with an attractive scratch-resistant white powder-coated finish that will never rust. Supports up to 200 lb. 2 shelves with hardware.



Product No.	Mfg. No.	Description	Order Mult.	Weight	Unit Cost
205977-B	00631	Heavy Duty Shelf	1/0/20	34.700	66.99 EA

HyLoft USA, LLC

Ceiling Mounted Shelf - HyLoft's unique storage system attaches to the garage rafters even through the drywall ceiling over automobiles over the open garage door itself. It adjusts to fit any garage and manufactured from durable steel with an attractive scratch-resistant white powder-coated finish that will never rust. Approximately 4' x 4', has an adjustable height from 16" to 28" and holds 250 lb.



Product No.	Mfg. No.	Description	Order Mult.	Weight	Unit Cost
205968-B	00540	Ceiling Mounted Shelf	1/0/20	34.500	67.99 EA

Knap & Vogt

Adjustable Standard - Traditional design with electro-plated finish, except white and black (model No. 80BLK24 thru 80BLK72), painted for a more contemporary look. Allows 1" shelf adjustments using model No. 180 series brackets standard measures 5/8" W. x 13/32" D. Available in anochrome (ANO), brass (BR), painted black (BLK), and painted white (WH) finish.



Product No.	Mfg. No.	Description	Order Mult.	Weight	Unit Cost
211372-C	80ANO-24	24" Anoch Shelf Standard	1/10/50	.538	2.29 EA
211390-C	80ANO-36	36" Anoch Shelf Standard	1/10/50	.840	3.29 EA
211416-C	80ANO-48	48" Anoch Shelf Standard	1/10/50	1.120	4.49 EA
211425-C	80ANO-60	60" Anoch Shelf Standard	1/10/50	1.400	5.29 EA
211434-D	80ANO-72	72" Anoch Shelf Standard	1/10/50	1.680	6.49 EA
211452-C	80BR-24	24" Brass Shelf Standard	1/10/50	.538	2.99 EA
211461-C	80BR-36	36" Brass Shelf Standard	1/10/50	.800	4.29 EA
211470-D	80BR-48	48" Brass Shelf Standard	1/10/50	1.120	5.79 EA
211498-C	80BR-72	72" Brass Shelf Standard	1/10/50	1.680	8.49 EA
211273-D	80BLK24	24" Black Shelf Standard	1/10/50	.105	2.99 EA
211265-C	80BLK36	36" Black Shelf Standard	1/10/50	.017	3.79 EA
211257-C	80BLK48	48" Black Shelf Standard	1/10/50	.205	4.99 EA
211222-C	80BLK72	72" Black Shelf Standard	1/10/50	.305	7.49 EA
217492-C	80WH	24" White Shelf Standard	1/10/50	.525	2.29 EA
217928-D	80WH	36" White Shelf Standard	1/10/50	.788	3.49 EA
218632-C	80WH	48" White Shelf Standard	1/0/10	1.120	4.49 EA
218721-C	80WH	72" White Shelf Standard	1/0/10	1.680	6.29 EA

Knap & Vogt

Boltless Bracket - Traditional design with electro-plated finish, except white and black (model No. 180BLK6 thru 180BLK12) - painted for a more contemporary look. Patented friction grip assures firm and square hold with perfect alignment of shelves. For use with model No. 80 series standards. Available in anochrome (ANO), brass (BR), painted black (BLK), and painted white (WH) finish.



Product No.	Mfg. No.	Description	Order Mult.	Weight	Unit Cost
211559-D	180ANO-6IN	6" Anochrome Bracket	1/10/100	.169	1.99 EA

Continued Next Column

SHELVING

Continued From Previous Column

Product No.	Mfg. No.	Description	Order Mult.	Weight	Unit Cost
211568-D	180ANO-8IN	8" Anochrome Bracket	1/10/100	.219	1.99 EA
211577-C	180ANO-10IN	10" Anochrome Bracket	1/10/100	.256	1.99 EA
211586-C	180ANO-12IN	12" Anochrome Bracket	1/10/100	.285	2.29 EA
211595-C	180ANO-14IN	14" Anochrome Bracket	1/10/100	.388	2.49 EA
211602-C	180ANO-16IN	16" Anochrome Bracket	1/10/50	.475	2.99 EA
211611-D	180ANO-18IN	18" Anochrome Bracket	1/10/100	.488	3.29 EA
211657-D	180BR-6IN	6" Brass Bracket	1/10/100	.163	2.29 EA
211666-C	180BR-8IN	8" Brass Bracket	1/10/100	.219	2.29 EA
211675-D	180BR-10IN	10" Brass Bracket	1/10/100	.256	2.49 EA
211684-C	180BR-12IN	12" Brass Bracket	1/10/100	.285	2.49 EA
211184-D	180BLK6	6" Black Bracket	1/10/100	.017	1.99 EA
211176-C	180BLK8	8" Black Bracket	1/10/100	.022	1.99 EA
211168-D	180BLK10	10" Black Bracket	1/10/100	.025	2.29 EA
211028-D	180BLK12	12" Black Bracket	1/10/100	.029	2.49 EA
212941-D	180WH	6" White Bracket	1/10/100	.174	1.99 EA
216322-D	180WH	8" White Bracket	1/10/100	.206	1.99 EA
216830-D	180WH	10" White Bracket	1/10/100	.250	2.29 EA
217312-D	180WH	12" White Bracket	1/10/100	.288	2.49 EA

Knap & Vogt

Shelf Supports - 3/4" L. x 5/8" W. Use with model No. 233, 255, and 255B standards.



Product No.	Mfg. No.	Description	Order Mult.	Weight	Unit Cost
211988-C	256ZC	100 supports, loose per box; zinc (ZC) finish	100/0/1000	.022	.13 EA
232233-C	256P-ZC	12 supports and 28 nails per poly-bag; zinc (ZC) finish	1/0/10	.338	2.79 BG
209333-C	256BR	100 supports, loose per box; brass (BR) finish	100/0/1000	.022	.19 EA
206057-C	256P-BR	12 supports and 28 nails per poly-bag; brass (BR) finish	1/0/10	.338	3.29 BG
201499-C	256SPWH	12 supports and 28 nails per bag; white (WH) finish	1/0/10	.284	3.79 BG

Knap & Vogt

Adjustable Shelf Standard - For surface mounting. Easily installed without grooving wood. 13/16" W. x 3/16" H. x 1/2" adjustment. Numbered every inch for shelf alignment. Zinc-plated (ZC) finish.



Product No.	Mfg. No.	Description	Order Mult.	Weight	Unit Cost
211853-D	PK233ZC	48" Zinc Shelf Standard	0/0/20	.560	2.49 EA
211862-D	PK233ZC	72" Zinc Shelf Standard	0/0/20	.840	3.79 EA

SHELF BRACKETS

HARDWARE

Knape & Vogt

Adjustable Shelf Standard - For flush or surface mounting, has flat surface and square edges. 5/8" W. x 3/16" H., 1/2" adjustment. Numbered every inch for shelf alignment. Bright zinc (ZC), brass-plated (BR), or white (WH) finishes available. Steel. 19-gauge pilasters for built-in shelving and bookcase applications.



Product No.	Mfg. No.	Description	Order Mult.	Weight	Unit Cost
205432-E	PK255ZC	36" Zinc Shelf Standard	0/0/20	.350	1.79 EA
211899-D	PK255ZC	48" Zinc Shelf Standard	0/0/20	.560	2.29 EA
211906-D	PK255ZC	60" Zinc Shelf Standard	0/0/20	.700	2.79 EA
211915-D	PK255ZC	72" Zinc Shelf Standard	0/0/20	.840	3.29 EA
205600-D	PK255BR	36" Brass Shelf Standard	0/0/20	.350	1.99 EA
205557-D	PK255BR	48" Brass Shelf Standard	0/0/20	.560	2.79 EA
205986-D	PK255BR	60" Brass Shelf Standard	0/0/20	.700	3.49 EA
206039-D	PK255BR	72" Brass Shelf Standard	0/0/20	.840	3.99 EA
201502-D	PK255WH48	48" White Shelf Standard	0/0/20	.431	2.79 EA
201510-D	PK255WH60	60" White Shelf Standard	0/0/20	.537	3.29 EA
201561-D	PK255WH72	72" White Shelf Standard	0/0/20	.644	3.99 EA

Knape & Vogt

Twin Slot Standard - Decorative, heavy-duty shelving system offers a dramatic new choice for heavy-duty applications where style and appearance are essential. The twin slotted standard has smooth contemporary design. Shelving can be used for numerous commercial, retail store fixture, custom home, business and medical office applications. Available in white. 16-1/2", 39", and 63" lengths. Use with 182 series bracket.



Product No.	Mfg. No.	Description	Order Mult.	Weight	Unit Cost
237418-D	82WH16.5	16.5" Wht Shelf Standard	1/0/10	.720	2.99 EA
237442-D	82WH39	39" White Shelf Standard	1/0/10	1.680	5.79 EA
237469-D	82WH63	63" White Shelf Standard	1/0/10	3.340	9.29 EA

Knape & Vogt

Shelf Bracket - The lock-in tab bracket provides greater strength and stability. Two 10-1/2" brackets support up to 300 lbs. Brackets designed with access holes to attach shelves to brackets for extra safety. Features screw cover tabs for a more finished look. Available in white. Available in a range of sizes: 7", 9", 10-1/2", 12-1/2", 14-1/2", and 18-1/2" lengths. Use with model No. 82 series standards.



Product No.	Mfg. No.	Description	Order Mult.	Weight	Unit Cost
237485-D	182WH7	7" White Bracket	1/0/10	.290	2.49 EA
237507-D	182WH9	9" White Bracket	1/0/10	.380	2.79 EA
237523-D	182WH10.5	10-1/2" White Bracket	1/0/10	.460	3.49 EA
237566-D	182WH12.5	12-1/2" White Bracket	1/0/10	.560	3.79 EA
237582-D	182WH14.5	14-1/2" White Bracket	1/0/10	.960	4.29 EA
237604-D	182WH18.5	18-1/2" White Bracket	1/0/10	1.190	6.79 EA

Knape & Vogt

Shelving - Solid 5/8" particle board covered with Melatex hard surface laminate, resists stains, impervious to marks and scratches. Easy-to-clean. Available in walnut, oak, and cherry. Shelving is unwrapped.



Product No.	Mfg. No.	Description	Order Mult.	Weight	Unit Cost
231145-D	1980W	8x24 Walnut Shelf	1/0/5	3.744	4.79 EA
231154-D	1980W	8x36 Walnut Shelf	1/0/5	5.616	7.29 EA
231181-D	1980W	10x36 Walnut Shelf	1/0/5	7.020	9.29 EA

Continued Next Column

Continued From Previous Column

Product No.	Mfg. No.	Description	Order Mult.	Weight	Unit Cost
231190-D	1980W	10x48 Walnut Shelf	1/0/5	9.360	12.49 EA
231519-D	1980W	12x24 Walnut Shelf	1/0/5	5.616	7.49 EA
231207-D	1980W	12x36 Walnut Shelf	1/0/5	8.424	10.79 EA
231216-D	1980W	12x48 Walnut Shelf	1/0/5	11.232	14.49 EA
205141-D	1980OK	8x24 Oak Shelf	1/0/5	3.744	4.99 EA
205168-D	1980OK	8x36 Oak Shelf	1/0/5	5.616	7.49 EA
205176-D	1980OK	8x48 Oak Shelf	1/0/5	7.488	9.79 EA
205184-D	1980OK	10x24 Oak Shelf	1/0/5	4.680	6.29 EA
205206-D	1980OK	10x36 Oak Shelf	1/0/5	7.020	9.29 EA
205214-D	1980OK	10x48 Oak Shelf	1/0/5	9.360	12.49 EA
205222-D	1980OK	12x24 Oak Shelf	1/0/5	5.616	7.49 EA
205230-D	1980OK	12x36 Oak Shelf	1/0/5	8.424	10.99 EA
205249-D	1980OK	12x48 Oak Shelf	1/0/5	11.232	14.79 EA
203343-D	1980CH	12x36 Cherry Shelf	1/0/5	8.424	10.99 EA

Knape & Vogt

Shelving - Solid shelves of 5/8" thick high-density particle board covered with hot laminated vinyl. Available in white. Standard shelves.



Product No.	Mfg. No.	Description	Order Mult.	Weight	Unit Cost
248673-D	1980WH	6x24 White Shelf	1/0/5	.560	5.29 EA
219310-D	1980WH	8x24 White Shelf	1/0/5	3.744	4.79 EA
219999-D	1980WH	8x36 White Shelf	1/0/5	5.616	7.29 EA
220273-D	1980WH	8x48 White Shelf	1/0/5	7.488	9.79 EA
220549-D	1980WH	10x24 White Shelf	1/0/5	4.680	5.99 EA
221129-D	1980WH	10x36 White Shelf	1/0/5	7.020	9.29 EA
221664-D	1980WH	10x48 White Shelf	1/0/5	9.360	12.49 EA
221904-D	1980WH	12x24 White Shelf	1/0/5	5.616	7.29 EA
222752-D	1980WH	12x36 White Shelf	1/0/5	8.424	10.79 EA
224279-D	1980WH	12x48 White Shelf	1/0/5	11.232	14.49 EA



5' Spacemaker Closet System - Extra strong shelf and rod shelving, constructed from heavy-gauge steel with durable epoxy finish. For closets 5' wide and under. System includes 3 shelves, single pole and necessary mounting hardware. Triple the use of closet space with an elegant contemporary look.



Product No.	Mfg. No.	Description	Order Mult.	Weight	Unit Cost
213624-C	4015120511	5 Closet System	0/0/1	12.000	44.49 EA

HARDWARE

We will gladly special order any items you require, and we can ship most non-stocked items next day!

HARDWARE



8' Spacemaker Closet System - Extra strong shelf and rod shelving, constructed from heavy-gauge steel with durable epoxy finish. For closets 8' wide and under. System includes 5 shelves, 2 poles and necessary mounting hardware. Triple the use of closet space with an elegant contemporary look.



Product No.	Mfg. No.	Description	Order Mult.	Weight	Unit Cost
213632-D	4015120811	8' Closet System	0/0/1	21.000	82.99 EA



12" Linen Shelf - 6-pieces per carton. Constructed of welded steel rods and coated with a durable bright white epoxy finish. Linen shelf measures 12" D. x 12' L.

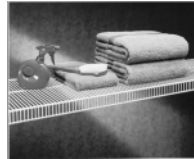

Product No.	Mfg. No.	Description	Order Mult.	Weight	Unit Cost
217786-E	1210121211	12" Linen Shelf	0/0/6	15.000	28.49 EA



16" Linen Shelf - 6-pieces per carton. Constructed of welded steel rods and coated with a durable bright white epoxy finish. Linen shelf measures 16" D. x 12' L.

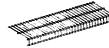

Product No.	Mfg. No.	Description	Order Mult.	Weight	Unit Cost
217794-D	1210161211	16" Linen Shelf	0/0/6	16.667	35.99 EA



20" Linen Shelf - 6-pieces per carton. Constructed of welded steel rods and coated with a durable bright white epoxy finish. Linen shelf measures 20" D. x 12' L.



Product No.	Mfg. No.	Description	Order Mult.	Weight	Unit Cost
237884-D	1210201211	20" Linen Shelf	0/0/6	21.333	44.99 EA



Tight Mesh Linen Shelf - 6-pieces per carton. Tight mesh design keeps the smallest items upright. Constructed of welded steel rods and coated with a durable bright white epoxy finish.



Product No.	Mfg. No.	Description	Order Mult.	Weight	Unit Cost
253383-D	1510121211	12" D. x 12' W.	0/0/6	17.400	37.99 EA
242667-D	1510161211	16" D. x 12' W.	0/0/6	19.783	47.49 EA

WIRE SHELVING



12" Shelf And Rod - 6-pieces per carton. Constructed of welded steel rods and coated with a durable bright white epoxy finish. Shelf and rod measures 12" D. x 12' L. with a clothes hanger rod which eliminates the need for a separate closet pole.



Product No.	Mfg. No.	Description	Order Mult.	Weight	Unit Cost
217808-B	1110121211	12" Shelf/rod	0/0/6	15.833	21.99 EA



16" Shelf And Rod - 6-pieces per carton. Constructed of welded steel rods and coated with a durable bright white epoxy finish. Shelf and rod measures 16" D. x 12' L. with a clothes hanger rod which eliminates the need for a separate closet pole.

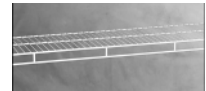

Product No.	Mfg. No.	Description	Order Mult.	Weight	Unit Cost
217816-D	1110161211	16" Shelf/rod	0/0/6	19.167	39.49 EA



Open Slide II™ Shelf - Heavy-gauge steel and baked on epoxy coating actually bonds to the steel to produce a tough, hardened finish that will not crack, discolor, or become sticky. Open Slide II™ is a continuous slide design that allows uninterrupted hanger movement the entire width of the shelf.



Product No.	Mfg. No.	Description	Order Mult.	Weight	Unit Cost
217883-D	1710121211	12" D. x 12' W.	0/0/6	18.833	52.99 EA
217875-D	1710161211	16" D. x 12' W.	0/0/4	22.500	64.99 EA



Shelving With Hanging Rod - Heavy-gauge steel and baked-on epoxy finish assures strength and durability. Shelving with hanging rod does double duty with a shelf for storage and a rod for clothes hangers. Hardware sold separately. Color: White.

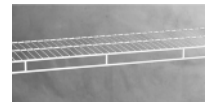

Product No.	Mfg. No.	Description	Order Mult.	Weight	Unit Cost
217832-D	1111124811	12" D. x 4' W.	1/0/6	5.167	16.49 EA
217824-D	1111127211	12" D. x 6' W.	1/0/6	7.833	23.49 EA

WIRE SHELVING



Linen And Storage Shelf - Heavy-gauge steel with a baked-on epoxy finish assures strength and durability. Storage shelf takes on the tough loads everywhere from the kitchen, pantry, and play room to the workshop, garage, and office. Upside down, it converts to a shoe rack with added shoe rack supports. Hardware sold separately. Color: White.



Product No.	Mfg. No.	Description	Order Mult.	Weight	Unit Cost
217751-D	1211124811	12" D. x 4' W.	1/0/6	5.000	13.79 EA
217743-D	1211127211	12" D. x 6' W.	1/0/6	7.500	19.99 EA



Linen And Storage Shelf - 16" storage shelf. Heavy-gauge steel with a baked-on epoxy finish assures strength and durability. 16" D. x 6' W. Color: White. Hardware sold separately.



Product No.	Mfg. No.	Description	Order Mult.	Weight	Unit Cost
217735-D	1211167211	16x72 Linen Shelf	1/0/6	8.333	23.99 EA



Versa-Clip With Tri-Loc® Anchor - Attaches back of shelving to wall. Strongest back clip in the industry. Universal as a clip and a down back clip. Install into hollow walls or any substrate.

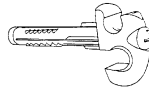

Product No.	Mfg. No.	Description	Order Mult.	Weight	Unit Cost
219622-D	1464662011	10-pieces per bag	1/0/50	.190	4.29 BG
219665-D	1466662011	100-pieces per bag	1/0/5	1.880	41.49 BG



Versa-Clip With Tri-Loc® II Anchor - Attaches back of shelving to wall. Strongest back clip in the industry. Universal as a back clip and a down back clip. Installs into hollow walls or any substrate. 7-pieces per package.

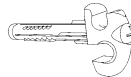

Product No.	Mfg. No.	Description	Order Mult.	Weight	Unit Cost
217700-D	1412662011	Versa-clip W/anchor	1/0/12	.173	5.29 CD



Tri-Loc® II Anchor - Used to attach support brace to drywall. Preassembled with screw for 1/4" hole in drywall. 10-pieces per bag.



Product No.	Mfg. No.	Description	Order Mult.	Weight	Unit Cost
219681-D	1464662311	10pk Tri-loc Anchor	1/0/25	.154	3.29 BG

HARDWARE



Melamine Shelf - 5/8" melamine shelf for use with solid shelf bracket. Radius edge band on 3 sides, coordinates with O-boxes. Use with brackets model No. 7913141311. Part of Freedom Rail system.



Product No.	Mfg. No.	Description	Order Mult.	Weight	Unit Cost
208714-D	7313142411	14" D. x 2' W., white	1/0/4	6.463	13.49 EA
208723-D	7313143611	14" D. x 3' W., white	1/0/4	9.465	18.49 EA
208750-D	7313144811	14" D. x 4' W., white	1/0/4	13.220	22.49 EA
208769-D	7313147211	14" D. x 6' W., white	1/0/2	19.800	32.99 EA



Sidewall Bracket With Tri-Loc® II Anchor - Attaches to side wall. Supports front end of shelf. Preassembled for 1/4" hole in drywall. Includes screws and anchors.



Product No.	Mfg. No.	Description	Order Mult.	Weight	Unit Cost
219630-D	1464662111	2 per bag	1/0/30	.154	3.49 BG
219657-D	1466662111	30 per bag	1/0/2	2.345	49.49 BG



Freedom Rail Twin Shelf Bracket - Epoxy-coated heavy-gauge steel. Ventilated shelf brackets for use with multiple shelving pieces listed below. Color: White.



Product No.	Mfg. No.	Description	Order Mult.	Weight	Unit Cost
248576-D	7913141211	For use with 12" profile shelf; 12" and 16" shelf with hanging rod, 12" and 16" open slide II, 12" tight mesh and 12" linen and storage shelving	1/0/10	.620	3.99 EA
248584-C	7913141611	For use with 16" profile shelf; 16" tight mesh, 16" linen, and storage shelves	1/10/50	1.150	5.49 EA

HARDWARE



Support Brace - Hooks to shelf, pulls down to locked position. Provides intermediate and/or end support. Used with 12" standard and tight mesh storage shelves, 12" and 16" shelf with hanging rod, and 12" or 16" Open Slide II. Recommended for support every 3'6" span.



Product No.	Mfg. No.	Description	Order Mult.	Weight	Unit Cost
227366-D	1412665911	2 per card	1/0/12	.683	7.49 PR
230278-D	1464665911	100 per bulk box	1/0/100	.333	2.29 EA



Support Brace - Hooks to shelf, pulls down to locked position. Provides intermediate and/or end support. Used with 16" standard and tight mesh storage shelves and as a center support for 20" tight mesh storage shelf. Recommended for support every 3'6" span.



Product No.	Mfg. No.	Description	Order Mult.	Weight	Unit Cost
217689-D	1412666111	2 per bag	1/0/12	.833	9.29 BG
230286-D	1464666111	40 per bulk box	1/0/40	.278	2.49 EA



Support Brace - Hooks to shelf, pulls down to locked position. Provides intermediate and/or end support. Used with 20" storage/linen shelf or standard and tight mesh storage shelves.

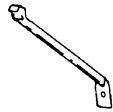

Product No.	Mfg. No.	Description	Order Mult.	Weight	Unit Cost
237892-D	1465666311	20" Support Brace	1/0/30	.390	2.49 EA



Open Slide II End Bracket - Attaches to side walls. Supports front of shelf from sidewalls. The bracket comes complete with Tri-Loc® II anchors. Consumer retail package. 2 per bag.

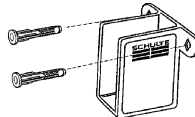

Product No.	Mfg. No.	Description	Order Mult.	Weight	Unit Cost
217719-D	1412662111	Open Slide End Bracket	1/0/12	.189	3.99 CD

WIRE SHELVING



Adjustable Pole Clips And Caps - Used with vertical support pole. Clips are used to attach shelf to support pole. Base caps are used to protect floor. 5 clips and 2 caps per bag.



Product No.	Mfg. No.	Description	Order Mult.	Weight	Unit Cost
230332-D	1464666511	Pole Clips & Cap	1/0/25	.100	4.79 BG



Vertical Support Pole - For use on open-end installation, or as a center support. Use with base cap and adjustable pole clip. Measures 84".



Product No.	Mfg. No.	Description	Order Mult.	Weight	Unit Cost
217905-D	1465667311	84" Vert Support Pole	0/0/12	.792	7.99 EA



Freedom Rail Shelf Locator - Shelf locators form a secure connection between the wood shelf bracket and melamine or glass shelving. No tools required. Shelf undersides are not defaced. Locators can be removed if adjusting shelves. For single shelf or 2 shelves. Will work with glass shelving. Contents: 12 clear acrylic shelf tabs with pre-applied double sided tape. 6 No. 6 Phillips screws.

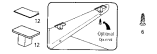

Product No.	Mfg. No.	Description	Order Mult.	Weight	Unit Cost
202177-D	7913915840	Shelf Locator	1/0/12	.208	4.99 CD



Freedom Rail End Cap - Profile end caps, for use with profile shelving. Enough end caps per card for 3 shelves. 6 double, 12 small, and 6 large. Color: White.

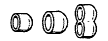

Product No.	Mfg. No.	Description	Order Mult.	Weight	Unit Cost
201626-D	7913660011	White End Caps	1/0/12	.292	2.79 CD



Freedom Rail Rod Clip - The rod clip supports the chrome rod under the ventilated shelf bracket. Its unique design provides uninterrupted sliding of hangers along the chrome rod. Snaps into place and stays secure. Color: Chrome finish.



Product No.	Mfg. No.	Description	Order Mult.	Weight	Unit Cost
201553-D	7913150034	Chrome Rod Clip	1/0/12	.292	2.49 EA

CLOSET RODS



Rod Stop - Insert into both ends of the chrome rod. With the open-slide feature, you will always want to provide a rod stop to prevent hangers from falling off. Chrome closet rods. Snaps into place. Color: Chrome. 1 pair per bag.



Product No.	Mfg. No.	Description	Order Mult.	Weight	Unit Cost
201383-D	7913151034	Chrome Rod Stops	1/0/12	.209	3.79 BG



Freedom Rail Chrome Rod - Chrome rods are securely attached to the rod clip for uninterrupted hanging space. Chrome rods are available in the same sizes as the profile shelf for easy specification and quick installation. Purchase rod stops separately to complete the job. Cut to size with hacksaw blade for exact size.



Product No.	Mfg. No.	Description	Order Mult.	Weight	Unit Cost
200301-D	7913152434	2'	1/0/8	1.000	4.29 EA
219392-D	7913153634	3'	1/0/8	1.425	6.29 EA
200603-D	7913154834	4'	1/0/8	2.000	8.29 EA
201882-D	7913157234	6'	1/0/8	3.000	12.49 EA
200794-D	7913159634	8'	1/0/8	4.000	16.49 EA

Sterling Corp., John

Do it® Closet Rod - Adjustable to fit any closet. End flanges simplify installation to hook rail. Screws included. Lustra finish. Features blister package header for retail display.



Product No.	Mfg. No.	Description	Order Mult.	Weight	Unit Cost
226400-D	226400	Extends 18" to 30"	1/0/10	1.100	3.39 EA
226464-D	226464	Extends 30" to 48"	1/0/10	1.500	4.49 EA
226473-D	226473	Extends 48" to 72"	1/0/10	2.500	6.39 EA
226482-D	226482	Extends 72" to 96"	1/0/10	3.300	7.99 EA
226525-D	226525	Extends 72" to 120"	1/0/10	3.600	9.79 EA
226936-D	226936	Extends 96" to 144"	1/0/10	5.300	11.79 EA

National Mfg.

Pole Socket - Steel sockets for mounting wood closet poles up to 1-3/8" in diameter. Satin brass finish. Screws included.



Product No.	Mfg. No.	Description	Order Mult.	Weight	Unit Cost
242136-D	N191551	1-3/8" Satin Brs Socket	1/10/50	.208	1.49 PK

National Mfg.

Pole Socket Set - For wooden clothes poles up to 1-3/8" diameter. Single screw mounting. White styrene. Available in visual pack or stock pack. Includes screws. 1 set per visual or stock pack.



Product No.	Mfg. No.	Description	Order Mult.	Weight	Unit Cost
234838-D	N154567	1-3/8" Wht Pole Socket	1/8/48	.080	1.29 PK
234847-D	N154559	1-3/8" Wht Pole Socket	1/0/15	.080	.79 PK

HARDWARE

Sterling Corp., John

Closet Pole Socket - Steel sockets for poles up to 1-3/8" diameter. Brass-plated. 2 per card. Screws included.

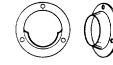

Product No.	Mfg. No.	Description	Order Mult.	Weight	Unit Cost
218008-D	BC-0039-3	2pk Brass Pole Socket	1/0/10	.004	1.99 CD

Sterling Corp., John

Pole Socket - Molded white plastic sockets for poles 1-1/4" diameter. 2 per card.



Product No.	Mfg. No.	Description	Order Mult.	Weight	Unit Cost
215155-E	BC-0037	2pk Wht Pole Socket	1/0/10	.133	1.29 CD

Sterling Corp., John

Closet Rod - Extra heavy-duty adjustable closet rods. 1-1/4" diameter, steel tube. 22-gauge. Durable, scratch-resistant white powder-coat finish. Easy slide finish.



Product No.	Mfg. No.	Description	Order Mult.	Weight	Unit Cost
214914-D	RP-0021-30/48	30" to 48"	1/0/10	1.100	9.79 EA
214930-D	RP-0021-48/72	48" to 72"	1/0/10	2.500	12.99 EA
214949-D	RP-0021-72/120	72" to 120"	1/0/10	3.600	19.79 EA

Sterling Corp., John

Closet Pole - Extra heavy-duty cut-to-length poles. Large 1-1/4" diameter, steel tube. 22-gauge. Durable, scratch-resistant white powder-coat finish. Easy slide finish. Cut-to-length poles in 3 sizes: 4', 6', and 8'.



Product No.	Mfg. No.	Description	Order Mult.	Weight	Unit Cost
215074-D	0018-4	4' x 1-1/4" diameter	1/0/8	1.750	7.99 EA
215112-D	0018-6	6' x 1-1/4" diameter	1/0/8	2.500	10.99 EA
215287-D	0018-8	8' x 1-1/4" diameter	1/0/8	3.250	13.49 EA

Sterling Corp., John

Shelf Bracket - Heavy-duty shelf bracket (12-gauge) thick steel. 10". White. Less screws.

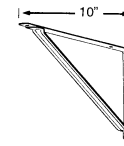

Product No.	Mfg. No.	Description	Order Mult.	Weight	Unit Cost
214906-D	RP-0046-WT	White Shelf Bracket	1/0/20	1.000	2.49 EA

HARDWARE

CLOSET RODS

Sterling Corp., John

Shelf Bracket - Heavy-duty shelf and rod bracket. (12-gauge) thick steel. 10-3/4". White. Less screws.



Product No.	Mfg. No.	Description	Order Mult.	Weight	Unit Cost
214892-C	RP-0045-WT	White Shelf/rod Bracket	1/0/20	1.000	2.39 EA

Sterling Corp., John

Shelf Bracket - Shelf and rod bracket of wrought steel, embossed for extra strength (16-gauge). Pole bracket takes 1-3/8" rod, snaps into place. Supports shelves to 12" wide, bracket depth is 11". Screws are not included. White. With UPC stickers.



Product No.	Mfg. No.	Description	Order Mult.	Weight	Unit Cost
211256-D	RP-0044-BWT	White Shelf/rod Bracket	1/0/20	.800	1.99 EA

Waddell

Pole Socket - Made of hard Maple for maximum strength. Use as supporting pole for hanging clothes in closets, wardrobes, etc. Extra deep holes to prevent heavily loaded poles from dropping out. 1 socket is slotted so the pole can be easily put in or be removed. Packed 1 set in plastic bag with screws.

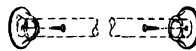

Product No.	Mfg. No.	Description	Order Mult.	Weight	Unit Cost
208655-D	410DI	1-3/8" Do it™ brand	1/0/15	.133	1.99 BG
253766-D	415D	1-3/4" Waddell brand	1/0/15	.014	3.99 BG

Lido Designs

Closet Rod - 1-5/16" closet rod. The strongest rod available for all your closet needs. This heavy-duty steel closet rod comes in 6' and 8' lengths.



Product No.	Mfg. No.	Description	Order Mult.	Weight	Unit Cost
257273-C	LB-10-A106/6	6', chrome	1/0/6	6.113	25.49 EA
257265-C	LB-10-A106/8	8', chrome	1/0/6	8.194	34.49 EA
207671-C	LB-26-A106/6	6', white	1/0/6	12.208	15.49 EA
207680-C	LB-26-A106/8	8', white	1/0/6	12.208	21.49 EA
219659-C	LB-44-A106/6	6', brushed stainless steel	1/0/6	1.000	31.99 EA
219668-C	LB-44-A106/8	8', brushed stainless steel	1/0/6	1.000	41.49 EA

Lido Designs

Extend and Lock Closet Rods - Extendable rods fit all closets. High grade rust proof steel. Concealed wall attachments. Easy to install. No cutting required. Mounting hardware included.



Product No.	Mfg. No.	Description	Order Mult.	Weight	Unit Cost
222663-C	LB-26-E103/2030	White, 20" to 30"	1/0/6	1.667	6.79 EA

Continued Next Column

Continued From Previous Column

Product No.	Mfg. No.	Description	Order Mult.	Weight	Unit Cost
222627-D	LB-26-E103/3048	White, 30" to 48"	1/0/6	2.000	8.29 EA
222636-D	LB-26-E103/4872	White, 48" to 72"	1/0/6	2.667	11.49 EA
222654-D	LB-26-E103/72120	White, 72" to 120"	1/0/6	3.833	15.49 EA
222672-D	LB-44-E103/2030	Stainless steel, 20" to 30"	1/0/6	1.667	8.79 EA
222618-D	LB-44-E103/3048	Stainless steel, 30" to 40"	1/0/6	2.000	11.49 EA
222645-D	LB-44-E103/4872	Stainless steel, 48" to 72"	1/0/6	2.667	13.99 EA
222658-B	LB-44-E103/72120	Stainless steel, 72" to 120"	1/0/6	3.833	16.49 EA

Lido Designs

Shelf And Hang Rod Bracket - Heavy-duty steel closet rod and shelf support. Supports closet rods up to 1-1/2" in diameter, and shelves up to 12" in depth.



Product No.	Mfg. No.	Description	Order Mult.	Weight	Unit Cost
257281-C	LB-10-8150	Chrome	1/0/8	.721	9.49 EA
207699-C	LB-26-8150A	White	1/0/8	1.500	4.79 EA
212687-C	LB-14-8150A	Satin nickel	1/0/8	1.375	9.49 EA

Lido Designs

Closet Rod Flange Set - Highest quality, chrome-plated zinc closet rod flange sets. The strongest pole supports in the industry. The flanges have the deepest pole sockets and provide the strongest and safest rod support. Works with closet poles up to 1-5/16" in diameter.



Product No.	Mfg. No.	Description	Order Mult.	Weight	Unit Cost
257303-C	LB-10-505SET	Chrome	1/12/48	.458	5.79 EA
257494-C	LB-26-505SET	White	1/12/48	.458	4.79 EA
213138-C	LB-14-505SET	Satin nickel	1/0/12	.500	5.79 EA

Thermwell Prods. Co.

A/C Safe® Air Conditioner Window Supports - Air conditioner supports transfer the weight of the air conditioner from the window sash and sill to the support and window frame. Constructed for long service life, made of epoxy-coated steel with stainless steel hardware, nylon fixtures, and neoprene rubber mounting pads. Air conditioner supports ensure a more secure installation with minimal chance of damage to the window, window parts, or outside wall. Fits wall thickness 4" to 11". Easy indoor installation eliminates all exterior work. 2 year limited warranty. White.



Product No.	Mfg. No.	Description	Order Mult.	Weight	Unit Cost
274968-C	ACB80H	Light-duty, load rated to 80 lb., use with most 5000 to 10,000 BTU units	1/0/6	2.500	38.99 EA
274976-C	ACB160H	Heavy-duty, load rated to 160 lb., use with most 12,000 to 24,000 BTU units	1/0/6	3.167	49.99 EA

CLOSET PARTS

Ebco Tools

Folding Table Legs - Strong 1" steel tubular legs; tightly welded joints; protective plastic tips. Create tables from discarded doors, boards, etc. Folds flat. Complete with hardware; locking device of heavy-gauge steel. Height 29". Set of 2. Gloss black finish.



Product No.	Mfg. No.	Description	Order Mult.	Weight	Unit Cost
208028-D	APF-B	29"blk Folding Table Leg	0/0/1	11.000	32.99 SET

Ardor Mfg.

Folding Leg Brackets - Made of heavy-gauge metal. Spring-action locking. Locks open or closed. Leg fits flush to table for added support. Packed 4 per set. Cadmium finish. Size: 3" x 3" x 2".

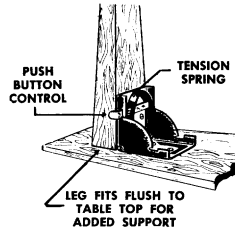

Product No.	Mfg. No.	Description	Order Mult.	Weight	Unit Cost
224484-D	BP-400	Folding Leg Bracket	1/0/12	1.604	15.79 SET

National Mfg.

Chair And Corner Brace - For bracing tables, chairs, and church pews. 1" x 1" x 3/4" W. V-pac of 4. Screws included.



Product No.	Mfg. No.	Description	Order Mult.	Weight	Unit Cost
201677-D	N176347	Antique bronze	1/5/40	.176	2.29 PK

Liberty Hardware Mfg

Bumper - 4 per card, 10 cards per box.



Product No.	Mfg. No.	Description	Order Mult.	Weight	Unit Cost
223109-D	430XC	1/2" plastic, brown	1/0/10	.040	.79 CD
223092-D	432XC	3/4" plastic, brown	1/0/10	.050	.89 CD
223083-D	434XC	7/8" plastic, brown	1/0/10	.070	.89 CD
222958-D	436XC	1/2" rubber, gray	1/0/10	.040	.69 CD
222887-D	438XC	5/8" rubber, gray	1/0/10	.050	.89 CD
222878-D	439XC	3/4" rubber, gray	1/0/10	.050	.89 CD

HARDWARE

Liberty Hardware Mfg

Tack Bumper - 4 per card, 10 cards per box. Black.



Product No.	Mfg. No.	Description	Order Mult.	Weight	Unit Cost
222869-D	440XC	3/8"	1/0/10	.040	.79 CD
222743-D	442XC	5/8"	1/0/10	.040	.89 CD

Liberty Hardware Mfg

Self-Adhesive Bumper - 4 per card, 10 cards per box. Brown.



Product No.	Mfg. No.	Description	Order Mult.	Weight	Unit Cost
222734-D	444XC	1/2"	1/0/10	.040	.99 CD
222725-D	446XC	3/4"	1/0/10	.060	1.29 CD

Liberty Hardware Mfg

Self-Adhesive Bumper - 5/16" diameter. 12 per card. 10 cards per box. Clear.



Product No.	Mfg. No.	Description	Order Mult.	Weight	Unit Cost
219193-E	429XC	12pk 5/16" Adhesv Bumper	1/0/10	.036	1.79 CD

Liberty Hardware Mfg

Felt Pad - 8 per card, 10 cards per box. Brown.

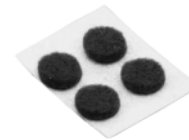

Product No.	Mfg. No.	Description	Order Mult.	Weight	Unit Cost
222716-D	448XC	3/8"	1/0/10	.030	.69 CD
222333-D	450XC	1/2"	1/0/10	.030	.79 CD

Liberty Hardware Mfg

Self-Adhesive Cork Pad - 1/8" x 1/2". 9 per card. 10 cards per box.



Product No.	Mfg. No.	Description	Order Mult.	Weight	Unit Cost
219185-D	452XC	1/8x1/2 Adhesve Cork Pad	1/0/10	.036	.99 CD

Some products shown may need to be special ordered for your convenience!

Liberty Hardware Mfg

Self-Adhesive Velvet Sheet - 3" x 3-3/4". 1 per card. 10 cards per box. Green.



Product No.	Mfg. No.	Description	Order Mult.	Weight	Unit Cost
219177-D	454XC	3x3-3/4 Grn Velvet Sheet	1/0/10	.046	.99 CD

Magic Sliders

20mm and 25mm Magic Sliders - As seen on TV. Moves everything as if it had wheels. Move up to 1600 lb. Won't scratch your floors. Works on any kind of surface: Wood floors, vinyl, ceramic tile, and carpeting. Ideal for small-footed furniture or accessories, such as chairs, TVs, stereos, speakers, microwaves, computers, coffee tables, plants, and lamps. Will slide over doorsteps or floor edges with a height difference of up to 3/16". Color: Grey. Contents: 8 per card.



Product No.	Mfg. No.	Description	Order Mult.	Weight	Unit Cost
201196-B	08200	20mm (3/4" diameter) round, with screws	1/0/10	1.270	7.79 EA
201098-B	08025	25mm (1" diameter) round, screws not included	1/0/10	1.025	6.79 EA

Magic Sliders

22mm Magic Sliders - As seen on TV. 22mm disc with nail (7/8" diameter). Moves everything as if it had wheels. Move up to 1600 lb. Won't scratch your floors. Works on any kind of surface: Wood floors, vinyl, ceramic tile, and carpeting. Ideal for moving all small wood-leg furniture: Chairs, coffee tables, lamp tables, dressers and stools. Will slide over doorsteps or floor edges with a height difference of up to 3/16". Color: Grey. Contents 8 per card.



Product No.	Mfg. No.	Description	Order Mult.	Weight	Unit Cost
201114-B	08221	22mm Rnd Magic Slider	1/0/10	1.025	7.79 EA

Magic Sliders

22mm to 25mm and 27mm to 32mm Grip Tip Magic Sliders - As seen on TV. Moves everything as if it had wheels. Move up to 1600 lb. Won't scratch your floors. Works on any kind of surface: Wood floors, vinyl, ceramic tile, and carpeting. Ideal to move stools, chairs, folding chairs, and tables. Will slide over doorsteps or floor edges with a height difference of up to 3/16". Grip tips stretch to grip a range of popular leg diameters. No adhesive required. Color: Grey. Contents: 4 grip tips per card. For round furniture legs.



Product No.	Mfg. No.	Description	Order Mult.	Weight	Unit Cost
201203-C	04225	22 to 25mm round grip tip (7/8" x 1")	1/0/10	.820	4.49 EA
201132-B	04273	27 to 32mm round grip tip (1-1/8" x 1-1/4")	1/0/10	.920	5.49 EA

Magic Sliders

50mm Magic Sliders - As seen on TV. 50mm disc (2" diameter) moves everything as if it had wheels. Move up to 2500 lb. Won't scratch your floors. Works on any kind of surface: Wood floors, vinyl, ceramic tile, and carpeting. For all appliances and footed furniture. Ideal to move refrigerators, sofas, tables, stoves, beds, dressers, washers, and dryers. Will slide over doorsteps or floor edges with a height difference of up to 3/16". Can be used over and over or attached permanently with the double-face tape provided (or epoxy or Crazy Glue Gel). Color: Grey. Contents: 4 sliding discs with adhesive.



Product No.	Mfg. No.	Description	Order Mult.	Weight	Unit Cost
201141-B	04050	50mm Rnd Magic Slider	1/0/10	1.620	6.79 EA

Magic Sliders

60mm Magic Sliders - As seen on TV. 60mm disc (2-3/8" diameter) moves everything as if it had wheels. Move up to 2500 lb. Won't scratch your floors. Works on any kind of surface: Wood floors, vinyl, ceramic tile, and carpeting. Ideal to move entertainment centers, bookcases, filing cabinets, armoires, desks, wall units, and sideboards. Will slide over doorsteps or floor edges with a height difference of up to 3/16". Can be used over and over or attached permanently with the double-face tape provided (or epoxy or Crazy Glue Gel). Color: Grey. Contents: 4 sliding discs with adhesive. For all solid based furniture.



Product No.	Mfg. No.	Description	Order Mult.	Weight	Unit Cost
201150-B	04060	60mm Rnd Magic Slider	1/0/10	2.120	7.79 EA

Magic Sliders

Magic Sliders - As seen on TV. Moves everything as if it had wheels. Move up to 3200 lb. Won't scratch your floors. Works on any kind of surface: Wood floors, vinyl, ceramic tile, and carpeting. Ideal to move armoires, desks, filing cabinets, wall units, sideboards, bookcases, and entertainment centers. Will slide over doorsteps or floor edges with a height difference of up to 3/16". No adhesive required. Color: Grey.



Product No.	Mfg. No.	Description	Order Mult.	Weight	Unit Cost
201187-B	04124	24 x 100mm (15/16" x 4") rectangle with screw, 4 per card	1/0/10	1.770	7.79 EA

Magic Sliders

100mm Magic Sliders - As seen on TV. 100mm disc (4" diameter) moves everything as if it had wheels. Move up to 3200 lb. Won't scratch your floors. Works on any kind of surface: Wood floors, vinyl, ceramic tile, and carpeting. Move any heavy furniture or appliance and then remove and reuse. Will slide over doorsteps or floor edges with a height difference of up to 3/16". Color: Grey. Contents: 4 reuseable sliding discs.



Product No.	Mfg. No.	Description	Order Mult.	Weight	Unit Cost
201212-D	04100	100mm Rnd Magic Slider	1/0/3	1.833	31.49 EA

SLIDERS

Magic Sliders

Concave Round Magic Sliders - As seen on TV. 60mm (2-3/8" diameter) concave round. Moves everything as if it had wheels. Move up to 2500 lb. Won't scratch your floors. Works on any kind of surface: Wood floors, vinyl, ceramic tile, and carpeting. Ideal for casters or nonpermanent applications on footed furniture. For moving: Sofas, refrigerators, beds, tables, dressers, washers, dryers, and stoves. Will slide over doorsteps or floor edges with a height difference of up to 3/16". Color: Grey. Contents: 4 per card.



Product No.	Mfg. No.	Description	Order Mult.	Weight	Unit Cost
201221-B	04600	60mm Concave Magic Slide	1/0/5	3.190	9.99 EA

Faultless Caster

Do it® Square Sliding Caster - Super Slidex, the sliding casters. Move everything as if on wheels. Sliding pads provide maximum mobility on any floor surface while keeping a low over all height for stability. Square. Brown. 4 per card.



Product No.	Mfg. No.	Description	Order Mult.	Weight	Unit Cost
253332-D	23137	1-3/8"	1/0/5	.190	5.99 EA
253340-D	23138	2-1/8"	1/0/5	.418	6.29 EA

Faultless Caster

Dual Wheel Stem Caster - Independent wheel rotation adds mobility on any floor surface. Nylon wheels in textured black. Full nylon hood. 2", 2-1/2" overall height. 90 lb. load capacity. 29/64" x 1-9/16" bore dimension. Stem size: 7/16" diameter x 1" L. Bulk pack. Cross Reference: Model No. 32230 PBIT335T-50SST, 32228 PBIT332-50BLK, 32226 PBIT334-50BRA, 32243 PBITW32-50BLK, 32244 PBITY32-50BLK, 32231 PBIT93ST-50SST, 32229 PBIT932-50BLK, 32227 PBIT934-50BRA, 32086 PBIT 932-40BLK, and 32087 PBIT 332-40BLK.



Product No.	Mfg. No.	Description	Order Mult.	Weight	Unit Cost
243639-D	23910	2" Dual Wheel Caster	1/0/100	.220	3.29 EA

Faultless Caster

Dual Wheel Threaded Stem Caster - Independent wheel rotation adds mobility on any floor surface. Nylon wheels in textured black. Full nylon hood. 2", 2-1/2" overall height. 90 lb. load capacity. 5/16"-18-1" stem. Bulk pack. Cross Reference: Model No. 32230 PBIT335T-50SST, 32228 PBIT332-50BLK, 32226 PBIT334-50BRA, 32243 PBITW32-50BLK, 32244 PBITY32-50BLK, 32231 PBIT93ST-50SST, 32229 PBIT932-50BLK, 32227 PBIT934-50BRA, 32086 PBIT932-40BLK, and 32087 PBIT332-40BLK.



Product No.	Mfg. No.	Description	Order Mult.	Weight	Unit Cost
243604-D	23911	2" Dual Wheel Caster	1/0/100	.240	3.29 EA

HARDWARE

Faultless Caster

Swivel Caster - Heavy-duty for general use in factories, stores, warehouses, farms, etc. Rubberex heavy-duty wheel.



Product No.	Mfg. No.	Description	Order Mult.	Weight	Unit Cost
216714-D	23714	2", 2-1/2" overall height, 90 lb. load capacity, 1-11/16" swivel radius, 15/16" x 2-1/8" hole spacing, 1-7/8" x 2-9/16" top plate	1/0/50	.480	3.99 EA
203033-D	23716	2", 2-1/2" overall height, 90 lb. load capacity, 1-11/16" swivel radius, 15/16" x 2-1/2" hole spacing, 1-7/8" x 2-9/16" top plate, side brake	1/0/50	.520	6.49 EA
216901-D	23718	2-1/2", 3-1/4" overall height, 100 lb. load capacity, 2-1/4" swivel radius, 1-3/4" x 3" hole spacing, 2-3/4" x 3-13/16" plate size	1/0/50	1.120	8.29 EA
225002-D	23719	2-1/2", 3-1/4" overall height, 100 lb. load capacity, 2-1/4" swivel radius, 1-3/4" x 3" hole spacing, 2-3/4" x 3-13/16" plate size, side brake	1/0/25	.590	10.79 EA
225241-D	23720	3", 3-13/16" overall height, 175 lb. load capacity, 2-3/8" swivel radius, 2-3/8" x 3-3/8" hole spacing, 3-1/8" x 4-1/8" plate size	1/0/25	1.520	9.29 EA
202851-D	23722	3", 3-13/16" overall height, 175 lb. load capacity, 2-3/8" swivel radius, 2-3/8" x 3-3/8" hole spacing, 3-1/8" x 4-1/8" plate size, side brake	1/0/25	1.480	11.79 EA
206105-D	23736	4", 5" overall height, 200 lb. load capacity, 3-7/16" swivel radius, 1-3/4" x 2-15/16" hole spacing, 2-1/2" x 3-5/8" plate size	1/0/20	2.250	12.99 EA
206113-D	23738	4" 5" overall height, 200 lb. load capacity, 3-7/16" swivel radius, 1-3/4" x 2-15/16" hole spacing, 2-1/2" x 3-5/8" plate size, side brake	1/0/20	2.400	21.99 EA
206121-D	23740	5", 6-1/8" overall height, 200 lb. load capacity, 3-15/16" swivel radius, 1-3/4" x 2-15/16" to 3-5/8" hole spacing, 2-1/2" x 3-5/8" plate size	1/0/10	2.800	15.99 EA
206148-D	23742	5", 6-1/8" overall height, 240 lb. load capacity, 3-15/16" swivel radius, 1-3/4" x 2" to 2-15/16" hole spacing, 2-1/2" x 3-5/8" plate size, side brake	1/0/10	2.900	23.49 EA

HARDWARE

Faultless Caster

Swivel Caster - Heavy-duty for general use in factories, stores, warehouses, farms, etc. Polyflex wheel.



Product No.	Mfg. No.	Description	Order Mult.	Weight	Unit Cost
239658-D	25229	2" wheel, 2-1/2" overall height, 150 lb. load capacity, 1-11/16" swivel radius, 15/16" x 2-1/8" hole spacing, 1-7/8" x 2-9/16" top plate	1/0/50	.380	2.79 EA
239623-D	25230	2-1/2" wheel, 3-1/4" overall height, 220 lb. load capacity, 2-1/4" swivel radius, 1-3/4" x 3" hole spacing, 2-3/4" x 3-13/16" plate size	1/0/50	1.160	5.79 EA
239593-D	25231	3" wheel, 3-13/16" overall height, 270 lb. load capacity, 2-3/8" swivel radius, 2-3/8" x 3-3/8" hole spacing, 3-1/8" x 4-1/8" plate size	1/0/25	1.480	6.29 EA
239585-D	25276	4" wheel, 5" overall height, 350 lb. load capacity, 3-7/16" swivel radius, 1-3/4" x 2-15/16" hole spacing, 2-1/2" x 3-5/8" plate size	1/0/20	3.100	9.29 EA

Faultless Caster

Rigid Caster - Heavy-duty for general use in factories, stores, warehouses, farms, etc. Rubberex heavy-duty wheel.



Product No.	Mfg. No.	Description	Order Mult.	Weight	Unit Cost
203157-D	23770	2", 2-1/2" overall height, 90 lb. load capacity, 15/16" x 2-1/8" hole spacing, 1-1/2" x 2-21/32" plate size	1/0/50	.320	3.79 EA
203114-D	23772	2-1/2", 3-1/4" overall height, 90 lb. load capacity, 1-1/16" x 3-1/2" hole spacing, 2-1/4" x 4-7/16" plate size	1/0/50	.780	7.29 EA
203122-D	23774	3", 3-13/16" overall height, 175 lb. load capacity, 1-3/16" x 3-1/2" hole spacing, 2-1/2" x 4-15/16" plate size	1/0/25	1.280	8.49 EA
206156-D	23900	4", 5" overall height, 200 lb. capacity, 2-5/8" x 1-3/4" x 2-15/16" hole spacing, 2-1/2" x 3-5/8" plate size	1/0/20	2.000	11.99 EA
206164-D	23902	5", 6-1/8" overall height, 200 lb. capacity, 2-5/8" x 3" hole spacing, 2-1/2" x 3-5/8" plate size	1/0/10	4.000	15.49 EA

Faultless Caster

Rigid Caster - Heavy-duty for general use in factories, stores, warehouses, farms, etc. Polyflex wheel.



Product No.	Mfg. No.	Description	Order Mult.	Weight	Unit Cost
239364-D	25804	2" wheel, 2-1/2" overall height, 150 lb. load capacity, 15/16" x 2-1/8" hole spacing, 1-1/2" x 2-21/32" plate size	1/0/50	.360	2.49 EA
230170-D	25805	2-1/2" wheel, 3-1/4" overall height, 220 lb. load capacity, 1-1/16" x 3-1/2" hole spacing, 2-1/4" x 4-7/16" plate size	1/0/50	.840	4.79 EA
229032-D	25806	3" wheel, 3-13/16" overall height, 270 lb. load capacity, 1-3/16" x 3-1/2" hole spacing, 2-1/2" x 4-15/16" plate size	1/0/25	1.320	6.29 EA
227315-D	27327	4" wheel, 5" overall height, 350 lb. load capacity, 2-5/8" x 1-3/4" x 2-15/16" hole spacing, 2-1/2" x 3-5/8" plate size	1/0/20	2.150	8.29 EA

Faultless Caster

Swivel Caster - Extra heavy-duty for general use in factories, stores, warehouses, farms, etc. Polyflex wheel. 700 lb. load capacity. 6" swivel. 7-1/4" overall height, 2-3/4" x 3-1/4" hole spacing, 3-7/8" x 4-1/2" plate size. Cross Reference: Model No. 23700 108-2R, 23702 108-2-1/2R, 23704 108-3R, 23752 508-2R, 23753 508-2-1/2R, 23774 508-3R, 23848 14616, and 23872 34616.



Product No.	Mfg. No.	Description	Order Mult.	Weight	Unit Cost
225010-D	23848	6" Swivel Caster	1/0/4	4.500	37.99 EA

Faultless Caster

Rigid Caster - Extra heavy-duty for general use in factories, stores, warehouses, farms, etc. Polyflex wheel. 700 lb. load capacity. 6" rigid. 7-1/4" overall height, 2-3/4" x 3-1/4" hole spacing, 3-7/8" x 4-1/2" plate size. Cross Reference: Model No. 23700 108-2R, 23702 108-2-1/2R, 23704 108-3R, 23752 508-2R, 23753 508-2-1/2R, 23774 508-3R, 23848 14616, and 23872 34616.



Product No.	Mfg. No.	Description	Order Mult.	Weight	Unit Cost
225029-D	23872	6" Rigid Caster	1/0/4	4.000	25.99 EA

Faultless Caster

Swivel Caster - Heavy-duty for general use in factories, stores, warehouses, farms, etc. Sintered iron extra heavy-duty casters. Cross Reference: Model No. 23700 108-2R, 23702 108-2-1/2R, 23704 108-3R, 23752 508-2R, 23753 508-2-1/2R, 23774 508-3R, 23848 14616, and 23872 34616.



Product No.	Mfg. No.	Description	Order Mult.	Weight	Unit Cost
203068-D	23700	2", 2-1/2" overall height, 150 lb. load capacity, 2-1/2" swivel radius, 15/16" x 2-1/8" hole spacing, 1-7/8" x 2-9/16" plate size	1/0/50	.760	3.99 EA
203076-D	23702	2-1/2", 3-1/4" overall height, 200 lb. load capacity, 3-3/16" swivel radius, 1-3/4" x 3" hole spacing, 2-3/8" x 3-13/16" plate size	1/0/25	1.640	9.29 EA
225232-D	23704	3", 3-13/16" overall height, 300 lb. load capacity, 3-13/16" swivel radius, 2-3/8" x 3-3/8" hole spacing, 3-1/8" x 4-1/8" plate size	1/0/25	1.880	10.49 EA

Faultless Caster

Rigid Caster - Heavy-duty for general use in factories, stores, warehouses, farms, etc. Sintered iron extra heavy-duty casters. Cross Reference: Model No. 23700 108-2R, 23702 108-2-1/2R, 23704 108-3R, 23752 508-2R, 23753 508-2-1/2R, 23774 508-3R, 23848 14616, and 23872 34616.



Product No.	Mfg. No.	Description	Order Mult.	Weight	Unit Cost
203084-D	23752	2", 2-1/2" overall height, 150 lb. capacity, 15/16" x 2-1/8" hole spacing, 1-1/2" x 2-21/32" plate size	1/0/50	.640	3.79 EA
203092-D	23753	2-1/2", 3-1/4" overall height, 200 lb. capacity, 1-1/16" x 3-1/2" hole spacing, 2-1/4" x 4-7/16" plate size	1/0/25	1.440	7.99 EA
203106-D	23756	3", 3-13/16" overall height, 300 lb. capacity, 1-3/16" x 4" hole spacing, 2-1/2" x 4-15/16" plate size	1/0/25	1.640	10.49 EA

Faultless Caster

Threaded Stem Caster - Easy swiveling double ball bearing construction. Corrosion-resistant zinc. Use on metal furniture, carts, racks, and appliances. Rubberex nonmarking wheels.



Product No.	Mfg. No.	Description	Order Mult.	Weight	Unit Cost
203203-D	29390	2", 2-17/32" overall height, 80 lb. load capacity, 3/8" -16 x 1-1/2" stem	1/0/100	.375	6.29 EA
243582-D	23917	3", 3-1/2" overall height, 90 lb. load capacity, 3/8"-16 x 1-1/2" stem	1/0/50	.630	8.79 EA
243590-D	23919	4", 4-11/16" overall height, 115 lb. load capacity, 1/2"-13 x 1-1/2" stem	1/0/25	1.180	16.49 EA

Faultless Caster

Caster - Double ball bearing construction for heavy furniture, appliances, and equipment. Nickel finish. Rubberex wheel. 2" diameter; 80 lb. load capacity. Riveted axle. 7/16" stem diameter, 1-3/8" long. Stem size: 7/16" diameter x 1" L. Overall height 2-17/32".



Product No.	Mfg. No.	Description	Order Mult.	Weight	Unit Cost
203181-D	29384	2" Office Caster	1/0/200	.405	6.29 EA

Faultless Caster

Do it® Caster Insert - Used to adapt traditional wood stem style casters to aluminum or steel tubing applications. 4 per card.

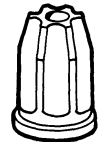

Product No.	Mfg. No.	Description	Order Mult.	Weight	Unit Cost
226548-D	32071	1/2" O.D., .430 I.D. tubing diameter, 1-7/16" minimum hole depth	1/0/10	.054	1.79 EA
202797-D	32182	5/8" O.D., .555 I.D. tubing diameter, 1-7/16" minimum hole depth, 3/4" bottom flange diameter	1/0/10	.088	1.79 EA
202800-D	32183	3/4" O.D., .680 I.D. tubing diameter, 1-7/16" minimum hole depth, 7/8" bottom flange diameter	1/0/10	.088	1.79 EA
202819-D	32184	7/8" O.D., .811 I.D. tubing diameter, 1-7/16" minimum hole depth, 29/32" bottom flange diameter	1/0/10	.088	1.79 EA
202835-C	32185	1" O.D., .930 I.D. tubing diameter, 1-1/2" minimum hole depth, 1.108 bottom flange diameter	1/0/10	.088	1.99 EA

HARDWARE

Faultless Caster

Caster Cup - Nonskid plastic. Protects hard floors. Clear. 4-pieces per card.



Product No.	Mfg. No.	Description	Order Mult.	Weight	Unit Cost
209929-D	32143	1-1/2" round	1/0/10	.125	1.99 EA
209937-D	32144	2" round	1/0/10	.175	2.29 EA
209945-D	32145	2-1/4" square	1/0/10	.200	2.29 EA

Faultless Caster

Do it® Nail-On Carpet Glide - Brown plastic glide with carpet base for use on straight wooden leg furniture. Protects all types of floors. Not recommended for seating applications. 4-pieces per card.



Product No.	Mfg. No.	Description	Order Mult.	Weight	Unit Cost
210129-D	32161	1" diameter	1/0/10	.075	2.29 EA
210137-D	32162	1-1/4" diameter	1/0/10	.100	2.49 EA

Faultless Caster

Do it® Vinyl Leg Tip - High tip. Fits round metal or wood legs to protect floors. Tips work on angles or straight legs. Black or white. 4-pieces per card.



Product No.	Mfg. No.	Description	Order Mult.	Weight	Unit Cost
226904-D	32075	1/2" white	1/0/10	.079	1.29 EA
209392-D	32100	5/8" white	1/0/10	.050	1.29 EA
209406-E	32101	3/4" white	1/0/10	.050	1.49 EA
209414-D	32102	7/8" white	1/0/10	.070	1.49 EA
209422-D	32103	1" white	1/0/10	.070	1.49 EA
209430-D	32104	1-1/8" white	1/0/10	.090	2.29 EA
226785-D	32077	1/2" black	1/0/10	.076	1.29 EA
209449-D	32105	5/8" black	1/0/10	.050	1.29 EA
209457-E	32106	3/4" black	1/0/10	.050	1.49 EA
209473-D	32107	7/8" black	1/0/10	.070	1.49 EA
209481-D	32108	1" black	1/0/10	.070	1.49 EA
209503-D	32109	1-1/8" black	1/0/10	.090	2.29 EA

Faultless Caster

Do it® Bulk-Rubber Leg Tip - Fits round metal or wooden legs to protect floors. Tips work on angled or straight legs. 40-pieces per carton.



Product No.	Mfg. No.	Description	Order Mult.	Weight	Unit Cost
214361-E	31974	1/2" black	0/0/40	.050	.39 EA
214353-E	31975	1/2" white	0/0/40	.050	.39 EA
214345-E	31976	5/8" black	0/0/40	.063	.39 EA
214337-E	31977	5/8" white	0/0/40	.063	.39 EA
214329-E	31978	3/4" black	0/0/40	.088	.39 EA
214221-E	31979	3/4" white	0/0/40	.088	.39 EA
214248-E	31980	7/8" black	0/0/40	.100	.39 EA
214256-E	31981	7/8" white	0/0/40	.100	.39 EA
214264-E	31982	1" black	0/0/40	.125	.49 EA
214272-E	31983	1" white	0/0/40	.125	.49 EA
214280-E	31984	1-1/8" black	0/0/40	.138	.49 EA

Continued Next Column

CASTER

Continued From Previous Column

Product No.	Mfg. No.	Description	Order Mult.	Weight	Unit Cost
214299-E	31985	1-1/8" white	0/0/40	.138	.49 EA
214302-D	31986	1-1/4" black	0/0/40	.150	.49 EA
214310-D	31987	1-1/4" white	0/0/40	.150	.49 EA

Faultless Caster

Do it® Feltac Round Felt Pad - Protects furniture, floors, and walls. Makes furniture easier to move. Beige. Ultra-strength pressure sensitive adhesive ensures adherence to any surface. Optimum fibre density ensures long term durability. Rigid fibre eliminates displacement of felt pad under furniture.

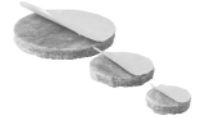

Product No.	Mfg. No.	Description	Order Mult.	Weight	Unit Cost
239348-D	23069	3/4" diameter, 24-pieces per card	1/10/50	.080	3.49 EA
239259-D	23061	1-1/8" diameter, 16-pieces per card	1/10/50	.080	3.49 EA
239267-D	23062	1-7/8", diameter 6-pieces per card	1/10/50	.080	3.49 EA
236845-D	23083	1" diameter, heavy-duty, 16-pieces per card	1/10/50	.050	3.29 EA
237167-D	23084	1-1/2" diameter, heavy-duty, 8-pieces per card	1/10/50	.050	3.29 EA
237817-D	23085	1" square, heavy-duty, 24-pieces per card	1/10/50	.063	3.29 EA

Faultless Caster

Do it® Feltac Round Felt Pad With Nylon Disc - Nylon reinforcement disc holds pad under irregular furniture legs. 8 per card. Ultra-strength pressure sensitive adhesive ensures adherence to any surface. Optimum fibre density ensures long term durability. Rigid fibre eliminates displacement of felt pad under furniture.

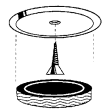

Product No.	Mfg. No.	Description	Order Mult.	Weight	Unit Cost
239291-D	23065	White, 1-1/8" diameter	1/10/50	.080	3.49 EA
239305-D	23066	Black, 1-1/8" diameter	1/10/50	.080	3.49 EA
240370-D	23080	White, 3/4" diameter	1/10/50	.056	3.29 EA

Faultless Caster

4" x 6-1/2" Sheet Feltac™ Ultra Pad - Protect your investment in your home and furnishings - both floors and furniture legs. Reduce irritating *screeches and unsightly scratches* when moving furniture. Combine the rugged durability of commercial strength Velcro™ with the gentle protection of heavy-duty cushioned felt. Install on furniture legs - chairs, couches, tables, china cabinets, servers, desk, credenzas, etc. For use on ceramic, hardwood, laminate, terrazzo, vinyl, or sealed concrete floor surfaces. Quick and easy installation - just *peel and stick*. Neutral color felt pads (beige) blend in with but do not detract from floors or furniture. Inspect pads periodically for wear, replace as required. Package contains: 2 Feltac sheets and 1 Velcro™ sheet.



Product No.	Mfg. No.	Description	Order Mult.	Weight	Unit Cost
212202-D	23234	4x6-1/2 Felt Sheet	1/0/10	.216	6.99 CD

Faultless Caster

Feltac™ Ultra Self-Adhesive Pads - Protect your investment in your home and furnishings - both floors and furniture legs. Reduce irritating *screeches and unsightly scratches* when moving furniture. Combine the rugged durability of commercial strength Velcro™ with the gentle protection of heavy-duty cushioned felt. Install on furniture legs - chairs, couches, tables, china cabinets, servers, desk, credenzas, etc. For use on ceramic, hardwood, laminate, terrazzo, vinyl, or sealed concrete floor surfaces. Quick and easy installation - just *peel and stick*. Neutral color felt pads (beige) blend in with but do not detract from floors or furniture. Inspect pads periodically for wear, replace as required. Package contains enough for initial installation and 1 set of replacements.



Product No.	Mfg. No.	Description	Order Mult.	Weight	Unit Cost
212246-D	23231	3/4" 12 Velcro™ self-adhesive attachments and 24 heavy-duty Feltac™ pads	1/0/10	.068	5.49 CD
212228-D	23232	1" 8 Velcro™ self adhesive attachments and 16 heavy-duty Feltac™ pads	1/0/10	.068	5.49 CD
212219-D	23233	1-7/8" 4 Velcro™ self-adhesive attachments and 8 heavy-duty Feltac™ pads	1/0/10	.098	5.49 CD

Faultless Caster

Do it® Feltac Felt Strip - 1/2" x 2-5/8" precut narrow strip. Protects rocking chairs, tubular furniture and other metal surfaces. 16 per card. Beige. Ultra-strength pressure sensitive adhesive ensures adhesion to any surface. Optimum fibre density ensures long term durability. Rigid fibre eliminates displacement of felt pad under furniture.

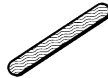

Product No.	Mfg. No.	Description	Order Mult.	Weight	Unit Cost
239321-D	23068	2-5/x1/2 Felt Strip	1/10/50	.080	3.49 EA

**WHAT You
NEED
WHEN You
NEED It!**

